

YAMAHA

ROBOT



Estratto Catalogo Yamaha
Assi lineari alte prestazioni (Serie Flip-X)

FLIP-X Series

Product Lineup

SINGLE-AXIS ROBOTS

General-purpose single-axis robots can be used for various applications, such as assembly and inspection work.

6 types and 29 models ranging from compact size to long-stroke robots are available.



Various custom specifications are also supported.

Various custom specifications, such as double-slider and wide slider are also supported.
For details, please consult YAMAHA.

Six types with high reliability and durability

T type Frame-less structure model P.174

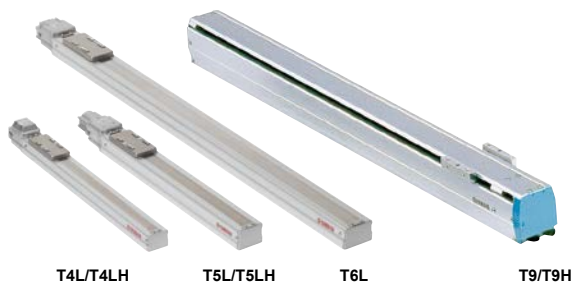

- Double appeal of compact body and low price.
- Ideal in applications as an actuator directly installed on an installation base.

F type Model with high rigidity frame P.181

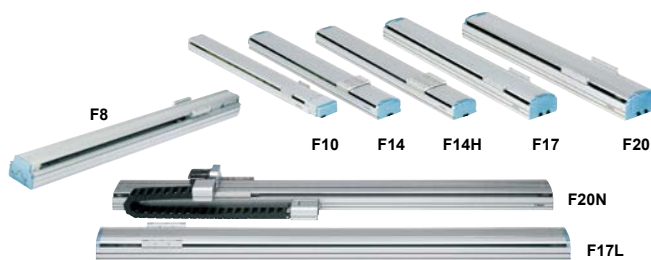

- Tolerable load moment is large and highly resistant to the offset load.
- Suitable for Cartesian robots needing rigid arm or moving arms that move the entire axis.

R type Rotation axis model P.212



- Repeated positioning accuracy +/- 30 sec. (0.0083 °)
- The robot can be used as the rotation axis when combined with other robots or utilized for a wide variety of applications, such as index tables.
- High rigidity and high accuracy by harmonic drive.

GF type Long stroke model with high rigidity frame P.190

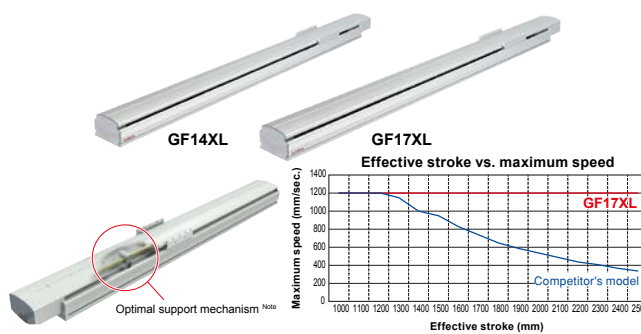

- Movable at 1200 mm/sec. in the whole area without critical speed.
- Suitable for long distance transfer.

N type Nut rotation type model P.198

- Repeated positioning accuracy +/- 0.01 mm
- Maximum payload 80 kg
- Double-carrier available as a standard

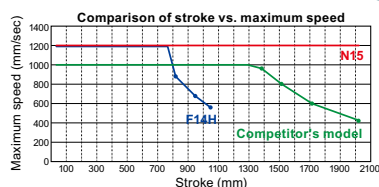
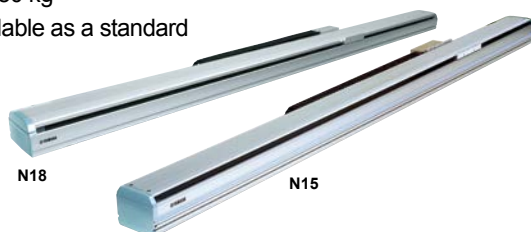

Critical speed is not restricted and high-speed transfer is possible.
Stroke: 2500 mm
Maximum speed: 1200 mm/sec.

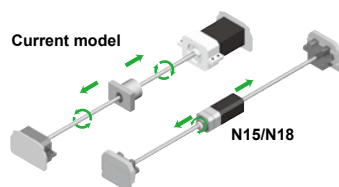

In this structure, the hollow motor is connected to the nut of the ball screw and the nut is rotated with the screw shaft secured to perform the movement.

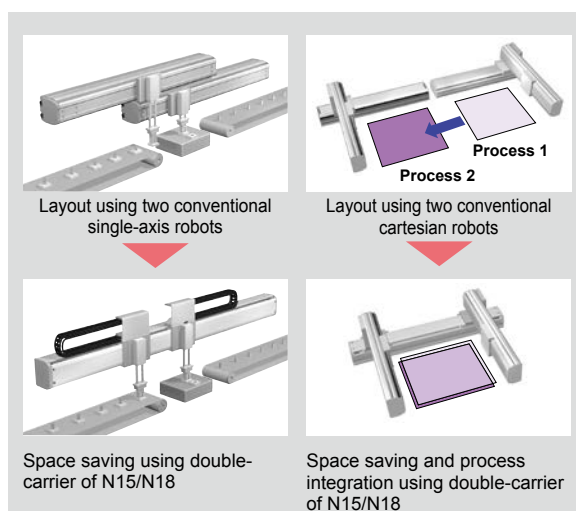

B type Timing belt drive model P.206

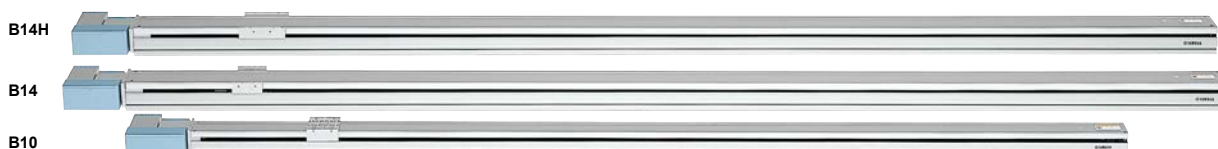

- Maximum stroke is 3050 mm. Long-distance transfer between the processes is possible.

POINT 1

4-row circular arc groove type 2-point contact guide that is resistant to large moment load is adopted. ^{Note 1}



4-row circular arc groove type 2-point contact guide with less differential slip is used for the linear guide. This guide has less ball differential slip due to its structure when compared to the 2-row Gothic arch type 4-point contact guide and maintains a satisfactory rolling movement even if a large moment load is applied or the installation surface precision is poor. The guide has characteristics that are difficult to malfunction, such as unusual wear and provides excellent reliability.

Note 1. Except for T4L/T4LH and T5L/T5LH

2-row gothic arch groove type 4-point contact guide

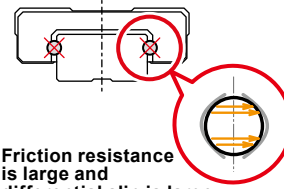

Friction resistance is large and differential slip is large.

- Easy to receive adverse effects of installation surface accuracy, friction, and elastic deformation.
- Breakage may occur before expiration of calculation service life.

4-row circular arc groove type 2-point contact guide

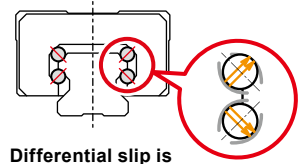

Differential slip is small and self-centering function is high.

- Resistant to alignment changes and moment loads.
- Difficult to break.

F/N/B type ^{Note 2}

For the F type, N type, and B type, two guide frames are laid out on the high rigidity aluminum extruded material frame. Two bearing units per rail, four bearing units in total, support a large load firmly. As a large moment load is mainly converted into vertical force, the moment applied to one bearing unit becomes small to ensure excellent durability.

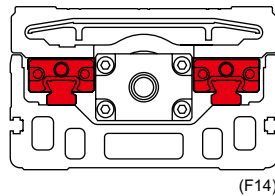

(F14)

Note 2. Except for F8 series/F10/B10.

F8 series

The F8 series uses a newly developed module guide to greatly reduce the cross-sectional area (70 % when compared to F10). The rail is laid out in the full width of the frame to ensure the high rigidity even with compact design. Of course, this series also uses the 4-row circular arc groove type 2-point contact guide.

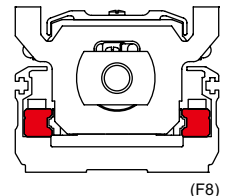

(F8)

POINT 2

Resolver with excellent environment resistance is used for the position detector.

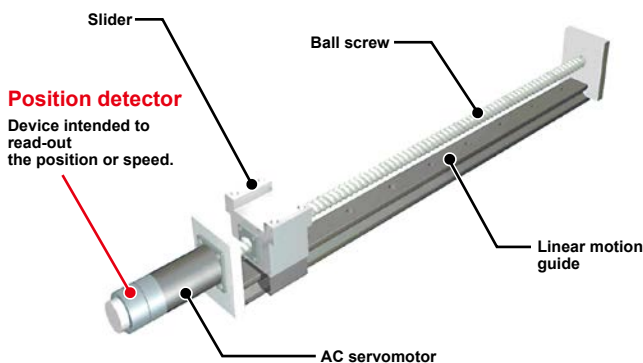

Position detector
Device intended to read-out the position or speed.

Optical encoder



- Optical type
- Electronic components are required and structure is complicated.
- Damaged easily by electronic component breakdown, dew condensation on or oil sticking to the disk.

Detection failure

Resolver



- Magnetic type
- Simple structure only with iron core and winding has less potential failure factors.
- Immune to shock and electric noise.

High reliability

A resolver is used for the position detector. The resolver has a simple and rigid structure without using electronic components and optical elements. Detection problems due to electronic component breakdown, dew condensation on or oil sticking to the disk that may occur in optical encoders do not occur in the resolver. The resolver provides excellent durability. Additionally, as the absolute specifications and incremental specifications use the same mechanical specifications and common controller, desired specifications can be selected only by setting parameters. Furthermore, even when the absolute battery is consumed completely, the robot can still operate as the incremental specifications. So, even if a trouble occurs, the line stop is not needed to ensure the safe production line. Furthermore, the backup circuit has been completely renovated and now has a backup period of one year in the non-energizing state.

POINT 3

Long service life greatly reduces the maintenance cost.

As the acceleration is determined by the weight parameter, the service life can be assured when the weight and position of center of gravity are known.

Allowable overhang Note

Horizontal installation (Unit: mm)				Wall installation (Unit: mm)				Vertical installation (Unit: mm)			
	A	B	C		A	B	C		A	C	
Lead 30	5kg	864	501	383	5kg	348	384	776	1kg	600	600
	15kg	491	156	140	15kg	87	40	306	2kg	1098	1098
Lead 20	5kg	1292	505	462	5kg	416	388	1186	4kg	545	545
	15kg	572	158	151	15kg	92	42	386	4kg	594	594
	30kg	455	73	75	30kg	0	0	61	8kg	280	280
Lead 10	20kg	617	119	127	10kg	193	132	910	10kg	217	217
	40kg	422	53	59	20kg	53	0	400	10kg	221	221
	55kg	420	36	40	30kg	0	0	109	15kg	135	135
Lead 5	50kg	722	42	47	10kg	197	133	2360	20kg	92	92
	60kg	657	33	37	20kg	54	0	985			
	80kg	577	23	25	30kg	0	0	427			

Note. Distance from center of slider top to center of gravity of object being carried at a guide service life of 10,000 km.

As YAMAHA's robot uses high rigidity ball screw or guide, it provides excellent durability. This greatly contributes to reduction of the customer's maintenance cost.

Cost reduction by high durability

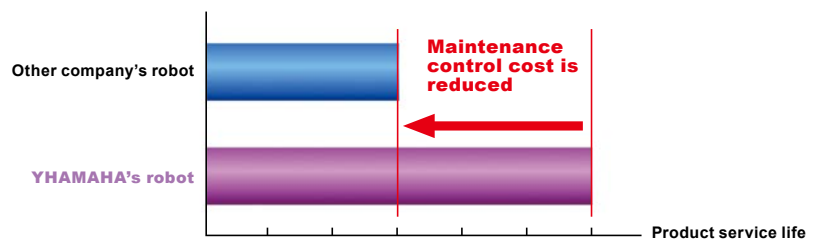

POINT 4

Controllers suitable for applications are prepared.

In addition to the robot program operation and pulse train control, a positioner that is operated by specifying a point number was added to the product lineup. Additionally, multi specifications that control multiple robots using one controller are also supported. You can select an optimal controller suitable for your application.

Program				I/O point trace (Positioner)	Pulse-train control
SR1-X	RCX222	RCX240/ RCX240S	RCX340	TS-X	RDV-X
P.516	P.524	P.532	P.542	P.490	P.504

POINT 5

Various custom specifications are supported.

YAMAHA supports custom orders flexibility to meet the customers' various needs.

Addition of free slider	Free slider is added. Various applications, such as rigidity increase or use of two heads are supported.
Wide slider	To increase the slider rigidity, the standard slider is processed to the wide slider.
Specified stroke	A stroke smaller than the minimum stroke may be supported. For details, please consult YAMAHA.
Lead beyond catalog	The lead may be changed to that not stated in the catalog. For details, please consult YAMAHA.
Origin non-motor specifications	Even when not stated in the catalog, the origin may be changed to the non-motor side. For details, please consult YAMAHA.

YAMAHA has a wide variety of custom order results other than those shown above. If you have any requirement or request, please feel free to contact YAMAHA.

Type	Size (mm) ^{Note 1}	Model	Lead (mm)	Maximum payload (kg)		Maximum speed (mm/sec.)	Stroke (mm)	Page
				Horizontal	Vertical			
T type Frame-less structure model	W45 × H53	T4L/T4LH	12	4.5	1.2	720	50 to 400	T4L: P.174
			6	6	2.4	360		T4LH: P.175
			2	6	7.2	120		
	W55 × H52	T5L/T5LH	20	3	-	1200	50 to 800	T5L: P.176
			12	5	1.2	800		T5LH: P.177
			6	9	2.4	400		
	W65 × H56	T6L	20	10	-	1333	50 to 800	P.178
			12	12	4	800		
			6	30	8	400		
	W94 × H98	T9 (Standard)	30	15	-	1800	150 to 1050	P.179
			20	30	4	1200		
			10	55	10	600		
			5	80	20	300		
		T9H (High thrust)	30	25	-	1800	150 to 1050	P.180
			20	40	8	1200		
10			80	20	600			
5			100	30	300			
F type Model with high rigidity frame	W80 × H65	F8	20	12	-	1200	150 to 800	P.181
			12	20	4	720		
			6	40	8	360		
	W80 × H65	F8L	30	7	-	1800	150 to 1050	P.182
			20	20	4	1200		
			10	40	8	600		
			5	50	16	300		
	W80 × H65	F8LH	20	30	-	1200	150 to 1050	P.184
			10	60	-	600		
			5	80	-	300		
	W110 × H71	F10 (Standard)	30	15	-	1800	150 to 1050	P.185
			20	20	4	1200		
			10	40	10	600		
		NEW F10H (High thrust)	30	25	-	1800	150 to 1000	P.186
			20	40	8	1200		
			10	80	20	600		
			5	100	30	300		
	W136 × H83	F14 (Standard)	30	15	-	1800	150 to 1050	P.188
			20	30	4	1200		
			10	55	10	600		
			5	80	20	300		
		F14H (High thrust)	30	25	-	1800		P.189
			20	40	8	1200		
			10	80	20	600		
	W168 × H100	F17L	50	50	10	2200	1100 to 2050	P.193
			40	40	-	2400	200 to 1450	P.191
		F17	20	80	15	1200	200 to 1250	
10			120	35	600			
W202 × H115	F20	40	60	-	2400	200 to 1450	P.195	
		20	120	25	1200			
		10	-	45	600			
W202 × H120	F20N	20	80	-	1200	1150 to 2050	P.197	
GF type	W140 × H91.5	GF14XL	20	45	-	1200	750 to 2000	P.190
	W168 × H105.5	GF17XL	20	90	-	1200	850 to 2500	P.194
N type Nut rotation type model	W145 × H120	N15 (Single-carrier)	20	50	-	1200	500 to 2000	P.198
		N15D (Double-carrier)					250 to 1750	P.200
	W180 × H115	N18 (Single-carrier)		80	-		500 to 2500	P.202
		N18D (Double-carrier)					250 to 2250	P.204
B type Timing belt drive model	W100 × H81	B10	Belt drive	10	-	1875	150 to 2550	P.206
	W146 × H94	B14 (Standard)	Belt drive	20	-	1875	150 to 3050	B14: P.208
		B14H (High thrust)	Belt drive	30	-	1875		B14H: P.210
R type Rotation axis model	-	R5	-	0.12 kgm ²	-	360 °/sec	360 °	P.212
		R10		0.36 kgm ²	-			P.213
		R20		1.83 kgm ²	-			P.214

Note 1. The size shows approximate maximum cross sectional size.

Multi-robot

MULTI-FLIP/MULTI-PHASER

This robot has multi specifications that control multiple robots using one controller.

Advantages of control with multi-axis controller

- Sequence control is easy. System upgrades are easy at less expensive price.
- Compact and space saving when compared to the operation with multiple single-axis controllers.
- More advanced control is possible.
- RCX221, RCX240, RCX240S, and RCX340 provide mixed control of the FLIP-X series and PHASER series (linear single-axis).

Multi-robot ordering method

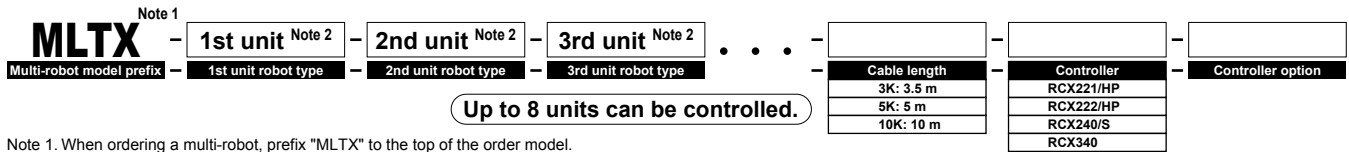

Note 1. When ordering a multi-robot, prefix "MLTX" to the top of the order model.
 Note 2. Select either MULTI-FLIP or MULTI-PHASER shown below.
 Note 3. For details about the controller and controller option models, please refer to relevant page of each controller.

MULTI-FLIP

Type	Model	Lead (mm)	Stroke (mm)
T type Frame-less structure model	T4L/T4LH	12	50 to 400
		6	
		2	
	T5L/T5LH	20	50 to 800
		12	
		6	
	T6L	20	50 to 800
		12	
		6	
	T9 (Standard)	30	150 to 1050
		20	
		10	
T9H (High thrust)	5	150 to 1050	
	30		
	20		
F type Model with high rigidity frame	F8	12	150 to 800
		6	
		30	
	F8L	20	150 to 1050
		10	
		5	
	F8LH	20	150 to 1050
		10	
		5	
	F10 (Standard)	30	150 to 1050
		20	
		10	
NEW F10H (High thrust)	5	150 to 1000	
	30		
	20		
F14 (Standard)	10	150 to 1050	
	5		
	30		
F14H (High thrust)	20	150 to 1050	
	10		
	5		
F17L	50	1100 to 2050	
	40	200 to 1450	
	20	200 to 1250	
F17	10	200 to 1250	
	20		
	40		
F20	20	200 to 1450	
	10	200 to 1250	
	20	200 to 1250	
F20N	20	1150 to 2050	
	20	750 to 2000	
	20	850 to 2500	
GF type	GF14XL	20	750 to 2000
N type Nut rotation type model	N15 (Single-carrier)	20	500 to 2000
	N15D (Double-carrier)		250 to 1750
	N18 (Single-carrier)		500 to 2500
	N18D (Double-carrier)		250 to 2250
B type Timing belt drive model	B10	Belt drive	150 to 2550
	B14 (Standard)	Belt drive	150 to 3050
	B14H (High thrust)	Belt drive	
R type Rotation axis model	R5	-	360 °
	R10		
	R20		

MULTI-PHASER

Type	Model	Carrier	Stroke (mm)
MF type Flat type with core Linear motor specifications	MF7	Single	100 to 4000
	MF7D	Double	100 to 3800
	MF15	Single	300 to 4000
	MF15D	Double	100 to 3800
	MF20	Single	150 to 4050
	MF20D	Double	150 to 3850
	MF30	Single	100 to 4000
	MF30D	Double	150 to 3750
	MF75	Single	1000 to 4000
	MF75D	Double	680 to 3680
MR type Shaft type Linear motor specifications	MR12	Single	50 to 1050
	MR12D	Double	50 to 1050

Robot settings

2-robot settings

Use of 2-robot settings and multi-task program makes it possible to perform asynchronous independent operation. As the auxiliary axis setting is used together, more free axis assignment can be made.

Double-carrier

In robot types that the motor runs separately, such as linear motor single-axis PHASER series or N type (nut rotation type) of FLIP-X series, two motors can be added to one axis.

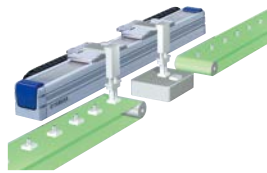

Main auxiliary axis setting



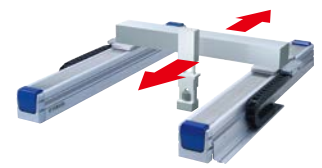

This auxiliary axis setting is used when it is inconvenient that two axes move simultaneously by the MOVE command. The axis set for the main auxiliary axis does not operate by the MOVE command and it operates only by the DRIVE command (movement command in axis units). This setting is recommended for the axis that needs to be operated asynchronously from the main robot.

Dual setting

This setting is used when performing the dual drive (2-axis synchronous control). This setting is used when the gantry type Cartesian robot with a long Y-axis stroke stabilizes the high acceleration/deceleration or when a high load or high thrust is needed.



Applicable controllers

Name	1 to 2 axes controller		1 to 4 axes controller	1 to 4 axes controller
	RCX221	RCX222	RCX240/RCX240S	RCX340
Appearance	 P.524	 P.524	 P.532	 P.542
Position detection	Incremental	Absolute	Incremental/Absolute	Incremental/Absolute
Control model	FLIP-X and PHASER can be mixed.	FLIP-X	FLIP-X and PHASER can be mixed.	FLIP-X and PHASER can be mixed.
Maximum number of programs	100 programs		100 programs	100 programs
Maximum number of points	10,000 points		10,000 points	30,000 points
Number of input/output points	Standard	Dedicated input 10 points/ dedicated output 12 points General-purpose input 16 points/ general-purpose output 8 points	Dedicated input 10 points/ dedicated output 11 points General-purpose input 16 points/ general-purpose output 8 points	Dedicated input 8 points/ dedicated output 9 points General-purpose input 16 points/ general-purpose output 8 points
	Expansion	General-purpose input 24 points/ general-purpose output 16 points	General-purpose input 24 points/ general-purpose output 16 points	General-purpose input 24 points/ general-purpose output 16 points
Network option	CC-Link, DeviceNet™, Ethernet, PROFIBUS		CC-Link, DeviceNet™, EtherNet/IP™, Ethernet, PROFIBUS	CC-Link, DeviceNet™, EtherNet/IP™, Ethernet, PROFIBUS, PROFINET

Examples of multi-robot ordering methods

Separate single axes

<Example> F14H and F10 are installed separately.

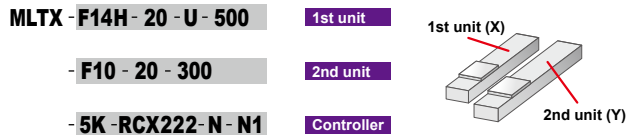

2 axes + 1 axis

<Example> T6 is installed on the base for the 1st axis, C6 is secured to the upper portion for the 2nd axis, and CH4 is secured to the upper portion for the 3rd axis to assemble the C6 and C4H to the XZ. (Either 2 axes + 1 axis or 3 axes simultaneous control can be made by the setting.)

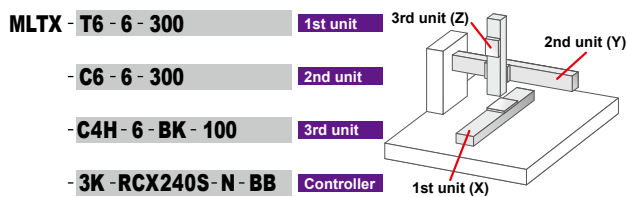

Note. When the customer combines each axis, it is recommended to use the cable terminal (relay cable) for the wiring among axes. For details about cable terminal, please contact YAMAHA.

3 axes combination

<Example> C17L, C14H, and C14H are used for the X-axis, Y-axis, and Z-axis, respectively to form a 3-axis XYZ combination.

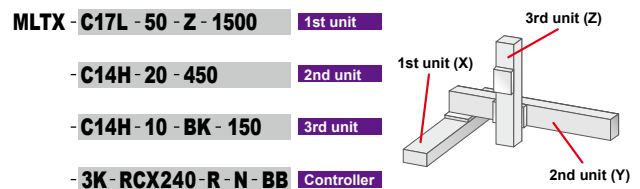

Double-carrier

Example of 4-axis control

<Example> Two T6 are assembled to the double-carrier of the MF20A, and they are used as XZ type and controlled using one controller.

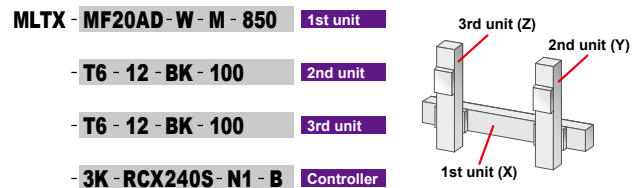

Note. For the double-carrier, since one robot occupies two axes of the controller, the number of robots may differ from the number of controllable axes.

Double-carrier/dual drive (2-axis simultaneous control)

Example of 8-axis control

<Example> Two double-carriers of the MF30 are arranged in parallel and two MF20 installed on the top are moved by the dual-drive. T6 is attached to each tip of the MF20 and the robots are controlled using two controllers.

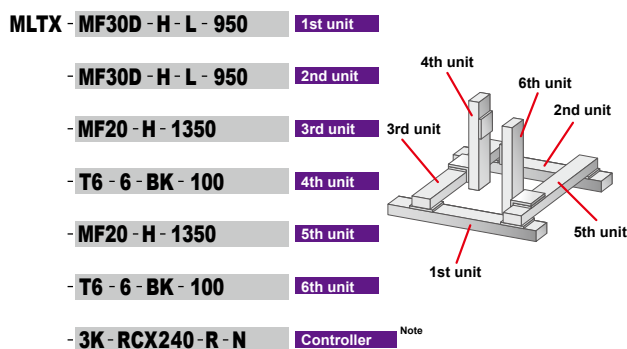

Note. For this specification, when writing one controller model, two controller will be arranged automatically.

CAUTION

Conditions needing regenerative unit on multi-robot

- The total motor capacity exceeds 450 W.
- The total motor capacity of the vertical axis exceeds 240 W.
- The B14H performs the operation at a maximum speed of more than 1250 mm/s.
- When the vertical axis is 240 W or less, the conditions shown below are satisfied.
 - There is a 200 W-vertical axis.
 - A 100 W-vertical axis has a stroke of 700 mm or more.
 - There are two 100 W-vertical axes with a 5 mm-lead.

FLIP-X terminology

High lead

This term indicates models supporting ball screw leads that exceed the standard lead (12 mm or 20 mm). (The standard lead of the F17L and C17L is 50.)

Origin on non-motor side

This term indicates models that are applicable to the origin non-motor specifications as standard. The origin on the non-motor side in the standard state is not supported with a lead not stated in the catalog. If special specifications are needed, please consult YAMAHA.

Maximum speed

This term indicates the maximum transfer speed. YAMAHA's single-axis robots can transfer a workpiece at this speed regardless of the transfer weight as long as it is within the maximum payload. However, as the workpiece is heavier, the acceleration/deceleration curve becomes gentle. If the movement distance is short, the speed does not reach the maximum speed stated in the catalog.

CAUTION

When the stroke of the ball screw drive type is long, noise or vibration is produced due to resonance of the ball screw if moved at the maximum speed. If this happens, lower the speed to that stated in the note column. (It is also possible to lower the transfer speed of the entire program using the SPEED setting or make the adjustment for each movement command.)

Maximum payload

This term indicates the maximum weight that can be loaded on the slider and transferred. Select an appropriate model so that the total weight of the customer's tools (air cylinder or chuck) and workpiece is less than this data. When the center of gravity of the tool or workpiece is offset from the center of the slider, the allowable overhang needs to be taken into consideration. Additionally, when entering the total weight of the tool and workpiece for the payload parameter of the controller, optimal acceleration/deceleration and servo parameter are automatically set.

Rated thrust

This term indicates the force to be applied in the slider advancing direction in the slider stationary (hold) state. When using vertically, the weight of the loaded workpiece is subtracted from this value (when the force is applied downward from the top). The slider can move only at a low speed (approximately 10 % of the maximum speed), but this value becomes lower than the specification value. Additionally, the type B of the timing belt drive cannot be used for applications, in which thrust is applied.

Allowable overhang

This term indicates an allowable overhang of an object to be transferred. In the specification data, this indicates the distance from the center of the top face of the slider to the center of gravity of an object to be transferred by the weight. This value is determined according to the service life of the linear guide. Under normal operation conditions^{Note}, the 90 %-service life of the linear guide is 10,000 km or more if gravity centers of the workpiece and tool are kept within the allowable overhang. When using with an overhang amount exceeding the specification data, it is necessary to install a separate support guide or restrict operating conditions (speed, acceleration) so that a load is not applied to the linear guide of the single-axis robot. For detail, please consult YAMAHA.

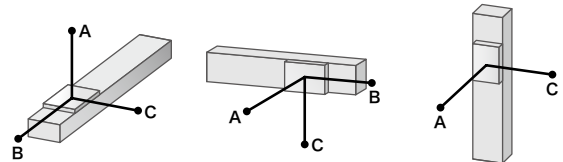

Note. Speed, acceleration 100 % (It is preconditioned that the weight parameters are set correctly.)
There shall be no impact load or excessive vibration during operation.
Additionally, the alignment is correct.

Static tolerance moment

This term indicates the load moment applied to the slider in the robot stationary state.

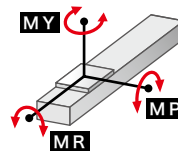

Critical speed

When the stroke of the ball screw drive type is long, noise or vibration is produced due to resonance of the ball screw if moved at the maximum speed. If this happens, lower the speed to that stated in the note column. (It is also possible to lower the transfer speed of the entire program using the SPEED setting or make the adjustment for each movement command.)



Articulated robots
YA



Linear conveyor modules
LCM100

Compact single-axis robots
TRANSERVO



Single-axis robots
FLIP-X

Linear motor single-axis robots
PHASER



Cartesian robots
XY-X

SCARA robots
YK-X

Pick & place robots
YP-X

CLEAN

CONTROLLER

INFORMATION

T type

F type

GF type

N type

B/R type

SINGLE-AXIS ROBOTS

FLIP-X

SERIES

CONTENTS

<ul style="list-style-type: none"> ■ FLIP-X SPECIFICATION SHEET 170 ■ Robot ordering method description 172 ■ Robot ordering method terminology 173 	<ul style="list-style-type: none"> F17L 193 GF17XL 194 F20 195 F20N 197
<ul style="list-style-type: none"> T TYPE FRAME-LESS STRUCTURE MODEL T4L 174 T4LH 175 T5L 176 T5LH 177 T6L 178 T9 179 T9H 180 	<ul style="list-style-type: none"> N TYPE NUT ROTATION TYPE MODEL N15 198 N15D 200 N18 202 N18D 204
<ul style="list-style-type: none"> F TYPE / GF TYPE HIGH RIGIDITY FRAME MODEL F8 181 F8L 182 F8LH 184 F10 185 F10H 186 F14 188 F14H 189 GF14XL 190 F17 191 	<ul style="list-style-type: none"> B TYPE TIMING BELT DRIVE MODEL B10 206 B14 208 B14H 210 R TYPE ROTATION AXIS TYPE MODEL R5 212 R10 213 R20 214

FLIP-X SPECIFICATION SHEET

Type	Model	Motor output (W)	Repeat-ability (mm)	Lead (mm)	Payload (kg)		Stroke (mm) and maximum speed (mm/s)																					
					Horizontal	Vertical	50	100	150	200	250	300	350	400	450	500	550	600	650	700	750	800	850	900	950	1000		
T type	T4L/T4LH	30	+/-0.02	12	4.5	1.2	720																					
				6	6	2.4	360																					
				2	6	7.2	120																					
	T5L/T5LH	30	+/-0.02	20	3	-	1200										960	840	720	660								
				12	5	1.2	800										640	560	480	440								
				6	9	2.4	400										320	280	240	220								
	T6L	60	+/-0.02	20	10	-	1333										1133	1000	866	800								
				12	12	4	800										680	600	520	480								
				6	30	8	400										340	300	260	240								
	T9	100	+/-0.01	30	15	-	1800										1440			1170			900					
				20	30	4	1200										960			780			600					
				10	55	10	600										480			390			300					
5				80	20	300										240			195			150						
T9H	200	+/-0.01	30	25	-	1800										1440			1170			900						
			20	40	8	1200										960			780			600						
			10	80	20	600										480			390			300						
			5	100	30	300										240			195			150						
F type	F8	100	+/-0.02	20	12	-	1200										1080	900	780	720	600							
				12	20	4	720										648	540	468	432	360							
				6	40	8	360										324	270	234	216	180							
	F8L	100	+/-0.01	30	7	-	1800										1530	1350	1170	1080	990	900	810					
				20	20	4	1200										1020	900	780	720	660	600	540					
				10	40	8	600										510	450	390	360	330	300	270					
				5	50	16	300										255	225	195	180	165	150	135					
	F8LH	100	+/-0.01	20	30	-	1200										1020	900	780	720	660	600	540	480				
				10	60	-	600										510	450	390	360	330	300	270	240				
				5	80	-	300										255	225	195	180	165	150	135	120				
	F10	100	+/-0.01	30	15	-	1800										1440			1170			900					
				20	20	4	1200										960			780			600					
10				40	10	600										480			390			300						
5				60	20	300										240			195			150						
F10H	200	+/-0.01	30	25	-	1800										1440	1260	1080	900	720	630							
			20	40	8	1200										960	840	720	600	480	420							
			10	80	20	600										480	420	360	300	240	210							
			5	100	30	300										240	210	180	150	120	105							
F14	100	+/-0.01	30	15	-	1800										1440			1170			900						
			20	30	4	1200										960			780			600						
			10	55	10	600										480			390			300						
			5	80	20	300										240			195			150						
F14H	200	+/-0.01	30	25	-	1800										1440			1170			900						
			20	40	8	1200										960			780			600						
			10	80	20	600										480			390			300						
			5	100	30	300										240			195			150						
F17	400	+/-0.01	40	40	-	2400										1920			1680									
			20	80	15	1200										960			840									
			10	120	35	600										480			420									
F17L	600	+/-0.02	50	50	10																							
F20	600	+/-0.01	40	60	-	2400										1920			1680									
			20	120	25	1200										960			840									
			10	-	45	600										480			420									
F20N	400	+/-0.04	20	80	-																							
GF type	GF14XL	200	+/-0.01	20	45	-																						
	GF17XL	400	+/-0.01	20	90	-																						
N type	N15	400	+/-0.01	20	50	-																						
	N15D	400	+/-0.01	20	50	-																						
	N18	400	+/-0.01	20	80	-																						
	N18D	400	+/-0.01	20	80	-																						
B type	B10	100	+/-0.04	-	10	-																						
	B14	100	+/-0.04	-	20	-																						
	B14H	200	+/-0.04	-	30	-																						

Type	Model	Motor output (W)	Repeat-ability (sec)	Speed reduction ratio	Maximum speed (°/sec)	Detailed info page
R type	R5	50	+/-30	1/50	360	P.212
	R10	100	+/-30	1/50	360	P.213
	R20	200	+/-30	1/50	360	P.214

⚠ Precautions for use

- **Handling**
Fully understand the contents stated in the "FLIP-X Series User's Manual" and strictly observe the handling precautions during operation.
- **Allowable installation ambient temperature**
0 to 45 °C

	1050	1100	1150	1200	1250	1300	1350	1400	1450	1500 to 1600	1650	1700	1750	1800	1850 to 2000	2050	2150	2250	2350	2400 to 2500	2550	2650 to 3050	Detailed info page		
																								T4L: P.174 T4LH: P.175	
																								T5L: P.176 T5LH: P.177	
																								P.178	
	810																							P.179	
	540																								
	270																								
	135																								
	810																							P.180	
	540																								
	270																								
	135																							P.181	
	720																							P.182	
	480																								
	240																								
	120																								
	420																							P.184	
	210																								
	105																								
	810																							P.185	
	540																								
	270																								
	135																								
																								P.186	
	810																							P.188	
	540																								
	270																								
	135																								
	810																							P.189	
	540																								
	270																								
	135																								
	1440	1200	960	840	720																			P.191	
	720	600	480																						
	360	300	240																						
		2200	1900	1500	1200	900	800																	P.193	
	1440	1200	960	840	720																			P.195	
	720	600	480																						
	360	300	240																						
			1200																						P.197
	1200																								P.190
	1200																								P.194
	1200																								P.198
	1200																								P.200
	1200																								P.202
	1200																								P.204
	1875																								P.206
	1875																								P.208
	1875																								P.210

- Articulated robots
YA
- Linear conveyor modules
LCM100
- Compact single-axis robots
TRANSEVO
- Single-axis robots
FLIP-X
- Linear motor single-axis robots
PHASER
- Cartesian robots
XY-X
- SCARA robots
YK-X
- Pick & place robots
YP-X
- CLEAN
- CONTROLLER
- INFORMATION
- T type
- F type
- GF type
- N type
- B/R type

Robot ordering method description

In the order format for the YAMAHA single-axis robots FLIP-X series, the notation (letters/numbers) for the mechanical section is shown linked to the controller section notation.

[Example]

● Mechanical ▶ F8

- Lead ▷ 20mm
- Brake ▷ Yes
- Origin position ▷ Non-motor side
- Grease ▷ Standard
- Stroke ▷ 500mm
- Cable length ▷ 3.5m

● Controller ▶ SR1-X

- Usable for CE ▷ Not required
- Regenerative unit ▷ Not required
- I/O selection ▷ NPN
- Battery ▷ With battery

● Ordering method

F8-20-BK-Z-500-3L-SR1-X05-N-B

Mechanical section

Controller section

This page describes using the ordering form for mechanical components.

To find detailed controller information see the controller page.

SR1-X ▶ [P.516](#), TS-X ▶ [P.490](#), RDV-X ▶ [P.504](#)

Mechanical section

● T type / F type (F8 / F8L / F8LH)

① Model	③ Lead designation	④ Brake	⑩ Option	⑪ Stroke	⑫ Cable length
T4L F8 T4LH F8L T5L F8LH T5LH T6 T9 T9H	30 30mm 20 20mm 12 12mm 10 10mm 6 6mm 5 5mm 2 2mm	No entry / No brakes BK / Brakes provided	Origin position change None Z Standard Non-motor side	Grease type None GC Standard Clean	3L 3.5m 5L 5m 10L 10m 3K 3.5m 5K 5m 10K 10m

● F type (Except F8 / F8L / F8LH)

① Model	③ Lead designation	④ Brake	⑥ Cable entry location	⑩ Option	⑪ Stroke	⑫ Cable length
F10 F20 F10H F20N F14 F14H F17 F17L	50 50mm 40 40mm 30 30mm 20 20mm 10 10mm 5 5mm	No entry / No brakes BK / Brakes provided	No entry / Standard (S) U / From the top R / From the right L / From the left	Origin position change None Z Standard Non-motor side	Grease type None GC Standard Clean	3L 3.5m 5L 5m 10L 10m 3K 3.5m 5K 5m 10K 10m

● GF type

① Model	② Model	⑤ Take out direction	③ Lead designation	⑥ Cable entry location	⑩ Option	⑪ Stroke	⑫ Cable length	
GF14XL GF17XL	S / Straight model	H / Horizontal installation	20 20mm	No entry / Standard (S) U / From the top R / From the right L / From the left	Origin position change None Z Standard Non-motor side	Frame No entry (Spot facing) T Tapping	Grease type None GC Standard Clean	3L 3.5m 5L 5m 10L 10m 3K 3.5m 5K 5m 10K 10m

● N type (Single carriage)

① Model	③ Lead designation	⑦ Cable carrier entry location	⑧ Cable carrier specification	⑩ Option	⑪ Stroke	⑫ Cable length
N15 N18	20 20mm	RH / Horizontal, right LH / Horizontal, left RW / Wall, right LW / Wall, left	S / Standard cable carrier M / Optional cable carrier	Origin position change None Z Standard Non-motor side	Grease type None GC Standard Clean	3L 3.5m 5L 5m 10L 10m 3K 3.5m 5K 5m 10K 10m

● N type (Double carriage)

① Model	③ Lead designation	⑤ Take out direction	⑧ Cable carrier specification	⑩ Option	⑪ Stroke	⑫ Cable length
N15D N18D	20 20mm	H / Horizontal installation W / Wall hanging installation	S / Standard cable carrier M / Optional cable carrier	Grease type None GC Standard Clean	3L 3.5m 5L 5m 10L 10m 3K 3.5m 5K 5m 10K 10m	

● B type

① Model	⑨ Motor installation direction	⑩ Option	⑪ Stroke	⑫ Cable length
B10 B14 B14H	L / Motor leftward, horizontal position R / Motor rightward, horizontal position LU / Motor leftward, upper position RU / Motor rightward, upper position LD / Motor leftward, lower position RD / Motor rightward, lower position	Grease type None GC Standard Clean	3L 3.5m 5L 5m 10L 10m 3K 3.5m 5K 5m 10K 10m	

● R type

① Model	⑥ Cable entry location	⑫ Cable length
R5 R10 R20	No entry / Standard (S) B / From the side	3L 3.5m 5L 5m 10L 10m 3K 3.5m 5K 5m 10K 10m

Robot ordering method terminology

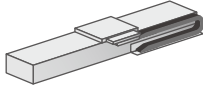
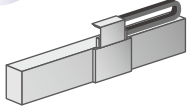
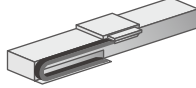
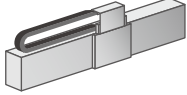
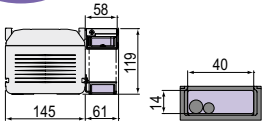
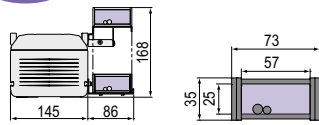
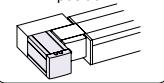
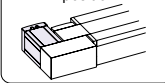
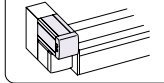
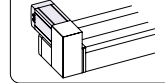
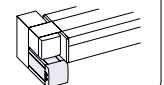
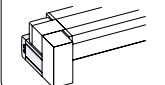
① Model	Enter the robot unit model.
② Model	Straight model only (GF type)
③ Lead designation	Select the ball screw lead.
④ Brake	Select Brake or No-brake. Horizontal specs : No-brake Vertical specs : with Brake
⑤ Take out direction	Select what direction to install the robot (horizontal / wall mounted).
⑥ Cable entry location	Select what direction to extract the robot cable connecting the robot and controller.
⑦ Cable carrier entry location	Select what direction to install the robot (horizontal / wall mounted) and what direction to extract the robot cable carrier. <div style="display: flex; justify-content: space-around; align-items: flex-start;"> <div style="text-align: center;"> <p>RH Horizontal, right</p>  </div> <div style="text-align: center;"> <p>RW Wall, right</p>  </div> <div style="text-align: center;"> <p>LH Horizontal, left</p>  </div> <div style="text-align: center;"> <p>LW Wall, left</p>  </div> </div> <p>Note. Be sure to install in the direction as specified (in cable carrier take-out direction drawing and various specification drawings) individually. Installation in any other way will cause a failure. For requirement of installation in any way other than the above standard installation, please consult YAMAHA as special arrangement will be available.</p>
⑧ Cable carrier specification	Select the cable carrier size for the customer wiring. <div style="display: flex; justify-content: space-around; align-items: flex-start;"> <div style="text-align: center;"> <p>S type Standard cable carrier</p>  </div> <div style="text-align: center;"> <p>M type Optional cable carrier</p>  </div> </div> <p>Note. Cannot pass more than 3 urethane hoses (φ6 x 4). □ Space for optional cable for users </p>
⑨ Motor installation direction	Select what direction to install the motor. <div style="display: grid; grid-template-columns: repeat(2, 1fr); gap: 10px;"> <div style="text-align: center;"> <p>L type Leftward at horizontal position</p>  </div> <div style="text-align: center;"> <p>R type Rightward at horizontal position</p>  </div> <div style="text-align: center;"> <p>LU type Leftward at upper position</p>  </div> <div style="text-align: center;"> <p>RU type Rightward at upper position</p>  </div> <div style="text-align: center;"> <p>LD type Leftward at lower position</p>  </div> <div style="text-align: center;"> <p>RD type Rightward at lower position</p>  </div> </div>
⑩ Option	Origin position change: Origin point position can be changed.
	Frame: Hole to secure the frame can be selected. (Spot facing/tapping)
	Grease type: Clean grease can be selected.
⑪ Stroke	Select the stroke for the robot movement range.
⑫ Cable length	Select the robot cable length to use for connecting the robot to the controller. 1L : 1m (You can select a 1m cable only when you use T4L/T5L.) 3L : 3.5m (Standard) 5L : 5m 10L : 10m 3K : 3.5m (Flexible cable) 5K : 5m (Flexible cable) 10K : 10m (Flexible cable)

YA	Articulated robots
LCM100	Linear conveyor modules
TRANSEVO	Compact single-axis robots
FLIP-X	Single-axis robots
PHASER	Linear motor single-axis robots
XY-X	Cartesian robots
YK-X	SCARA robots
YP-X	Pick & place robots
CLEAN	CLEAN
CONTROLLER INFORMATION	CONTROLLER INFORMATION
T type	T type
F type	F type
GF type	GF type
N type	N type
B/R type	B/R type

T4L

Origin on the non-motor side is selectable

Controller: 24V



Ordering method

T4L							ERC	
Model	Lead designation	Brake	Origin position change	Grease type	Stroke	Cable length ^{Note 1}	Controller	I/O connector specification
	12: 12mm 6: 6mm 2: 2mm	No entry: No brakes BK: Brakes provided	None: Standard Z: Non-motor side	None: Standard GC: Clean	50 to 400 (50mm pitch)	1L: 1m 3L: 3.5m 5L: 5m 10L: 10m 1K/3K/5K/10K (Flexible cable)		CN1: I/O flat cable 1m (Standard) CN2: Twisted-pair cable 2m (pulse train function)

Note 1. The robot cable is standard cable (1L/3L/5L/10L), but can be changed to flexible cable. See P.594 for details on robot cable.

Specifications

AC servo motor output (W)	30
Repeatability ^{Note 1} (mm)	+/-0.02
Deceleration mechanism	Ball screw $\phi 8$ (Class C10)
Ball screw lead (mm)	12 6 2
Maximum speed (mm/sec)	720 360 120
Maximum payload (kg)	Horizontal 4.5 6 6 Vertical 1.2 2.4 7.2
Rated thrust (N)	32 64 153
Stroke (mm)	50 to 400 (50mm pitch)
Overall length (mm)	Horizontal Stroke+198 Vertical Stroke+236
Maximum dimensions of cross section of main unit (mm)	W45 x H53
Cable length (m)	Standard: 3.5 / Option: 1.5, 10
Linear guide type	2 rows of gothic arch grooves x 1 rail
Position detector	Resolvers ^{Note 2}
Resolution (Pulse/rotation)	16384

Note 1. Positioning repeatability in one direction.

Note 2. Position detectors (resolvers) are common to incremental and absolute specifications. If the controller has a backup function then it will be absolute specifications.

Allowable overhang^{Note}

Horizontal installation (Unit: mm)				Wall installation (Unit: mm)				Vertical installation (Unit: mm)				
Lead	Weight	A	B	Lead	Weight	A	B	Lead	Weight	C		
Lead 12	2kg	433	87	180	Lead 12	2kg	149	54	Lead 12	1.2kg	125	125
	4.5kg	223	33	75		4.5kg	50	1		148	Lead 6	2.4kg
Lead 6	3kg	515	58	135	Lead 6	3kg	107	24	Lead 6	3kg		41
	6kg	340	26	62		6kg	31	0		195	Lead 2	7.2kg
Lead 2	3kg	1585	58	142	Lead 2	3kg	113	24	Lead 2	3kg		41
	6kg	755	27	66		6kg	32	0		440	Lead 2	7.2kg

Note. Distance from center of slider top to center of gravity of object being carried at a guide service life of 10,000 km.

Note. Service life is calculated for 300mm stroke models.

Static loading moment

(Unit: N·m)		
MY	MP	MR
15	19	18

Controller

Controller	Operation method
ERC	Pulse train control / Programming / I/O point trace / Remote command / Operation using RS-232C communication

T4L

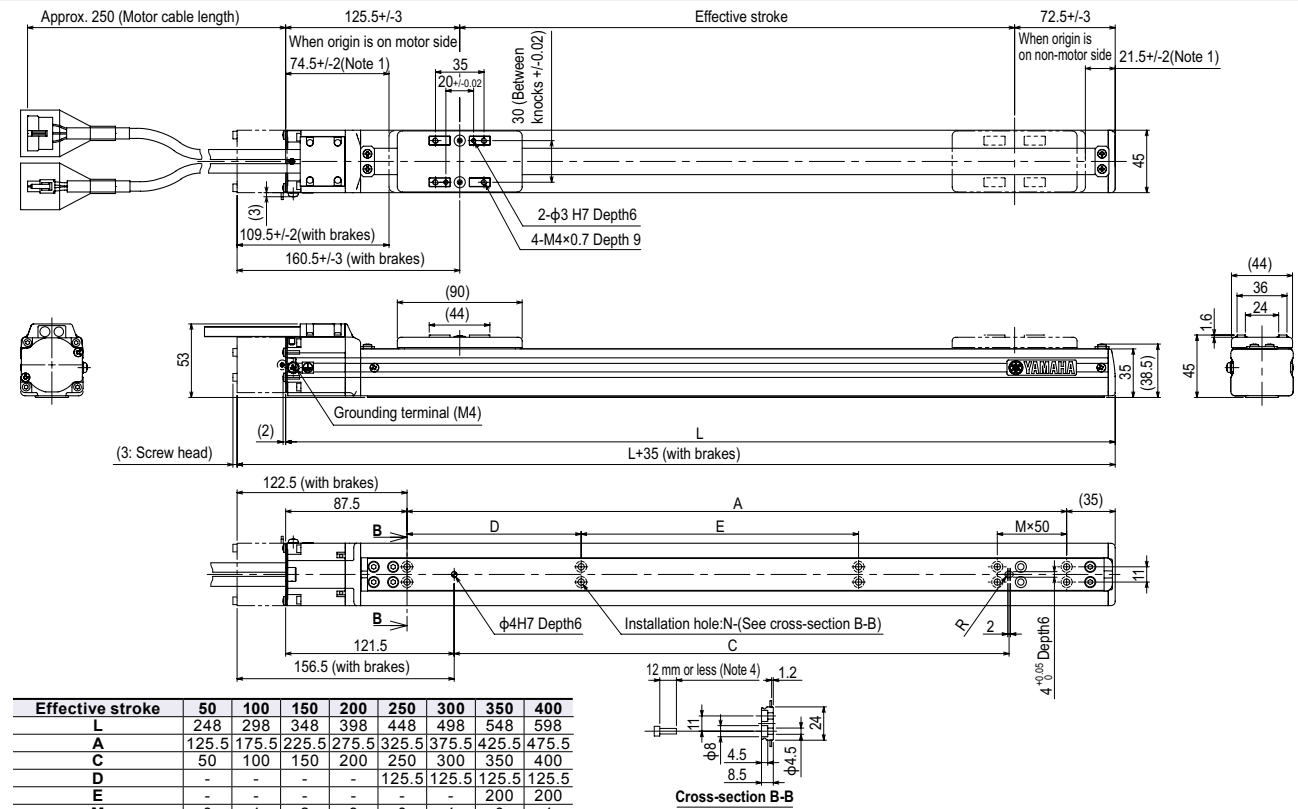

Effective stroke	50	100	150	200	250	300	350	400
L	248	298	348	398	448	498	548	598
A	125.5	175.5	225.5	275.5	325.5	375.5	425.5	475.5
C	50	100	150	200	250	300	350	400
D	-	-	-	-	125.5	125.5	125.5	125.5
E	-	-	-	-	-	200	200	-
M	0	1	2	3	0	1	0	1
N	4	6	8	10	6	8	8	10
Weight (kg) ^{Note 3}	1.1	1.2	1.4	1.5	1.6	1.7	1.8	1.9
Maximum speed for each stroke (mm/sec)	Lead 12	720						
	Lead 6	360						
	Lead 2	120						

Note 1. Stop positions are determined by the mechanical stoppers at both ends.

Note 2. Minimum bend radius of motor cable is R30.

Note 3. Weight of models with no brake. The weight of brake-attached models is 0.2 kg heavier than the models with no brake shown in the table.

Note 4. The under-head length of the hex socket-head bolt (M4x0.7) to be used for the installation work is 12mm or less.

Note 5. External view of T4LH is identical to T4L.

T4LH

Origin on the non-motor side is selectable

Controller: 100V / 200V



Ordering method

T4LH

Model	Lead designation	Brake	Origin position change	Grease type	Stroke	Cable length ^{Note 1}
	12: 12mm 6: 6mm 2: 2mm	No entry: No brakes BK: Brakes provided	None: Standard Z: Non-motor side	None: Standard GC: Clean	50 to 400 (50mm pitch)	3L: 3.5m 5L: 5m 10L: 10m 3K/5K/10K (Flexible cable)

TSX

Positioner ^{Note 2}	Driver: Power-supply voltage / Power capacity	LCD monitor	I/O selection	Battery
TS-X	105: 100V/100W or less 205: 200V/100W or less	No entry: None L: With LCD	NP: NPN PN: PNP CC: CC-Link DN: DeviceNet™ EP: EtherNet/IP™ PT: PROFIBUS GW: No I/O board ^{Note 3}	B: With battery (Absolute) N: None (Incremental)

SR1-X

Controller	Driver: Power capacity	Usable for CE	I/O selection	Battery
05	05: 100W or less	No entry: Standard E: CE marking	N: NPN P: PNP CC: CC-Link DN: DeviceNet™ PB: PROFIBUS	B: With battery (Absolute) N: None (Incremental)

RDV-X

Driver	Power-supply voltage	Driver: Power capacity
2	2: AC200V	05: 100W or less

Note 1. The robot cable is standard cable (3L/5L/10L), but can be changed to flexible cable. See P.594 for details on robot cable.
 Note 2. See P.498 for DIN rail mounting bracket.
 Note 3. Select this selection when using the gateway function. For details, see P.60.

Specifications

AC servo motor output (W)	30
Repeatability ^{Note 1} (mm)	+/- 0.02
Deceleration mechanism	Ball screw $\phi 8$ (Class C10)
Ball screw lead (mm)	12 6 2
Maximum speed (mm/sec)	720 360 120
Maximum payload (kg)	Horizontal: 4.5, 6, 7.2 Vertical: 1.2, 2.4, 7.2
Rated thrust (N)	32 64 153
Stroke (mm)	50 to 400 (50mm pitch)
Overall length (mm)	Horizontal: Stroke+198 Vertical: Stroke+236
Maximum dimensions of cross section of main unit (mm)	W45 x H53
Cable length (m)	Standard: 3.5 / Option: 5, 10
Linear guide type	2 rows of gothic arch grooves x 1 rail
Position detector	Resolvers ^{Note 2}
Resolution (Pulse/rotation)	16384

Note 1. Positioning repeatability in one direction.
 Note 2. Position detectors (resolvers) are common to incremental and absolute specifications. If the controller has a backup function then it will be absolute specifications.

Allowable overhang^{Note}

Installation	Unit: mm	A	B	C
Horizontal installation	(Unit: mm)	A	B	C
Lead 12	2kg	341	90	174
	4.5kg	172	37	72
Lead 6	3kg	355	58	134
	6kg	235	27	62
Lead 2	3kg	1105	59	142
	6kg	520	27	66
Wall installation	(Unit: mm)	A	B	C
Lead 12	2kg	140	73	300
	4.5kg	47	22	119
Lead 6	3kg	105	42	260
	6kg	31	11	135
Lead 2	3kg	113	42	810
	6kg	32	11	305
Vertical installation	(Unit: mm)	A	C	
Lead 12	1.2kg	122	121	
Lead 6	2.4kg	56	57	
Lead 2	3kg	41	42	
	7.2kg	0	0	

Note. Distance from center of slider top to center of gravity of object being carried at a guide service life of 10,000 km.
 Note. Service life is calculated for 300mm stroke models.

Static loading moment

Direction	Unit: N-m
MY	15
MP	19
MR	18

Controller

Controller	Operation method
SR1-X05	Programming / I/O point trace / Remote command / Operation using RS-232C communication
RCX221/222	
RCX240/340	
TS-X105	I/O point trace / Remote command
TS-X205	
RDV-X205	Pulse train control

T4LH

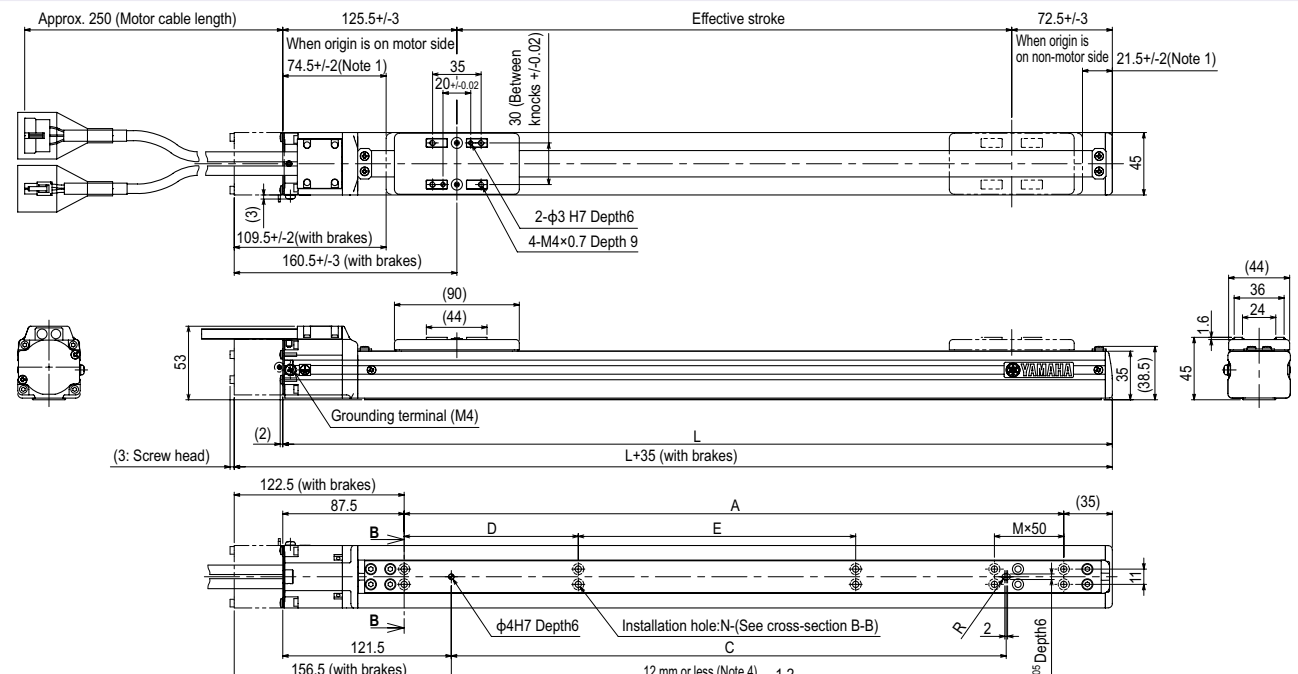

Effective stroke	50	100	150	200	250	300	350	400
L	248	298	348	398	448	498	548	598
A	125.5	175.5	225.5	275.5	325.5	375.5	425.5	475.5
C	50	100	150	200	250	300	350	400
D	-	-	-	-	125.5	125.5	125.5	125.5
E	-	-	-	-	-	200	200	200
M	0	1	2	3	0	1	0	1
N	4	6	8	10	6	8	8	10
Weight (kg) ^{Note 3}	1.1	1.2	1.4	1.5	1.6	1.7	1.8	1.9
Maximum speed for each stroke (mm/sec)								
Lead 12	720							
Lead 6	360							
Lead 2	120							

Note 1. Stop positions are determined by the mechanical stoppers at both ends.
 Note 2. Minimum bend radius of motor cable is R30.
 Note 3. Weight of models with no brake. The weight of brake-attached models is 0.2 kg heavier than the models with no brake shown in the table.
 Note 4. The under-head length of the hex socket-head bolt (M4x0.7) to be used for the installation work is 12mm or less.
 Note 5. External view of T4LH is identical to T4L.

T5L

- High lead: Lead 20
- Origin on the non-motor side is selectable
- Controller: 24V



Ordering method

T5L							ERCD	
Model	Lead designation	Brake ^{Note 1}	Origin position change	Grease type	Stroke	Cable length ^{Note 2}	Controller	I/O connector specification
	20: 20mm 12: 12mm 6: 6mm	No entry: No brakes BK: Brakes provided	None: Standard Z: Non-motor side	None: Standard GC: Clean	50 to 800 (50mm pitch)	1L: 1m 3L: 3.5m 5L: 5m 10L: 10m 1K/3K/5K/10K (Flexible cable)		CN1: I/O flat cable 1m (Standard) CN2: Twisted-pair cable 2m (pulse train function)

Note 1. The model with a lead of 20mm cannot select specifications with brake (vertical specifications).
 Note 2. The robot cable is standard cable (1L/3L/5L/10L), but can be changed to flexible cable. See P.594 for details on robot cable.

Specifications

AC servo motor output (W)	30
Repeatability ^{Note 1} (mm)	+/-0.02
Deceleration mechanism	Ball screw $\phi 12$ (Class C10)
Ball screw lead (mm)	20 12 6
Maximum speed ^{Note 2} (mm/sec)	1200 800 400
Maximum payload (kg)	Horizontal 3 5 9 Vertical - 1.2 2.4
Rated thrust (N)	19 32 64
Stroke (mm)	50 to 800 (50mm pitch)
Overall length (mm)	Horizontal Stroke+201.5 Vertical Stroke+239.5
Maximum dimensions of cross section of main unit (mm)	W55×H52
Cable length (m)	Standard: 3.5 / Option: 1.5, 10
Linear guide type	2 rows of gothic arch grooves × 1 rail
Position detector	Resolvers ^{Note 3}
Resolution (Pulse/rotation)	16384

Note 1. Positioning repeatability in one direction.
 Note 2. When the stroke is longer than 600mm, resonance of the ball screw may occur depending on the operation conditions (critical speed). In this case, reduce the speed setting on the program by referring to the maximum speeds shown in the table below.
 Note 3. Position detectors (resolvers) are common to incremental and absolute specifications. If the controller has a backup function then it will be absolute specifications.

Allowable overhang^{Note}

	Horizontal installation (Unit: mm)			Wall installation (Unit: mm)			Vertical installation (Unit: mm)		
	A	B	C	A	B	C	A	C	
Lead 20	1kg 600	323	683	1kg 600	291	600	1.2kg 242	240	
Lead 12	3kg 675	103	247	3kg 215	73	589	2.4kg 113	113	
Lead 6	2kg 1170	159	406	2kg 368	127	1082			
	5kg 555	59	155	5kg 127	30	449			
	3kg 1498	104	294	3kg 263	73	970			
	9kg 628	31	89	9kg 54	0	400			

Note. Distance from center of slider top to center of gravity of object being carried at a guide service life of 10,000 km.
 Note. Service life is calculated for 600mm stroke models.

Static loading moment

(Unit: N·m)		
MY	MP	MR
30	34	40

Controller

Controller	Operation method
ERCD	Pulse train control / Programming / I/O point trace / Remote command / Operation using RS-232C communication

T5L

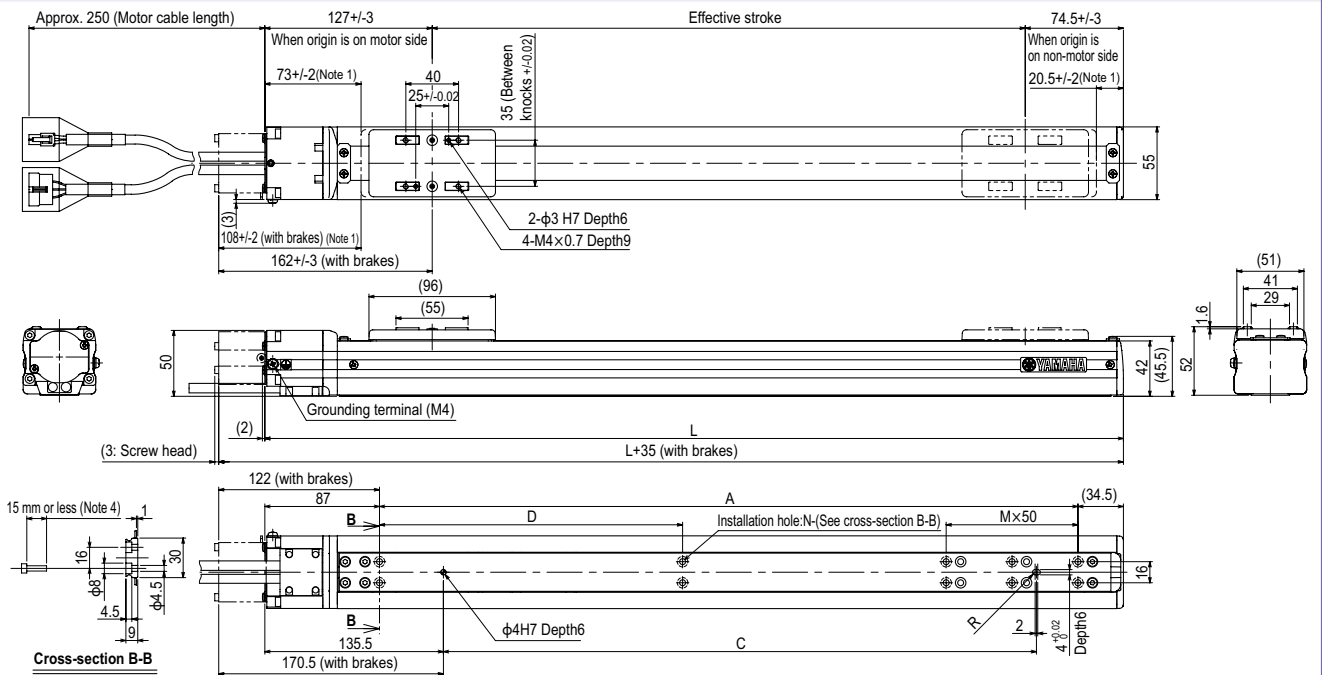

Effective stroke	50	100	150	200	250	300	350	400	450	500	550	600	650	700	750	800
L	251.5	301.5	351.5	401.5	451.5	501.5	551.5	601.5	651.5	701.5	751.5	801.5	851.5	901.5	951.5	1001.5
A	130	180	230	280	330	380	430	480	530	580	630	680	730	780	830	880
C	50	100	150	200	250	300	350	400	450	500	550	600	650	700	750	800
D	-	-	-	-	-	230	230	230	230	230	230	230	230	230	230	230
M	0	1	2	3	4	5	0	1	2	3	4	5	6	7	8	9
N	4	6	8	10	12	14	6	8	10	12	14	16	18	20	22	24
Weight (kg) ^{Note 3}	1.7	1.8	2.0	2.2	2.3	2.5	2.7	2.8	3.0	3.2	3.3	3.5	3.7	3.8	4.0	4.2
Maximum speed for each stroke ^{Note 5} (mm/sec)																
Lead 20												960	840	720	660	
Lead 12												640	560	480	440	
Lead 6												320	280	240	220	
Speed setting												80%	70%	60%	55%	

Note 1. Stop positions are determined by the mechanical stoppers at both ends.
 Note 2. Minimum bend radius of motor cable is R30.
 Note 3. Weight of models with no brake. The weight of brake-attached models is 0.2 kg heavier than the models with no brake shown in the table.
 Note 4. The under-head length of the hex socket-head bolt (M4x0.7) to be used for the installation work is 15mm or less.
 Note 5. When the stroke is longer than 600mm, resonance of the ball screw may occur depending on the operation conditions (critical speed). In this case, reduce the speed setting on the program by referring to the maximum speeds shown in the table at the left.
 Note 6. External view of T5LH is identical to T5L.

T5LH

- High lead: Lead 20
- Origin on the non-motor side is selectable
- Controller: 100V / 200V



Ordering method

T5LH	Model	Lead designation 20: 20mm 12: 12mm 6: 6mm	Brake ^{Note 1} No entry: No brakes BK: Brakes provided	Origin position change None: Standard Z: Non-motor side	Grease type None: Standard GC: Clean	Stroke 50 to 800 (50mm pitch)	Cable length ^{Note 2} 3L: 3.5m 5L: 5m 10L: 10m 3K/5K/10K (Flexible cable)	TSX	Positioner ^{Note 3} TS-X	Driver: Power-supply voltage / Power capacity 105: 100V/100W or less 205: 200V/100W or less	LCD monitor No entry: None L: With LCD	I/O selection NP: NPN PN: PNP CC: CC-Link DN: DeviceNet™ EP: EtherNet/IP™ PT: PROFINET GW: No I/O board ^{Note 4}	Battery B: With battery (Absolute) N: None (Incremental)	
								SR1-X	Controller	05	Driver: Power capacity 05: 100W or less	Usable for CE No entry: Standard E: CE marking	I/O selection N: NPN P: PNP CC: CC-Link DN: DeviceNet™ PB: PROFIBUS	Battery B: With battery (Absolute) N: None (Incremental)
								RDV-X	Driver	2	Power-supply voltage 2: AC200V		05	Driver: Power capacity 05: 100W or less

- Note 1. The model with a lead of 20mm cannot select specifications with brake (vertical specifications).
 Note 2. The robot cable is standard cable (3L/5L/10L), but can be changed to flexible cable. See P.594 for details on robot cable.
 Note 3. See P.498 for DIN rail mounting bracket.
 Note 4. Select this selection when using the gateway function. For details, see P.60

Specifications

AC servo motor output (W)	30
Repeatability ^{Note 1} (mm)	+/-0.02
Deceleration mechanism	Ball screw ϕ 12 (Class C10)
Ball screw lead (mm)	20 12 6
Maximum speed ^{Note 2} (mm/sec)	1200 800 400
Maximum payload (kg)	Horizontal 3 5 9 Vertical - 1.2 2.4
Rated thrust (N)	19 32 64
Stroke (mm)	50 to 800 (50mm pitch)
Overall length (mm)	Horizontal Stroke+201.5 Vertical Stroke+239.5
Maximum dimensions of cross section of main unit (mm)	W55×H52
Cable length (m)	Standard: 3.5 / Option: 5,10
Linear guide type	2 rows of gothic arch grooves × 1 rail
Position detector	Resolvers ^{Note 3}
Resolution (Pulse/rotation)	16384

- Note 1. Positioning repeatability in one direction.
 Note 2. When the stroke is longer than 600mm, resonance of the ball screw may occur depending on the operation conditions (critical speed). In this case, reduce the speed setting on the program by referring to the maximum speeds shown in the table below.
 Note 3. Position detectors (resolvers) are common to incremental and absolute specifications. If the controller has a backup function then it will be absolute specifications.

Allowable overhang

	Horizontal installation (Unit: mm)				Wall installation (Unit: mm)				Vertical installation (Unit: mm)		
	A	B	C	Stroke	A	B	C	Stroke	Lead	A	C
Lead 20	967	324	598	500	551	304	925	600	1.2kg	240	239
Lead 12	429	104	226	400	185	89	378	400	2.4kg	109	110
Lead 6	916	159	398	300	347	141	800	200			
	436	60	152	200	119	44	355	100			
	1194	105	294	100	3kg	259	87	950			
	624	31	89	50	9kg	50	15	385			

Note. Distance from center of slider top to center of gravity of object being carried at a guide service life of 10,000 km.
 Note. Service life is calculated for 600mm stroke models.

Static loading moment

(Unit: N·m)		
MY	MP	MR
30	34	40

Controller

Controller	Operation method
SR1-X05	Programming / I/O point trace / Remote command / Operation using RS-232C communication
RCX221/222	
RCX240/340	
TS-X105	I/O point trace / Remote command
TS-X205	
RDV-X205	Pulse train control

T5LH

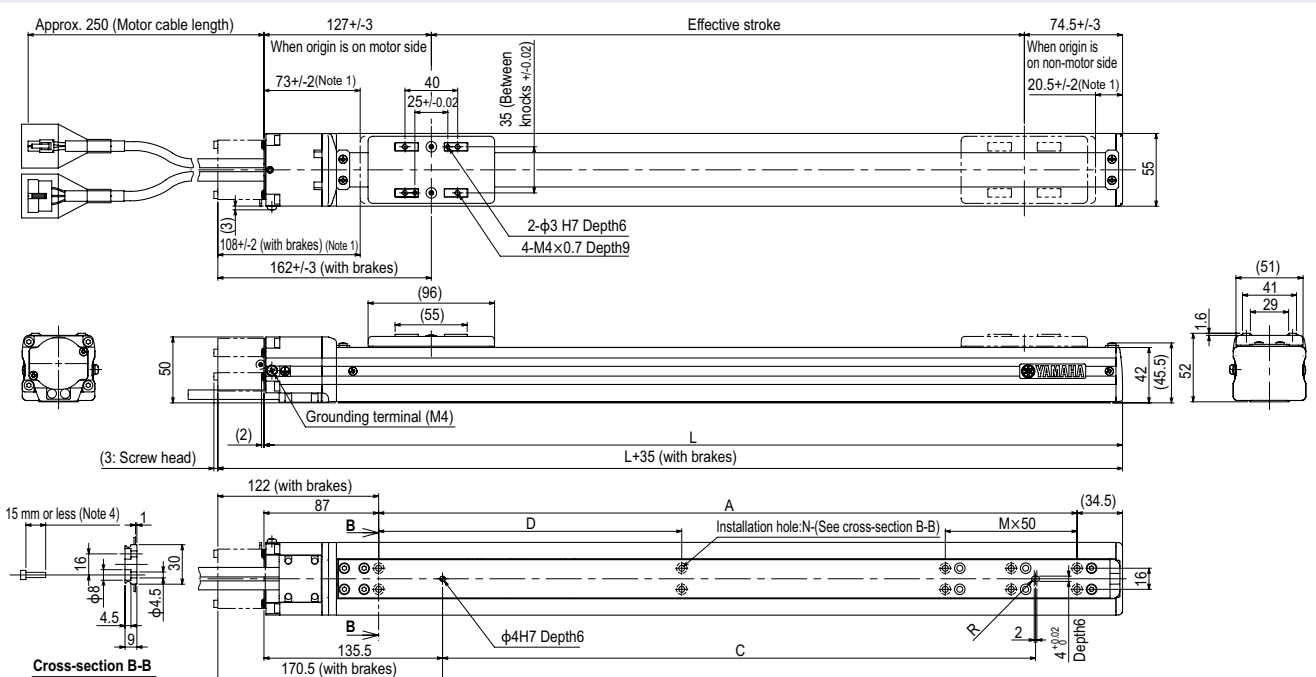

Effective stroke	50	100	150	200	250	300	350	400	450	500	550	600	650	700	750	800
L	251.5	301.5	351.5	401.5	451.5	501.5	551.5	601.5	651.5	701.5	751.5	801.5	851.5	901.5	951.5	1001.5
A	130	180	230	280	330	380	430	480	530	580	630	680	730	780	830	880
C	50	100	150	200	250	300	350	400	450	500	550	600	650	700	750	800
D	-	-	-	-	-	230	230	230	230	230	230	230	230	230	230	230
M	0	1	2	3	4	5	0	1	2	3	4	5	6	7	8	9
N	4	6	8	10	12	14	6	8	10	12	14	16	18	20	22	24
Weight (kg) ^{Note 3}	1.7	1.8	2.0	2.2	2.3	2.5	2.7	2.8	3.0	3.2	3.3	3.5	3.7	3.8	4.0	4.2
Maximum speed for each stroke ^{Note 5} (mm/sec)	-															
Speed setting	-															

- Note 1. Stop positions are determined by the mechanical stoppers at both ends.
 Note 2. Minimum bend radius of motor cable is R30.
 Note 3. Weight of models with no brake. The weight of brake-attached models is 0.2 kg heavier than the models with no brake shown in the table.
 Note 4. The under-head length of the hex socket-head bolt (M4×0.7) to be used for the installation work is 15mm or less.
 Note 5. When the stroke is longer than 600mm, resonance of the ball screw may occur depending on the operation conditions (critical speed). In this case, reduce the speed setting on the program by referring to the maximum speeds shown in the table at the left.
 Note 6. External view of T5LH is identical to T5L.

T6L

- High lead: Lead 20
- Origin on the non-motor side is selectable
- Controller: 100V / 200V



Ordering method

T6L	Model	Lead designation 20: 20mm 12: 12mm 6: 6mm	Brake ^{Note 1} No entry: No brakes BK: Brakes provided	Origin position change None: Standard Z: Non-motor side	Grease type None: Standard GC: Clean	Stroke 50 to 800 (50mm pitch)	Cable length ^{Note 3} 3L: 3.5m 5L: 5m 10L: 10m 5K/5K/10K (Flexible cable)	TSX	Positioner ^{Note 3} TS-X	Driver: Power-supply voltage / Power capacity 105: 100V/100W or less 205: 200V/100W or less	LCD monitor No entry: None L: With LCD	I/O selection NP: NPN PN: PNP CC: CC-Link DN: DeviceNet™ EP: EtherNet/IP™ PT: PROFINET GW: No I/O board ^{Note 4}	Battery B: With battery (Absolute) N: None (Incremental)			
								SR1-X	Controller	05	Driver: Power capacity 05: 100W or less	Usable for CE No entry: Standard E: CE marking	I/O selection N: NPN P: PNP CC: CC-Link DN: DeviceNet™ PB: PROFIBUS	Battery B: With battery (Absolute) N: None (Incremental)		
								RDV-X	Driver	2	Power-supply voltage 2: AC200V		05	Driver: Power capacity 05: 100W or less	RBR1	Regenerative unit

Note 1. The model with a lead of 20mm cannot select specifications with brake (vertical specifications).
 Note 2. The robot cable is standard cable (3L/5L/10L), but can be changed to flexible cable. See P.594 for details on robot cable.
 Note 3. See P.498 for DIN rail mounting bracket.
 Note 4. Select this selection when using the gateway function. For details, see P.60.

Specifications

AC servo motor output (W)	60
Repeatability ^{Note 1} (mm)	+/-0.02
Deceleration mechanism	Ball screw $\phi 12$ (Class C10)
Ball screw lead (mm)	20 12 6
Maximum speed ^{Note 2} (mm/sec)	1333 800 400
Maximum payload (kg)	Horizontal 10 12 30 Vertical - 4 8
Rated thrust (N)	51 85 170
Stroke (mm)	50 to 800 (50mm pitch)
Overall length (mm)	Horizontal Stroke+247.5 Vertical Stroke+285.5
Maximum dimensions of cross section of main unit (mm)	W65×H56
Cable length (m)	Standard: 3.5 / Option: 5,10
Linear guide type	2 rows of gothic arch grooves × 1 rail
Position detector	Resolvers ^{Note 3}
Resolution (Pulse/rotation)	16384

Note 1. Positioning repeatability in one direction.
 Note 2. When the stroke is longer than 600mm, resonance of the ball screw may occur depending on the operation conditions (critical speed). In this case, reduce the speed setting on the program by referring to the maximum speeds shown in the table below.
 Note 3. Position detectors (resolvers) are common to incremental and absolute specifications. If the controller has a backup function then it will be absolute specifications.

Allowable overhang

Installation	Lead	Horizontal installation (Unit: mm)			Wall installation (Unit: mm)			Vertical installation (Unit: mm)				
		A	B	C	A	B	C	A	B	C		
Horizontal	20	2kg	319	184	234	2kg	234	152	265	1kg	355	352
	6	6kg	98	37	77	6kg	61	13	71	2kg	165	165
		10kg	64	0	55	10kg	30	0	42	4kg	70	72
Wall	20	3kg	624	125	335	3kg	293	96	510	2kg	171	172
	6	8kg	273	41	121	8kg	89	14	210	4kg	73	74
		12kg	216	24	77	12kg	43	0	130	8kg	23	26
Vertical	20	5kg	694	73	236	5kg	204	45	530			
	6	10kg	374	33	109	10kg	72	0	245			
		30kg	159	0	25	30kg	0	0	0			

Note. Distance from center of slider top to center of gravity of object being carried at a guide service life of 10,000 km.
 Note. Service life is calculated for 600mm stroke models.

Static loading moment

Direction	Value (Unit: N·m)
MY	35
MP	40
MR	50

Controller

Controller	Operation method
SR1-X05	Programming / I/O point trace / Remote command / Operation using RS-232C communication
RCX221/222	
RCX240/340	
TS-X105	I/O point trace / Remote command
TS-X205	
RDV-X205-RBR1	Pulse train control

T6L

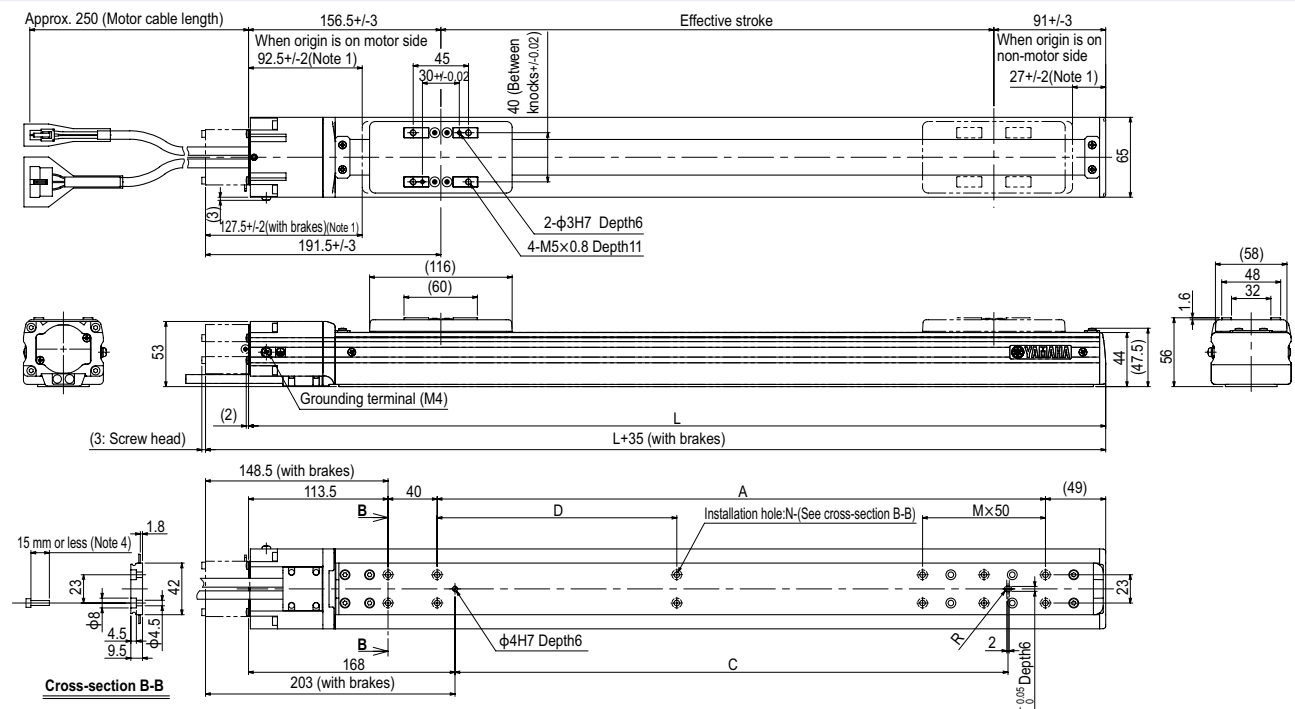

Effective stroke	Stroke (mm)															
	50	100	150	200	250	300	350	400	450	500	550	600	650	700	750	800
L	297.5	347.5	397.5	447.5	497.5	547.5	597.5	647.5	697.5	747.5	797.5	847.5	897.5	947.5	997.5	1047.5
A	95	145	195	245	295	345	395	445	495	545	595	645	695	745	795	845
C	50	100	150	200	250	300	350	400	450	500	550	600	650	700	750	800
D	-	-	-	-	-	-	195	195	195	195	195	195	195	195	195	195
M	0	1	2	3	4	5	0	1	2	3	4	5	6	7	8	9
N	6	8	10	12	14	16	8	10	12	14	16	18	20	22	24	26
Weight (kg) ^{Note 3}	2.4	2.6	2.8	3.1	3.3	3.5	3.7	4.0	4.2	4.4	4.6	4.8	5.1	5.3	5.5	5.7
Maximum speed for each stroke ^{Note 5} (mm/sec)	Lead 20	1333														
	Lead 12	800														
	Lead 6	400														
	Speed setting	-														
Speed setting (%)	Lead 20	1133														
	Lead 12	680														
	Lead 6	340														
	Speed setting	85% 75% 65% 60%														

Note 1. Stop positions are determined by the mechanical stoppers at both ends.
 Note 2. Minimum bend radius of motor cable is R30.
 Note 3. Weight of models with no brake. The weight of brake-attached models is 0.2 kg heavier than the models with no brake shown in the table.
 Note 4. The under-head length of the hex socket-head bolt (M4x0.7) to be used for the installation work is 15mm or less.
 Note 5. When the stroke is longer than 600mm, resonance of the ball screw may occur depending on the operation conditions (critical speed). In this case, reduce the speed setting on the program by referring to the maximum speeds shown in the table at the left.

T9

● High lead: Lead 30

● Origin on the non-motor side is selectable: Lead 10-20-30

Note. Strokes longer than 1050mm are special order items. Please consult us for delivery time.



Articulated robots
YA
Linear conveyor modules
LCM100
Compact single-axis robots
TRANSEVO
Single-axis robots
FLIP-X
Linear motor single-axis robots
PHASER
Cartesian robots
XY-X
SCARA robots
YK-X
Pick & place robots
YP-X
CLEAN
CONTROLLER INFORMATION
T type
F type
GF type
N type
BR type

Ordering method

T9						TSX					
Model	Lead designation	Brake ^{Note 1}	Origin position change	Grease type	Stroke	Positioner ^{Note 4}	Driver: Power-supply voltage	Regenerative unit	LCD monitor	I/O selection	Battery
	30: 30mm 20: 20mm 10: 10mm 5: 5mm	No entry/No brakes BK: Brakes provided	None: Standard Z: Non-motor side ^{Note 2}	None: Standard GC: Clean	Lead 20-10-5: 150 to 1050 (50mm pitch) Lead 30: 150 to 1250 (50mm pitch)	TS-X	105: 100V/100W or less 205: 200V/100W or less	No entry: None R: With RGT	No entry: None L: With LCD	NP: NPN PN: PNP CC: CC-Link DN: DeviceNet™ EP: EtherNet/IP™ PT: PROFINET GW: No I/O board ^{Note 5}	B: With battery (Absolute) N: None (Incremental)
						SR1-X	05	Usable for CE	Regenerative unit	I/O selection	Battery
						Controller	Driver: Power capacity 05: 100W or less	No entry: Standard E: CE marking	No entry: None R: With RG1	N: NPN P: PNP CC: CC-Link DN: DeviceNet™ PB: PROFIBUS	B: With battery (Absolute) N: None (Incremental)
						RDV-X	2	05	RBR1		
						Driver	Power-supply voltage 2: AC200V	Driver: Power capacity 05: 100W or less	Regenerative unit		

- Note 1. The model with a lead of 30mm cannot select specifications with brake (vertical specifications).
 Note 2. If selecting 5mm lead specifications then the origin point cannot be changed to the non-motor side.
 Note 3. The robot cable is standard cable (3L/5L/10L), but can be changed to flexible cable. See P.594 for details on robot cable.
 Note 4. See P.498 for DIN rail mounting bracket.
 Note 5. Select this selection when using the gateway function. For details, see P.60.

Specifications

AC servo motor output (W)	100
Repeatability ^{Note 1} (mm)	+/-0.01
Deceleration mechanism	Ball screw (Class C7)
Ball screw lead (mm)	30 20 10 5
Maximum speed ^{Note 2} (mm/sec)	1800 1200 600 300
Maximum payload (kg)	Horizontal 15 30 55 80 Vertical - 4 10 20
Rated thrust (N)	56 84 169 339
Stroke (mm)	150 to 1250 ^{Note 3} (50mm pitch)
Overall length (mm)	Horizontal Stroke+259 Vertical Stroke+289
Maximum dimensions of cross section of main unit (mm)	W94 x H98
Cable length (m)	Standard: 3.5 / Option: 5.10
Linear guide type	4 rows of circular arc grooves x 1 rail
Position detector	Resolvers ^{Note 4}
Resolution (Pulse/rotation)	16384

- Note 1. Positioning repeatability in one direction.
 Note 2. When the stroke is longer than 700mm, resonance of the ball screw may occur depending on the operation conditions (critical speed). In this case, reduce the speed setting on the program by referring to the maximum speeds shown in the table below.
 Note 3. Strokes longer than 1050mm are available only for high lead (Lead 30). (Special order item)
 Note 4. Position detectors (resolvers) are common to incremental and absolute specifications. If the controller has a backup function then it will be absolute specifications.

Allowable overhang

Horizontal installation (Unit: mm)				Wall installation (Unit: mm)				Vertical installation (Unit: mm)				
	A	B	C		A	B	C		A	B	C	
Lead 30	5kg	864	501	383	5kg	348	384	776	Lead 20	1kg	600	600
	15kg	491	156	140	15kg	87	40	306		2kg	1098	1098
	5kg	1292	505	462	5kg	416	388	1186		4kg	545	545
Lead 20	15kg	572	158	151	15kg	92	42	386	Lead 10	4kg	594	594
	30kg	455	73	75	30kg	0	0	61		8kg	280	280
	20kg	617	119	127	10kg	193	132	910		10kg	217	217
Lead 10	40kg	422	53	59	20kg	53	0	400	Lead 5	10kg	221	221
	55kg	420	36	40	30kg	0	0	109		15kg	135	135
	50kg	722	42	47	10kg	197	133	2360		20kg	92	92
Lead 5	60kg	657	33	37	20kg	54	0	985				
	80kg	577	23	25	30kg	0	0	427				

Note. Distance from center of slider top to center of gravity of object being carried at a guide service life of 10,000 km.

Static loading moment

	MY	MP	MR
(Unit: N-m)	86	133	117

Controller

Controller	Operation method
SR1-X05 ^{Note} RCX221/222 RCX240/340	Programming / I/O point trace / Remote command / Operation using RS-232C communication
TS-X105 ^{Note} TS-X205 ^{Note} RDV-X205-RBR1	I/O point trace / Remote command / Pulse train control

Note. Regenerative unit is required when the models used vertically with 700mm or larger stroke.

T9

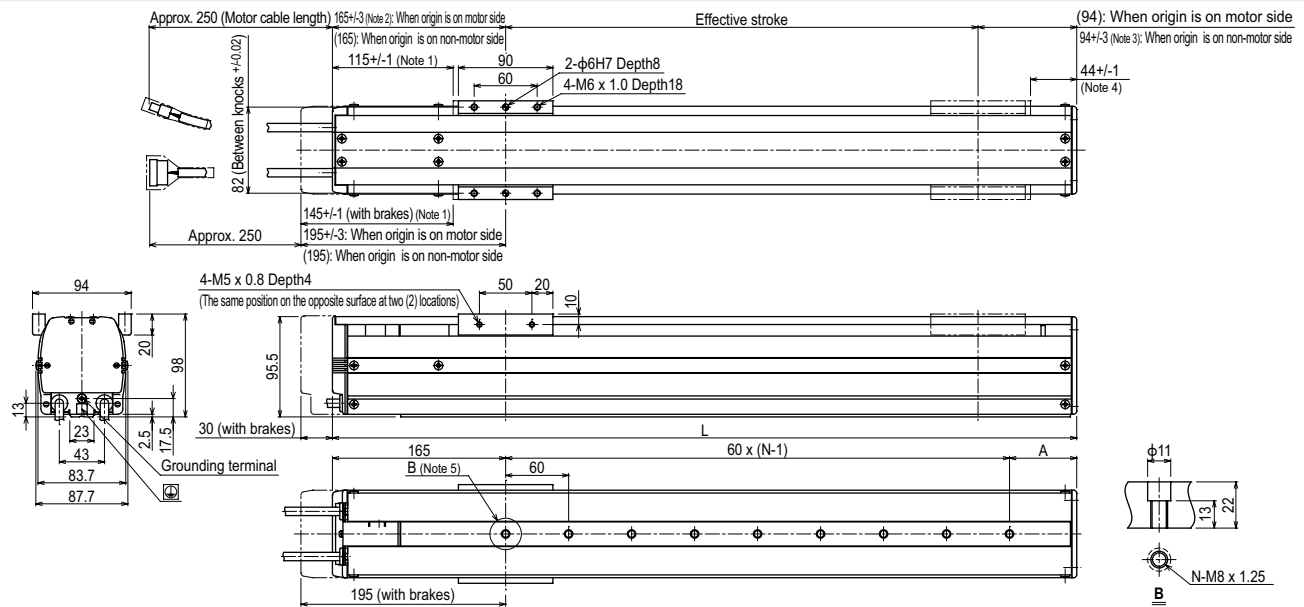

- Note 1. Stop positions are determined by the mechanical stoppers at both ends.
 Note 2. 167.5±1 when the high lead specification (Lead 30) is used.
 Note 3. 94±1 when the high lead specification (Lead 30) is used.
 Note 4. 41.5±1 when the high lead specification (Lead 30) is used.
 Note 5. When installing the unit, washers, etc., cannot be used in the φ11 counter bore hole.
 Note 6. Minimum bend radius of motor cable is R5.
 Note 7. Weight of models with no brake. The weight of brake-attached models is 0.5 kg heavier than the models with no brake shown in the table.

Effective stroke	150	200	250	300	350	400	450	500	550	600	650	700	750	800	850	900	950	1000	1050	1100	1150	1200	1250
L	409	459	509	559	609	659	709	759	809	859	909	959	1009	1059	1109	1159	1209	1259	1309	1359	1409	1459	1509
A	64	54	44	94	84	74	64	54	44	94	84	74	64	54	44	94	84	74	64	54	44	94	84
N	4	5	6	6	7	8	9	10	11	11	12	13	14	15	16	16	17	18	19	20	21	21	22
Weight (kg) ^{Note 7}	5.5	5.9	6.2	6.6	6.9	7.3	7.6	8.0	8.3	8.7	9.0	9.4	9.7	10.0	10.3	10.7	11.0	11.4	11.7	12.1	12.5	12.9	13.3
Maximum speed ^{Note 8} (mm/sec)	Lead 30	1800																					
	Lead 20	1200																					
	Lead 10	600																					
	Lead 5	300																					
Speed setting	-																						
Speed setting																							

- Note 8. When the stroke is longer than 700mm, resonance of the ball screw may occur depending on the operation conditions (critical speed). In this case, reduce the speed setting on the program by referring to the maximum speeds shown in the table above.
 Note 9. Strokes longer than 1050mm are special order items. Please contact us for speed setting.

Controller

SR1-X ▶ 516 TS-X ▶ 490 RDV-X ▶ 504

T9H

● High lead: Lead 30

● Origin on the non-motor side is selectable: Lead 20-30

Note. Strokes longer than 1050mm are special order items. Please consult us for delivery time.



Ordering method

T9H	Model	Lead designation 30: 30mm 20: 20mm 10: 10mm 5: 5mm	Brake ^{Note 1} No entry: No brakes BK: Brakes provided	Origin position change None: Standard 2: Non-motor side ^{Note 2}	Grease type None: Standard GC: Clean	Stroke Lead 20/10/5: 150 to 1050 (50mm pitch) Lead 30: 150 to 1250 (50mm pitch)	Cable length ^{Note 3} 3L: 3.5m 5L: 5m 10L: 10m 3K/5K/10K (Flexible cable)
------------	--------------	---	--	--	---	--	--

TSX	Positioner ^{Note 4} TS-X	Driver: Power-supply voltage Power capacity 110: 100V/200W 210: 200V/200W	Regenerative unit No entry: None R: With RGT	LCD monitor No entry: None L: With LCD	I/O selection NP: NPN PN: PNP CC: CC-Link DN: DeviceNet™ EP: EtherNet/IP™ PT: PROFINET GW: No I/O board ^{Note 5}	Battery B: With battery (Absolute) N: None (Incremental)
------------	---	---	---	---	---	---

- Note 1. The model with a lead of 30mm cannot select specifications with brake (vertical specifications).
 Note 2. If selecting 10mm-5mm lead specifications then the origin point cannot be changed to the non-motor side.
 Note 3. The robot cable is standard cable (3L/5L/10L), but can be changed to flexible cable. See P.594 for details on robot cable.
 Note 4. See P.498 for DIN rail mounting bracket.
 Note 5. Select this selection when using the gateway function. For details, see P.60.

SR1-X	Controller	10	Driver: Power capacity 10: 200W	Usable for CE No entry: Standard E: CE marking	Regenerative unit No entry: None R: With RGT	I/O selection N: NPN P: PNP CC: CC-Link DN: DeviceNet™ PB: PROFIBUS	Battery B: With battery (Absolute) N: None (Incremental)
RDV-X	Driver	2	Power-supply voltage 2: AC200V		10	Driver: Power capacity 10: 200W or less	RBR1

Specifications

AC servo motor output (W)	200
Repeatability ^{Note 1} (mm)	+/-0.01
Deceleration mechanism	Ball screw (Class C7)
Ball screw lead (mm)	30 20 10 5
Maximum speed ^{Note 2} (mm/sec)	1800 1200 600 300
Maximum payload (kg)	Horizontal 25 40 80 100 Vertical - 8 20 30
Rated thrust (N)	113 170 341 683
Stroke (mm)	150 to 1250 ^{Note 3} (50mm pitch)
Overall length (mm)	Horizontal Stroke+273 Vertical Stroke+303
Maximum dimensions of cross section of main unit (mm)	W94 × H98
Cable length (m)	Standard: 3.5 / Option: 5.10
Linear guide type	4 rows of circular arc grooves × 1 rail
Position detector	Resolvers ^{Note 4}
Resolution (Pulse/rotation)	16384

- Note 1. Positioning repeatability in one direction.
 Note 2. When the stroke is longer than 700mm, resonance of the ball screw may occur depending on the operation conditions (critical speed). In this case, reduce the speed setting on the program by referring to the maximum speeds shown in the table below.
 Note 3. Strokes longer than 1050mm are available only for high lead (Lead 30). (Special order item)
 Note 4. Position detectors (resolvers) are common to incremental and absolute specifications. If the controller has a backup function then it will be absolute specifications.

Allowable overhang

Lead	Horizontal installation (Unit: mm)			Wall installation (Unit: mm)			Vertical installation (Unit: mm)		
	A	B	C	A	B	C	A	B	C
Lead 30	10kg 415	286	183	10kg 140	120	323	4kg 515	515	515
Lead 20	10kg 270	105	93	10kg 41	0	123	6kg 334	334	334
Lead 10	10kg 667	244	225	10kg 170	128	549	8kg 244	244	244
Lead 5	10kg 330	112	107	10kg 46	0	182	10kg 217	217	217
Lead 30	40kg 162	42	47	40kg 0	0	0	15kg 133	133	133
Lead 20	40kg 392	75	81	20kg 52	0	335	20kg 90	90	90
Lead 10	40kg 297	40	44	25kg 24	0	235	15kg 135	135	135
Lead 5	80kg 265	21	24	30kg 0	0	108	20kg 92	92	92
Lead 30	60kg 477	22	37	20kg 54	0	710	20kg 92	92	92
Lead 20	80kg 412	22	25	25kg 25	0	505	30kg 49	49	49
Lead 10	100kg 362	16	18	30kg 0	0	355			

Note. Distance from center of slider top to center of gravity of object being carried at a guide service life of 10,000 km.

Static loading moment

(Unit: N·m)		
MY	MP	MR
86	133	117

Controller

Controller	Operation method
SR1-X10 ^{Note} RCX221/222 RCX240/340	Programming / I/O point trace / Remote command / Operation using RS-232C communication
TS-X110 ^{Note} TS-X210 ^{Note} RDV-X210-RBR1	I/O point trace / Remote command / Pulse train control

Note. When using the unit vertically, a regeneration unit is required.

T9H

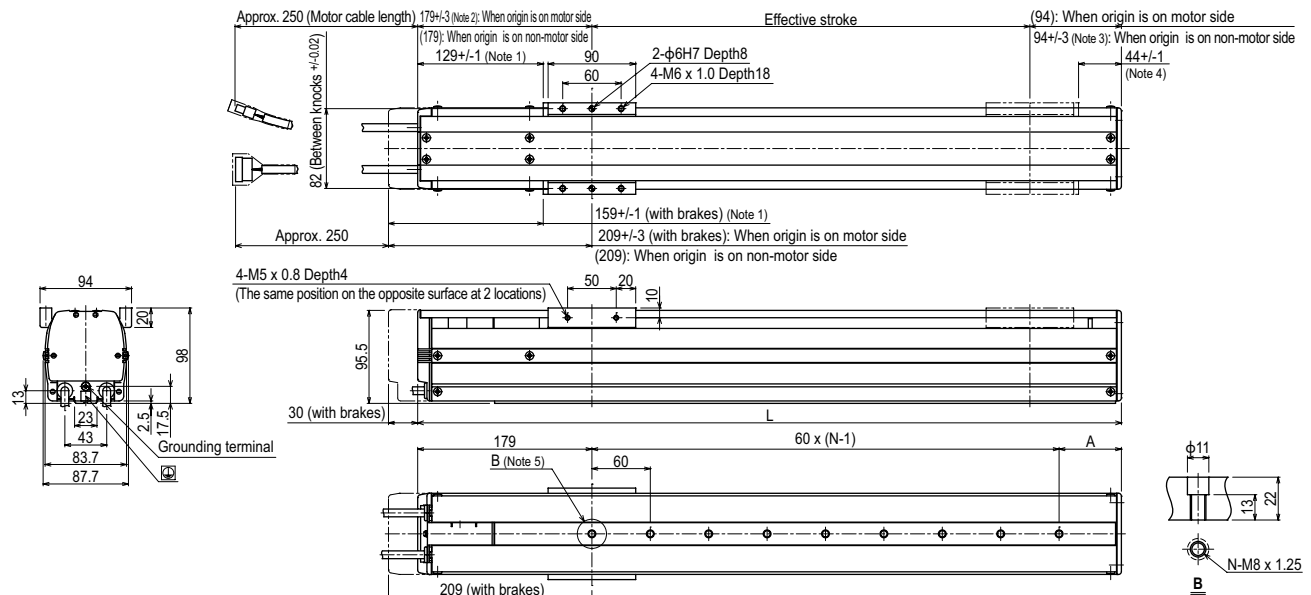

- Note 1. Stop positions are determined by the mechanical stoppers at both ends.
 Note 2. 181.5+/-4 when the high lead specification (Lead 30) is used.
 Note 3. 94+/-4 when the high lead specification (Lead 30) is used.
 Note 4. 41.5+/-1 when the high lead specification (Lead 30) is used.
 Note 5. When installing the unit, washers, etc., cannot be used in the φ11 counter bore hole.
 Note 6. Minimum bend radius of motor cable is R5.
 Note 7. Weight of models with no brake. The weight of brake-attached models is 0.5 kg heavier than the models with no brake shown in the table.

Effective stroke	150	200	250	300	350	400	450	500	550	600	650	700	750	800	850	900	950	1000	1050	1100 ^{Note 9}	1150 ^{Note 9}	1200 ^{Note 9}	1250 ^{Note 9}			
L	423	473	523	573	623	673	723	773	823	873	923	973	1023	1073	1123	1173	1223	1273	1323	1373	1423	1473	1523			
A	64	54	44	94	84	74	64	54	44	94	84	74	64	54	44	94	84	74	64	54	44	94	84			
N	4	5	6	6	7	8	9	10	11	11	12	13	14	15	16	16	17	18	19	20	21	21	22			
Weight (kg) ^{Note 7}	5.8	6.2	6.5	6.9	7.3	7.7	8.0	8.4	8.8	9.1	9.5	9.9	10.2	10.6	11.0	11.4	11.7	12.1	12.5	12.9	13.3	13.7	14.1			
Maximum speed ^{Note 8} (mm/sec)	1800																1440	1170	900	810						
Lead 30	1200																960	780	600	540						
Lead 20	600																480	390	300	270						
Lead 10	300																240	195	150	135						
Lead 5	-																80%	65%	50%	45%						

- Note 8. When the stroke is longer than 700mm, resonance of the ball screw may occur depending on the operation conditions (critical speed). In this case, reduce the speed setting on the program by referring to the maximum speeds shown in the table above.
 Note 9. Strokes longer than 1050mm are special order items. Please contact us for speed setting.

F8

- High lead: Lead 20
- Origin on the non-motor side is selectable



Ordering method

F8	Model	Lead designation	Brake	Origin position change	Grease type	Stroke	Cable length	TSX	SR1-X	RDV-X
		20: 20mm 12: 12mm 6: 6mm	No entry: No brakes BK: Brakes provided	None: Standard Z: Non-motor side	None: Standard GC: Clean	150 to 800 (50mm pitch)	3L: 3.5m 5L: 5m 10L: 10m 3K/5K/10K (Flexible cable)	Positioner TS-X	Controller 05	Driver 2
								Driver: Power-supply voltage / Power capacity 105: 100V/100W or less 205: 200V/100W or less	Driver: Power capacity 05: 100W or less	Driver: Power capacity 2: AC200V
								LCD monitor No entry: None L: With LCD	Usable for CE No entry: Standard E: CE marking	Driver: Power capacity 05: 100W or less
								I/O selection NP: NPN PN: PNP CC: CC-Link DN: DeviceNet™ EP: EtherNet/IP™ PT: PROFINET GW: No I/O board	I/O selection N: NPN P: PNP CC: CC-Link DN: DeviceNet™ PB: PROFIBUS	Regenerative unit RBR1
								Battery B: With battery (Absolute) N: None (Incremental)	Battery B: With battery (Absolute) N: None (Incremental)	

Note 1. The model with a lead of 20mm cannot select specifications with brake (vertical specifications).
 Note 2. The robot cable is standard cable (3L/5L/10L), but can be changed to flexible cable. See P.594 for details on robot cable.
 Note 3. See P.498 for DIN rail mounting bracket.
 Note 4. Select this selection when using the gateway function. For details, see P.60.

Specifications

AC servo motor output (W)	100
Repeatability (mm)	+/-0.02
Deceleration mechanism	Ball screw (Class C10)
Ball screw lead (mm)	20 12 6
Maximum speed (mm/sec)	1200 720 360
Maximum payload (kg)	Horizontal: 12 20 40 Vertical: - 4 8
Rated thrust (N)	84 141 283
Stroke (mm)	150 to 800 (50mm pitch)
Overall length (mm)	Horizontal: Stroke+286 Vertical: Stroke+316
Maximum dimensions of cross section of main unit (mm)	W80 x H65
Cable length (m)	Standard: 3.5 / Option: 5.10
Linear guide type	4 rows of circular arc grooves x 1 rail
Position detector	Resolvers
Resolution (Pulse/rotation)	16384

Note 1. Positioning repeatability in one direction.
 Note 2. When the stroke is longer than 550mm, resonance of the ball screw may occur depending on the operation conditions (critical speed). In this case, reduce the speed setting on the program by referring to the maximum speeds shown in the table above.
 Note 3. Position detectors (resolvers) are common to incremental and absolute specifications. If the controller has a backup function then it will be absolute specifications.

Allowable overhang

	Horizontal installation (Unit: mm)			Wall installation (Unit: mm)			Vertical installation (Unit: mm)					
	A	B	C	A	B	C	A	C				
Lead 20	5kg	197	76	120	5kg	104	67	174	Lead 12	1kg	447	448
	10kg	100	32	54	10kg	37	23	72		2kg	214	216
	12kg	85	25	43	12kg	27	15	55		3kg	137	138
Lead 12	5kg	364	89	188	5kg	171	81	340	Lead 6	4kg	98	99
	10kg	203	39	87	10kg	69	32	172		2kg	244	245
	15kg	139	22	51	15kg	33	15	100		4kg	113	113
Lead 6	20kg	103	14	33	20kg	15	6	55	Lead 6	6kg	69	69
	10kg	403	43	113	10kg	94	36	369		8kg	46	46
	20kg	214	16	43	20kg	25	9	157				
Lead 6	30kg	140	6	20	30kg	0	0	14				
	40kg	113	0	8	40kg	0	0	0				

Note. Distance from center of slider top to center of gravity of object being carried at a guide service life of 10,000 km.

Static loading moment

(Unit: N·m)		
MY	MP	MR
70	95	110

Controller

Controller	Operation method
SR1-X05	Programming / I/O point trace / Remote command / Operation using RS-232C communication
RCX221/222	
RCX240/340	
TS-X105	I/O point trace / Remote command
TS-X205	
RDV-X205-RBR1	Pulse train control

F8

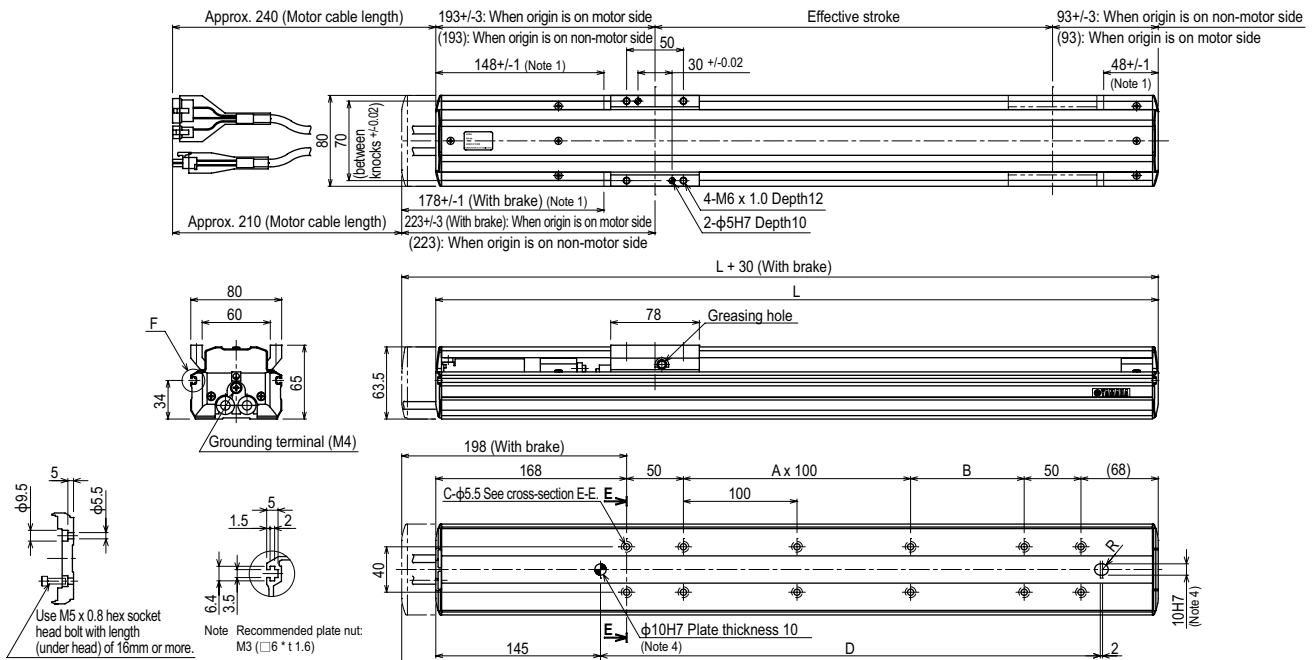

Effective stroke	150	200	250	300	350	400	450	500	550	600	650	700	750	800	
L	436	486	536	586	636	686	736	786	836	886	936	986	1036	1086	
A	0	0	1	1	2	2	3	3	4	4	5	5	6	6	
B	100	150	100	150	100	150	100	150	100	150	100	150	100	150	
C	8	8	10	10	12	12	14	14	16	16	18	18	20	20	
D	240	290	340	390	440	490	540	590	640	690	740	790	840	890	
Weight (kg) (Note 5)	3.6	3.9	4.2	4.4	4.7	5.0	5.3	5.6	5.9	6.2	6.4	6.7	7.0	7.3	
Maximum speed (mm/sec)	Lead 20	1200													
	Lead 12	720													
	Lead 6	360													
	Speed setting	90% 75% 65% 60% 50%													

Note 6. When the stroke is longer than 550mm, resonance of the ball screw may occur depending on the operation conditions (critical speed). In this case, reduce the speed setting on the program by referring to the maximum speeds shown in the table above.

F8L

- High lead: Lead 30
- Origin on the non-motor side is selectable

Ordering method

F8L	Model	Lead designation 30: 30mm 20: 20mm 10: 10mm 5: 5mm	Brake ^{Note 1} No entry: No brakes BK: Brakes provided	Origin position change None: Standard Z: Non-motor side	Grease type None: Standard GC: Clean	Stroke 150 to 1050 (50mm pitch)	Cable length ^{Note 2} 3L: 3.5m 5L: 5m 10L: 10m 3K/5K/10K (Flexible cable)	TSX	Positioner ^{Note 3} TS-X	Driver: Power supply voltage / Power capacity 105: 100V/100W or less 205: 200V/100W or less	LCD monitor No entry: None L: With LCD	I/O selection NP: NPN PN: PNP CC: CC-Link DN: DeviceNet™ EP: EtherNet/IP™ PT: PROFINET GW: No I/O board ^{Note 4}	Battery B: With battery (Absolute) N: None (Incremental)		
	SR1-X	05						Controller	05	Driver: Power capacity 05: 100W or less	Usable for CE No entry: Standard E: CE marking	I/O selection N: NPN P: PNP CC: CC-Link DN: DeviceNet™ PB: PROFIBUS	Battery B: With battery (Absolute) N: None (Incremental)		
	RDV-X	2						Driver	2	Power supply voltage 2: AC200V		05	Driver: Power capacity 05: 100W or less	RBR1	Regenerative unit

- Note 1. The model with a lead of 30mm cannot select specifications with brake (vertical specifications).
 Note 2. The robot cable is standard cable (3L/5L/10L), but can be changed to flexible cable. See P.594 for details on robot cable.
 Note 3. See P.498 for DIN rail mounting bracket.
 Note 4. Select this selection when using the gateway function. For details, see P.60.

Specifications

AC servo motor output (W)	100			
Repeatability ^{Note 1} (mm)	+/-0.01			
Deceleration mechanism	Ball screw (Class C7)			
Ball screw lead (mm)	30	20	10	5
Maximum speed ^{Note 2} (mm/sec)	1800	1200	600	300
Maximum payload (kg)	Horizontal	7	20	40
	Vertical	-	4	8
Rated thrust (N)	Horizontal	56	84	169
	Vertical	-	4	8
Stroke (mm)	150 to 1050 (50mm pitch)			
Overall length (mm)	Horizontal	Stroke+300	Stroke+292	
	Vertical	Stroke+322		
Maximum dimensions of cross section of main unit (mm)	W80 x H65			
Cable length (m)	Standard: 3.5 / Option: 5, 10			
Linear guide type	4 rows of circular arc grooves x 1 rail			
Position detector	Resolvers ^{Note 3}			
Resolution (Pulse/rotation)	16384			

- Note 1. Positioning repeatability in one direction.
 Note 2. When the stroke is longer than 650mm, resonance of the ball screw may occur depending on the operation conditions (critical speed). In this case, reduce the speed setting on the program by referring to the maximum speeds shown in the table below.
 Note 3. Position detectors (resolvers) are common to incremental and absolute specifications. If the controller has a backup function then it will be absolute specifications.

Allowable overhang ^{Note}

Installation	Lead	Horizontal installation (Unit: mm)			Wall installation (Unit: mm)			Vertical installation (Unit: mm)				
		A	B	C	A	B	C	A	B	C		
Horizontal	Lead 30	5kg	112	80	80	5kg	55	57	77	2kg	236	240
	Lead 20	7kg	78	43	49	7kg	21	19	34	4kg	106	110
	Lead 10	5kg	211	108	147	5kg	119	89	176	2kg	310	311
	Lead 5	10kg	116	45	69	10kg	38	26	69	4kg	141	143
	Lead 3	15kg	76	24	39	15kg	7	0	16	6kg	85	86
Wall	Lead 30	20kg	58	14	26	20kg	0	0	0	8kg	57	58
	Lead 20	10kg	251	56	122	10kg	85	39	202	5kg	123	124
	Lead 10	20kg	121	20	46	20kg	7	0	30	10kg	47	48
	Lead 5	30kg	74	8	20	30kg	0	0	0	15kg	22	22
	Lead 3	40kg	35	0	6	40kg	0	0	0	16kg	19	19
Vertical	Lead 30	20kg	249	23	62	20kg	19	7	140	2kg	123	124
	Lead 20	30kg	170	10	29	30kg	0	0	0	4kg	127	128
	Lead 10	40kg	138	4	12	40kg	0	0	0	6kg	85	86
	Lead 5	50kg	51	0	0	50kg	0	0	0	8kg	57	58
	Lead 3	20kg	249	23	62	20kg	19	7	140	2kg	123	124

Note. Distance from center of slider top to center of gravity of object being carried at a guide service life of 10,000 km.

Static loading moment

(Unit: N·m)		
MY	MP	MR
70	95	110

Controller

Controller	Operation method
SR1-X05	Programming / I/O point trace / Remote command / Operation using RS-232C communication
RCX221/222	
RCX240/340	
TS-X105	I/O point trace / Remote command
TS-X205	
RDV-X205-RBR1	Pulse train control

F8L

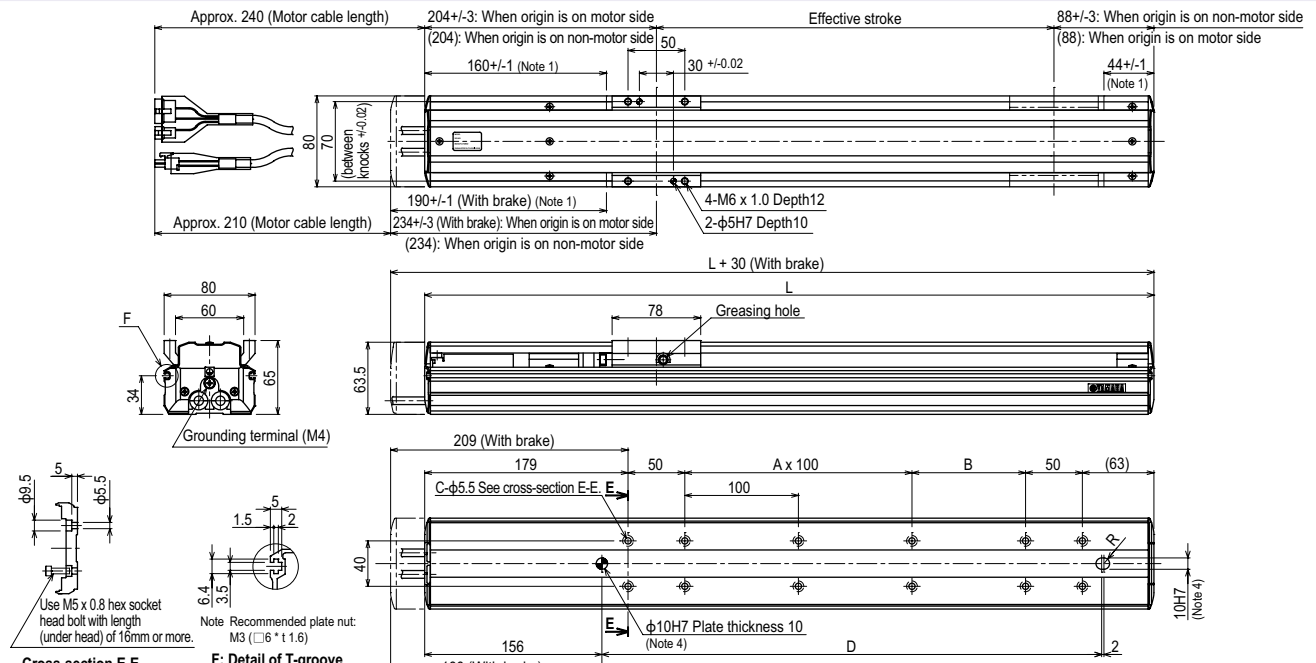

Effective stroke	Cross-section E-E										
	150	200	250	300	350	400	450	500	550	600	
L	442	492	542	592	642	692	742	792	842	892	
A	0	0	1	1	2	2	3	3	4	4	
B	100	150	100	150	100	150	100	150	100	150	
C	8	8	10	10	12	12	14	14	16	16	
D	240	290	340	390	440	490	540	590	640	690	
Weight (kg) ^{Note 5}	Lead 20	3.9	4.2	4.5	4.8	5.1	5.4	5.7	6.1	6.4	
	Lead 10	4.2	4.5	4.8	5.1	5.4	5.7	6.1	6.4	6.7	
Maximum speed ^{Note 6} (mm/sec)	Lead 20	1200									
	Lead 10	600									
	Lead 5	300									
Speed setting	Lead 20	85%									
	Lead 10	75%									
Speed setting	Lead 5	65%									
	Lead 3	60%									

- Note 1. Stop positions are determined by the mechanical stoppers at both ends.
 Note 2. When installing the robot, do not use washers inside the robot body.
 Note 3. Minimum bend radius of motor cable is R50.
 Note 4. When using this φ10 knock-pin hole to position the robot body, the knockpin must not protrude more than 10mm inside the robot body.
 Note 5. Weight of models with no brake. The weight of brake-attached models is 0.3 kg heavier than the models with no brake shown in the table.
 Note 6. When the stroke is longer than 650mm, resonance of the ball screw may occur depending on the operation conditions (critical speed). In this case, reduce the speed setting on the program by referring to the maximum speeds shown in the table above.

F8L High lead type: Lead 30

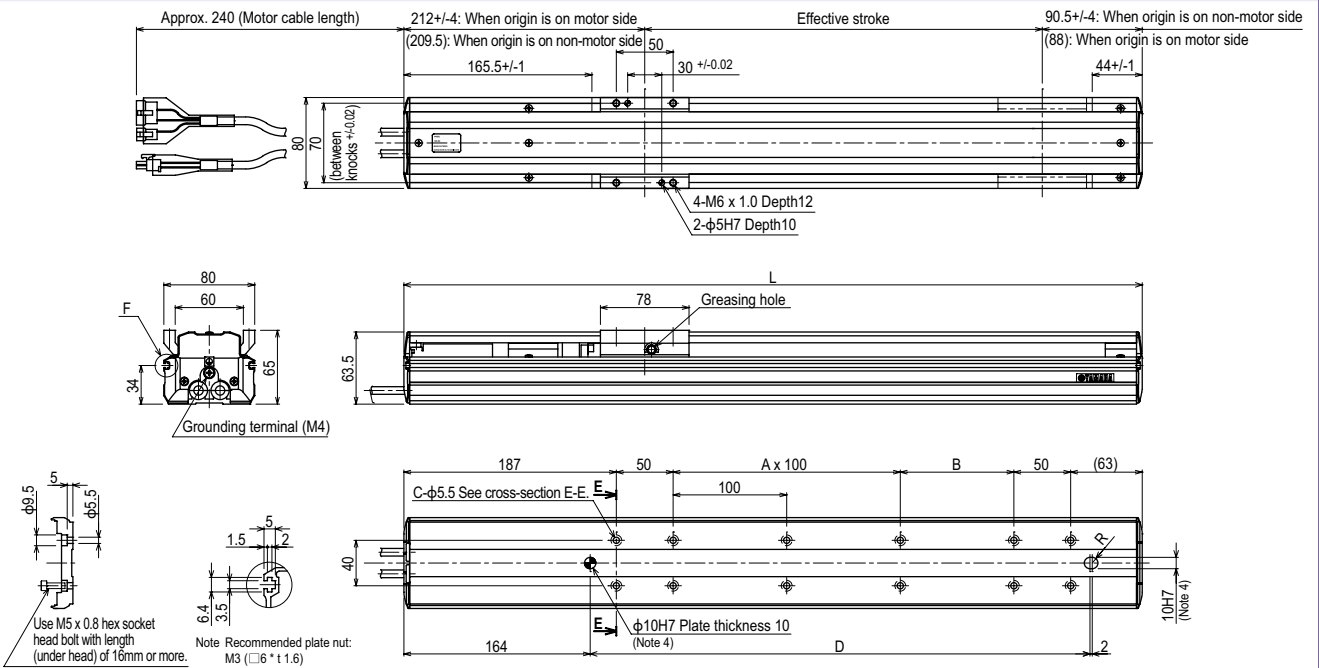

Effective stroke	150	200	250	300	350	400	450	500	550	600	650	700	750	800	850	900	950	1000	1050
L	450	500	550	600	650	700	750	800	850	900	950	1000	1050	1100	1150	1200	1250	1300	1350
A	0	0	1	1	2	2	3	3	4	4	5	5	6	6	7	7	8	8	9
B	100	150	100	150	100	150	100	150	100	150	100	150	100	150	100	150	100	150	100
C	8	8	10	10	12	12	14	14	16	16	18	18	20	20	22	22	24	24	26
D	240	290	340	390	440	490	540	590	640	690	740	790	840	890	940	990	1040	1090	1140
Weight (kg)	3.9	4.2	4.5	4.8	5.1	5.4	5.7	6.1	6.4	6.7	7.0	7.3	7.6	7.9	8.2	8.5	8.8	9.2	9.5
Maximum speed ^{Notes} (mm/sec)	Lead 30	1800										1530	1350	1170	1080	990	900	810	720
	Speed setting	-										85%	75%	65%	60%	55%	50%	45%	40%

Note 1. Stop positions are determined by the mechanical stoppers at both ends.

Note 2. When installing the robot, do not use washers inside the robot body.

Note 3. Minimum bend radius of motor cable is R50.

Note 4. When using this ϕ 10 knockpin hole to position the robot body, the knockpin must not protrude more than 10mm inside the robot body.

Note 5. When the stroke is longer than 650mm, resonance of the ball screw may occur depending on the operation conditions (critical speed). In this case, reduce the speed setting on the program by referring to the maximum speeds shown in the table above.

F8LH

Origin on the non-motor side is selectable

Ordering method

F8LH																			
Model	Lead designation	Origin position change	Grease type	Stroke	Cable length (Note 1)	Positioner (Note 2)	Driver: Power supply voltage / Power capacity	LCD monitor	I/O selection	Battery	Controller	Driver: Power capacity	Usable for CE	I/O selection	Battery	Driver	Power supply voltage	Driver: Power capacity	Regenerative unit
	20: 20mm 10: 10mm 5: 5mm	None: Standard Z: Non-motor side	None: Standard GC: Clean	150 to 1050 (50mm pitch)	3L: 3.5m 5L: 5m 10L: 10m 3K/5K/10K (Flexible cable)	TS-X	105: 100V/100W or less 205: 200V/100W or less	No entry: None L: With LCD	NP: NPN PN: PNP CC: CC-Link DN: DeviceNet™ EP: EtherNet/IP™ PT: PROFINET GW: No I/O board (Note 3)	B: With battery (Absolute) N: None (Incremental)	SR1-X	05: 100W or less	No entry: Standard E: CE marking	N: NPN P: PNP CC: CC-Link DN: DeviceNet™ PB: PROFIBUS	B: With battery (Absolute) N: None (Incremental)	RDV-X	2: AC200V	05: 100W or less	RBR1

Note 1. The robot cable is standard cable (3L/5L/10L), but can be changed to flexible cable. See P.594 for details on robot cable.
 Note 2. See P.498 for DIN rail mounting bracket.
 Note 3. Select this selection when using the gateway function. For details, see P.60.

Specifications

AC servo motor output (W)	100
Repeatability (mm)	+/-0.01
Deceleration mechanism	Ball screw (Class C7)
Ball screw lead (mm)	20 10 5
Maximum speed (mm/sec)	1200 600 300
Maximum payload (kg)	Horizontal 30 60 80
Rated thrust (N)	84 169 339
Stroke (mm)	150 to 1050 (50mm pitch)
Overall length (mm)	Horizontal Stroke+368
Maximum dimensions of cross section of main unit (mm)	W80 x H65
Cable length (m)	Standard: 3.5 / Option: 5.10
Linear guide type	4 rows of circular arc grooves x 1 rail
Position detector	Resolvers (Note 3)
Resolution (Pulse/rotation)	16384

Note 1. Positioning repeatability in one direction.
 Note 2. When the stroke is longer than 800mm, resonance of the ball screw may occur depending on the operation conditions (critical speed). In this case, reduce the speed setting on the program by referring to the maximum speeds shown in the table below.
 Note 3. Position detectors (resolvers) are common to incremental and absolute specifications. If the controller has a backup function then it will be absolute specifications.

Allowable overhang (Note)

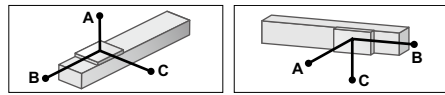

	Horizontal installation (Unit: mm)			Wall installation (Unit: mm)		
	A	B	C	A	B	C
Lead 20						
10kg	573	256	176	10kg	147	215 515
20kg	334	116	81	20kg	53	75 255
30kg	279	70	50	30kg	20	29 160
Lead 10						
20kg	629	137	111	20kg	80	99 545
20kg	479	57	47	40kg	15	19 270
60kg	382	30	25	60kg	-	-
Lead 5						
20kg	1094	148	127	20kg	96	112 1005
40kg	851	63	54	40kg	22	26 604
60kg	714	34	29	60kg	-	-
80kg	601	20	17	80kg	-	-

Note. Distance from center of slider top to center of gravity of object being carried at a guide service life of 10,000 km.

Static loading moment

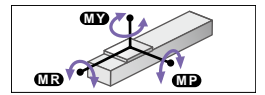

(Unit: N·m)		
MY	MP	MR
128	163	143

Controller

Controller	Operation method
SR1-X05	Programming / I/O point trace / Remote command / Operation using RS-232C communication
RCX221/222	
RCX240/340	
TS-X105	I/O point trace / Remote command
TS-X205	
RDV-X205-RBR1	Pulse train control

F8LH

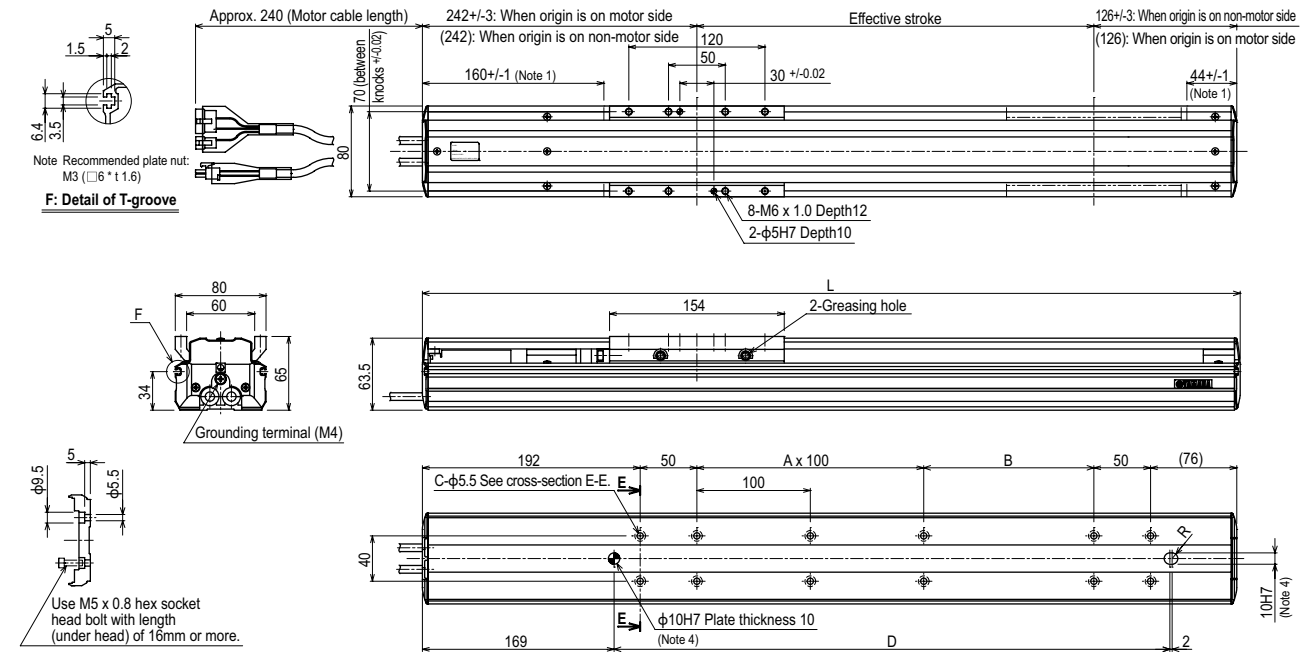

Cross-section E-E

Effective stroke	150	200	250	300	350	400	450	500	550	600	650	700	750	800	850	900	950	1000	1050	
L	518	568	618	668	718	768	818	868	918	968	1018	1068	1118	1168	1218	1268	1318	1368	1418	
A	0	1	1	2	2	3	3	4	4	5	5	6	6	7	7	8	8	9	9	
B	150	100	150	100	150	100	150	100	150	100	150	100	150	100	150	100	150	100	150	
C	8	10	10	12	12	14	14	16	16	18	18	20	20	22	22	24	24	26	26	
D	290	340	390	440	490	540	590	640	690	740	790	840	890	940	990	1040	1090	1140	1190	
Weight (kg)	4.7	5.0	5.3	5.6	5.9	6.2	6.6	6.9	7.2	7.5	7.8	8.1	8.4	8.7	9.0	9.3	9.7	10.0	10.3	
Maximum speed (mm/sec)	Lead 20	1200										1020	900	780	720	660	600	540	480	420
	Lead 10	600										510	450	390	360	330	300	270	240	210
	Lead 5	300										255	225	195	180	165	150	135	120	105
	Speed setting	-										85%	75%	65%	60%	55%	50%	45%	40%	35%

Note 1. Stop positions are determined by the mechanical stoppers at both ends.
 Note 2. When installing the robot, do not use washers inside the robot body.
 Note 3. Minimum bend radius of motor cable is R50.
 Note 4. When using this φ10 knock-pin hole to position the robot body, the knock-pin must not protrude more than 10mm inside the robot body.

Note 5. When the stroke is longer than 600mm, resonance of the ball screw may occur depending on the operation conditions (critical speed). In this case, reduce the speed setting on the program by referring to the maximum speeds shown in the table above.

F10

● High lead: Lead 30

● Origin on the non-motor side is selectable: Lead 10-20-30

Note. Strokes longer than 1050mm are special order items. Please consult us for delivery time.

Ordering method

F10

Model	Lead designation	Brake	Cable entry location	Origin position change	Grease type	Stroke	Cable length
	30: 30mm 20: 20mm 10: 10mm 5: 5mm	No entry: No brakes BK: Brakes provided	No entry: Standard (S) U: From the top	None: Standard Z: Non-motor side	None: Standard GC: Clean	Lead 20-10-5: 150 to 1050 (50mm pitch) Lead 30: 150 to 1250 (50mm pitch)	3L: 3.5m 5L: 5m 10L: 10m 3K/5K/10K (Flexible cable)

- Note 1. The model with a lead of 30mm cannot select specifications with brake (vertical specifications).
 Note 2. If selecting 5mm lead specifications then the origin point cannot be changed to the non-motor side.
 Note 3. The robot cable is standard cable (3L/5L/10L), but can be changed to flexible cable. See P.594 for details on robot cable.
 Note 4. See P.498 for DIN rail mounting bracket.
 Note 5. Select this selection when using the gateway function. For details, see P.60.

TSX

Positioner	Driver: Power-supply voltage	Regenerative unit	LCD monitor	I/O selection	Battery
TS-X	Power capacity 105: 100V/100W or less 205: 200V/100W or less	No entry: None R: With RGT	No entry: None L: With LCD	NP: NPN PN: PNP CC: CC-Link DN: DeviceNet™ EP: EtherNet/IP™ PT: PROFINET GW: No I/O board	B: With battery (Absolute) N: None (Incremental)

SR1-X

Controller	Driver: Power capacity	Usable for CE	Regenerative unit	I/O selection	Battery
05	05: 100W or less	No entry: Standard E: CE marking	No entry: None R: With RGT	N: NPN P: PNP CC: CC-Link DN: DeviceNet™ PB: PROFIBUS	B: With battery (Absolute) N: None (Incremental)

RDV-X

Driver	Power-supply voltage	Driver: Power capacity	Regenerative unit
2	2: AC200V	05: 100W or less	

Specifications

AC servo motor output (W)	100
Repeatability (mm)	+/-0.01
Deceleration mechanism	Ball screw (Class C7)
Ball screw lead (mm)	30 20 10 5
Maximum speed (mm/sec)	1800 1200 600 300
Maximum payload (kg)	Horizontal: 15 20 40 60 Vertical: - 4 10 20
Rated thrust (N)	56 84 169 339
Stroke (mm)	150 to 1250 (50mm pitch)
Overall length (mm)	Horizontal: Stroke+260 Vertical: Stroke+290
Maximum dimensions of cross section of main unit (mm)	W110 x H71
Cable length (m)	Standard: 3.5 / Option: 5.10
Linear guide type	4 rows of circular arc grooves x 1 rail
Position detector	Resolvers
Resolution (Pulse/rotation)	16384

- Note 1. Positioning repeatability in one direction.
 Note 2. When the stroke is longer than 700mm, resonance of the ball screw may occur depending on the operation conditions (critical speed). In this case, reduce the speed setting on the program by referring to the maximum speeds shown in the table below.
 Note 3. Strokes longer than 1050mm are available only for high lead (Lead 30). (Special order item)
 Note 4. Position detectors (resolvers) are common to incremental and absolute specifications. If the controller has a backup function then it will be absolute specifications.

Allowable overhang

Lead	Horizontal installation (Unit: mm)			Wall installation (Unit: mm)			Vertical installation (Unit: mm)		
	A	B	C	A	B	C	A	B	C
Lead 30	5kg 491	273	215	5kg 206	209	480	1kg 600	600	600
Lead 20	15kg 223	61	63	15kg 45	0	177	2kg 649	691	
	5kg 937	282	259	5kg 250	213	905	4kg 306	347	
Lead 10	10kg 487	121	116	10kg 99	51	438	8kg 142	183	
	20kg 236	40	44	20kg 21	0	149	10kg 102	144	
Lead 5	15kg 389	71	74	10kg 105	53	550	10kg 105	146	
	30kg 179	17	20	20kg 22	0	230	15kg 51	93	
Lead 5	40kg 106	0	0	30kg 0	0	0	20kg 25	66	
	30kg 419	19	20	10kg 107	54	1410			
Lead 5	50kg 0	0	0	20kg 22	0	540			
	60kg 0	0	0	30kg 0	0	0			

Note. Distance from center of slider top to center of gravity of object being carried at a guide service life of 10,000 km.

Static loading moment

	MY	MP	MR
(Unit: N·m)	131	131	115

Controller

Controller	Operation method
SR1-X05 RCX221/222 RCX240/340	Programming / I/O point trace / Remote command / Operation using RS-232C communication
TS-X105 TS-X205 RDV-X205-RBR1	I/O point trace / Remote command / Pulse train control

Note. Regenerative unit is required when the models used vertically and with 700mm or larger stroke.

F10

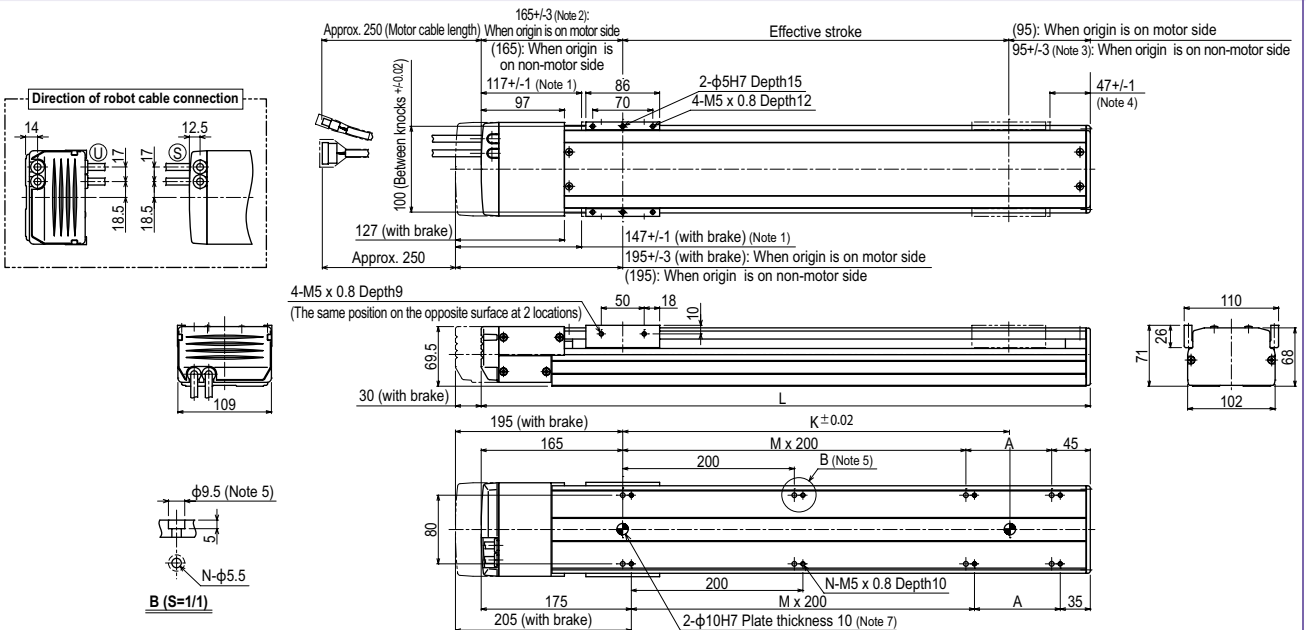

Note 1. Stop positions are determined by the mechanical stoppers at both ends.
 Note 2. 167.5+/-4 when the high lead specification (Lead 30) is used.
 Note 3. 95+/-4 when the high lead specification (Lead 30) is used.
 Note 4. 44.5+/-1 when the high lead specification (Lead 30) is used.
 Note 5. When installing the unit, washers, etc., cannot be used in the $\phi 9.5$ counter bore hole.
 Note 6. Minimum bend radius of motor cable is R50.
 Note 7. When using this $\phi 10$ knock-pin hole to position the robot body, the knockpin must not protrude more than 10mm inside the robot body.
 Note 8. Weight of models with no brake. The weight of brake-attached models is 0.6 kg heavier than the models with no brake shown in the table below.

Effective stroke	150	200	250	300	350	400	450	500	550	600	650	700	750	800	850	900	950	1000	1050	1100	1150	1200	1250
L	410	460	510	560	610	660	710	760	810	860	910	960	1010	1060	1110	1160	1210	1260	1310	1360	1410	1460	1510
A	200	50	100	150	200	50	100	150	200	50	100	150	200	50	100	150	200	50	100	150	200	50	100
M	0	1	1	1	1	2	2	2	2	3	3	3	3	4	4	4	4	5	5	5	5	6	6
N	4	6	6	6	6	8	8	8	8	10	10	10	10	12	12	12	12	14	14	14	14	16	16
K	150	200	250	300	350	400	450	500	550	600	650	700	750	800	850	900	950	1000	1050	1100	1150	1200	1250
Weight (kg)	5.5	5.7	5.8	6.2	6.5	6.9	7.3	7.7	8.1	8.5	8.8	9.2	9.6	10.0	10.4	10.8	11.1	11.5	11.9	12.3	12.7	13.1	13.5
Maximum speed (mm/sec)	Lead 30	1800										1440	1170	900	810								
	Lead 20	1200										960	780	600	540								
	Lead 10	600										480	390	300	270								
	Lead 5	300										240	195	150	135								
Speed setting											80%	65%	50%	45%									

Note 9. When the stroke is longer than 700mm, resonance of the ball screw may occur depending on the operation conditions (critical speed). In this case, reduce the speed setting on the program by referring to the maximum speeds shown in the table above.
 Note 10. Strokes longer than 1050mm are special order items. Please contact us for speed setting.

F10H

- High lead: Lead 30
- Origin on the non-motor side is selectable: Lead 10-20-30

Ordering method

F10H

Model	Lead designation	Brake	Cable entry location	Origin position change	Grease type	Stroke	Cable length
	30: 30mm 20: 20mm 10: 10mm 5: 5mm	No entry: No brakes BK: Brakes provided	No entry: Standard (S) U: From the top	None: Standard Z: Non-motor side	None: Standard GC: Clean	Lead 20-10-5: 150 to 1000 (50mm pitch) Lead 30: 150 to 1000 (50mm pitch)	3L: 3.5m 5L: 5m 10L: 10m 3K/5K/10K (Flexible cable)

TSX

Positioner	Driver: Power-supply voltage / Power capacity	Regenerative unit	LCD monitor	I/O selection	Battery
TS-X	110: 100V/200W 210: 200V/200W	No entry: None R: With RGT	No entry: None L: With LCD	N: NPN P: PNP CC: CC-Link DN: DeviceNet™ EP: EtherNet/IP™ PT: PROFINET GW: No I/O board	B: With battery (Absolute) N: None (Incremental)

SR1-X 10

Controller	Driver: Power capacity	Usable for CE	Regenerative unit	I/O selection	Battery
	10: 200W	No entry: Standard E: CE marking	No entry: None R: With RGT	N: NPN P: PNP CC: CC-Link DN: DeviceNet™ PB: Profibus	B: With battery (Absolute) N: None (Incremental)

RDV-X 2 10 RBR1

Driver	Power-supply voltage	Driver: Power capacity	Regenerative unit
	2: AC200V	10: 200W or less	

Note 1. The model with a lead of 30mm cannot select specifications with brake (vertical specifications).
 Note 2. If selecting 5mm lead specifications then the origin point cannot be changed to the non-motor side.
 Note 3. The robot cable is standard cable (3L/5L/10L), but can be changed to flexible cable. See P.594 for details on robot cable.
 Note 4. See P.498 for DIN rail mounting bracket.
 Note 5. Select this selection when using the gateway function. For details, see P.60.

Specifications

AC servo motor output (W)	200		
Repeatability (mm)	±0.01		
Deceleration mechanism	Ball screw (Class C7)		
Ball screw lead (mm)	30	20	10
Maximum speed (mm/sec)	1800	1200	600
Maximum payload (kg)	Horizontal	Vertical	
	25	40	80
	8	20	30
Rated thrust (N)	113	170	341
Stroke (mm)	150 to 1000		
Overall length (mm)	Horizontal	Stroke+355	
	Vertical	Stroke+385	
Maximum dimensions of cross section of main unit (mm)	W110 × H71		
Cable length (m)	Standard: 3.5 / Option: 5.10		
Linear guide type	4 rows of circular arc grooves × 1 rail		
Position detector	Resolvers		
Resolution (Pulse/rotation)	16384		

Note 1. Positioning repeatability in one direction.
 Note 2. When the stroke is longer than 600mm, resonance of the ball screw may occur depending on the operation conditions (critical speed). In this case, reduce the speed setting on the program by referring to the maximum speeds shown in the table below. When the movement distance is short, the speed may not reach the maximum speed according to the payload.
 Note 3. Position detectors (resolvers) are common to incremental and absolute specifications. If the controller has a backup function then it will be absolute specifications.

Allowable overhang

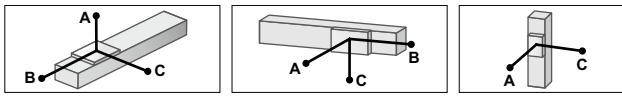

Installation	Horizontal installation (Unit: mm)			Wall installation (Unit: mm)			Vertical installation (Unit: mm)					
	A	B	C	A	B	C	A	C				
Lead 30	10kg	1181	681	219	10kg	193	570	1062	Lead 20	4kg	1650	1650
	20kg	772	298	99	20kg	65	187	549		6kg	1104	1104
	10kg	1961	685	232	10kg	198	570	1786		8kg	832	832
Lead 20	20kg	949	301	103	20kg	65	187	732	10kg	927	927	
	40kg	432	109	38	40kg	0	0	0	15kg	614	614	
	30kg	1615	239	84	30kg	100	283	1981	20kg	458	458	
Lead 10	50kg	1131	112	39	50kg	66	187	1546	15kg	752	752	
	80kg	812	40	14	30kg	43	123	1223	20kg	560	560	
	60kg	3091	112	39	20kg	134	379	7629	30kg	369	369	
Lead 5	80kg	2330	64	23	25kg	93	264	5987				
	100kg	1733	36	12	30kg	66	187	4841				

Note. Distance from center of slider top to center of gravity of object being carried at a guide service life of 10,000 km.

Static loading moment

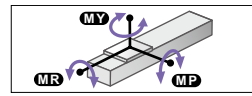

(Unit: N-m)		
MY	MP	MR
348	348	160

Controller

Controller	Operation method
SR1-X10 Note RCX221/222 RCX240/340	Programming / I/O point trace / Remote command / Operation using RS-232C communication
TS-X110 Note TS-X210 Note RDV-X210- RBR1	I/O point trace / Remote command / Pulse train control

Note. When using the unit vertically, a regeneration unit is required.

F10H

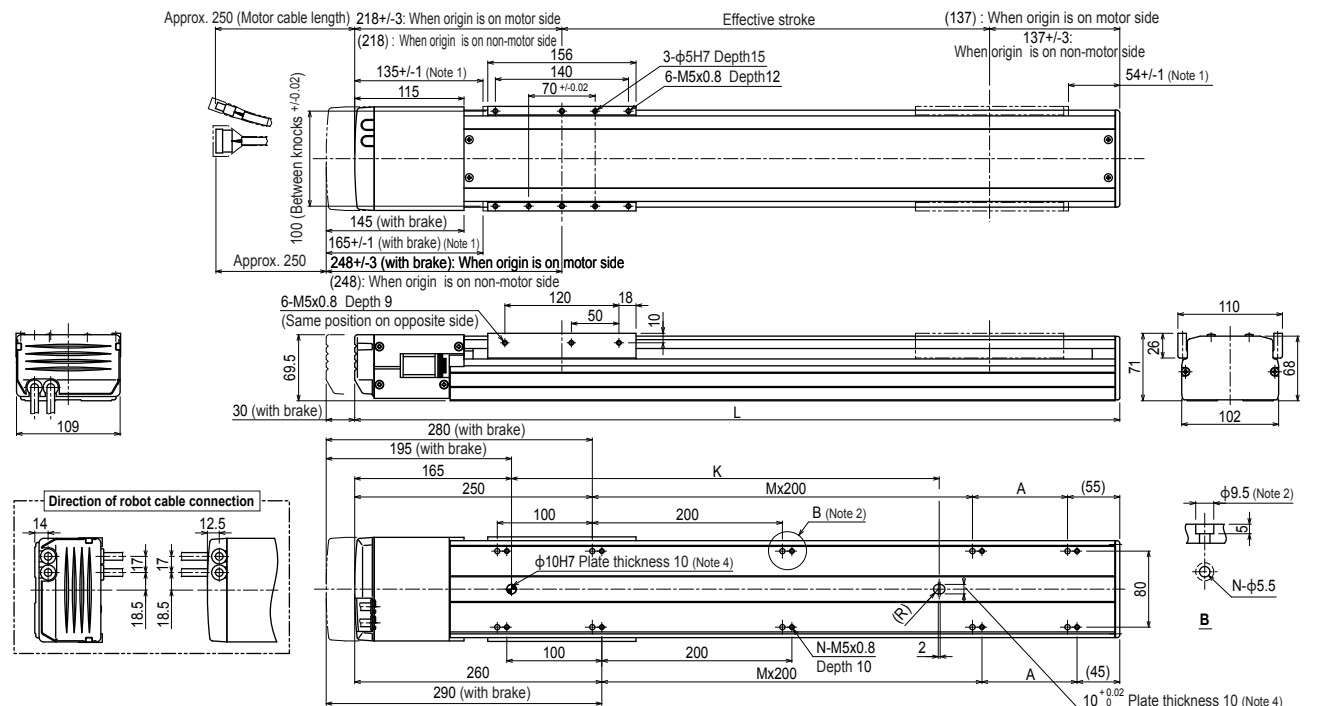

Note 1. Stop positions are determined by the mechanical stoppers at both ends. When installing the unit, washers, etc. cannot be used in the $\phi 9.5$ counter bore hole.
 Note 2. Minimum bend radius of motor cable is R50.
 Note 3. When using this $\phi 10$ knock-pin hole to position the robot body, the knockpin must not protrude more than 10mm inside the robot body.
 Note 4. Weight of models with no brake. The weight of brake-attached models is 0.5 kg heavier than the models with no brake shown in the table.
 Note 5. Weight of models with no brake. The weight of brake-attached models is 0.5 kg heavier than the models with no brake shown in the table.

Note 6. When the stroke is longer than 600mm, resonance of the ball screw may occur depending on the operation conditions (critical speed). In this case, reduce the speed setting on the program by referring to the maximum speeds shown in the table above.

F10H High lead type: Lead 30

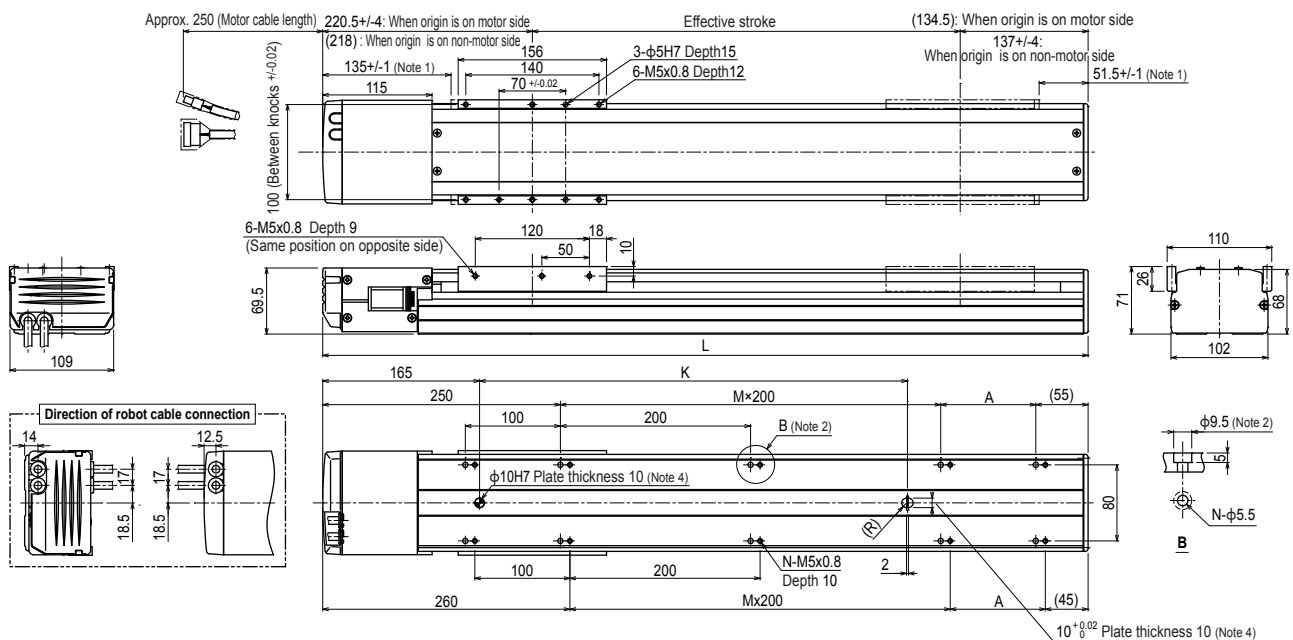

Effective stroke	150	200	250	300	350	400	450	500	550	600	650	700	750	800	850	900	950	1000		
L	505	555	605	655	705	755	805	855	905	955	1005	1055	1105	1155	1205	1255	1305	1355		
A	200	50	100	150	200	50	100	150	200	50	100	150	200	50	100	150	200	50		
M	0	1	1	1	1	2	2	2	3	3	3	3	3	4	4	4	4	5		
N	6	8	8	8	8	10	10	10	10	12	12	12	12	14	14	14	14	16		
K	250	300	350	400	450	500	550	600	650	700	750	800	850	900	950	1000	1050	1100		
Weight (kg)	6.9	7.3	7.7	8.1	8.4	8.8	9.2	9.6	10.0	10.3	10.7	11.1	11.5	11.9	12.2	12.6	13.0	13.4		
Maximum speed (mm/sec)	Lead 30											1440	1260	1080	900	720	630			
	Lead 20											960	840	720	600	480	420			
	Lead 10											480	420	360	300	240	210			
	Lead 5											240	210	180	150	120	105			
	Speed setting											80%	70%	60%	50%	40%	35%			

Note 1. Stop positions are determined by the mechanical stoppers at both ends.
 Note 2. When installing the unit, washers, etc., cannot be used in the φ9.5 counter bore hole.
 Note 3. Minimum bend radius of motor cable is R50.
 Note 4. When using this φ10 knock-pin hole to position the robot body, the knock-pin must not protrude more than 10mm inside the robot body.

F14

- High lead: Lead 30
- Origin on the non-motor side is selectable

Note. Strokes longer than 1050mm are special order items. Please consult us for delivery time.



Ordering method

F14

Model	Lead designation	Brake	Cable entry location	Origin position change	Grease type	Stroke	Cable length
	30: 30mm 20: 20mm 10: 10mm 5: 5mm	No entry: No brakes BK: Brakes provided	No entry: (Standard (S)) U: From the top R: From the right L: From the left	None: Standard Z: Non-motor side	None: Standard GC: Clean	Lead 20: 10:5 150 to 1050 (50mm pitch) Lead 30: 150 to 1250 (50mm pitch)	3L: 3.5m 5L: 5m 10L: 10m BK/5K/10K (Flexible cable)

TSX

Positioner	Driver: Power supply voltage Power capacity	Regenerative unit	LCD monitor	I/O selection	Battery
TS-X	105: 100V/100W or less 205: 200V/100W or less	No entry: None R: With RGT	No entry: None L: With LCD	NP: NPN PN: PNP CC: CC-Link DN: DeviceNet™ EP: EtherNet/IP™ PT: PROFINET GW: No I/O board	B: With battery (Absolute) N: None (Incremental)

SR1-X

Controller	Driver: Power capacity	Usable for CE	Regenerative unit	I/O selection	Battery
05	05: 100W or less	No entry: Standard E: CE marking	No entry: None R: With RGT1	N: NPN P: PNP CC: CC-Link DN: DeviceNet™ PB: PROFIBUS	B: With battery (Absolute) N: None (Incremental)

RDV-X

Driver	Power supply voltage	Driver: Power capacity	Regenerative unit
2	2: AC200V	05: 100W or less	RBR1

- Note 1. The model with a lead of 30mm cannot select specifications with brake (vertical specifications).
 Note 2. The robot cable is standard cable (3L/5L/10L), but can be changed to flexible cable. See P.594 for details on robot cable.
 Note 3. See P.498 for DIN rail mounting bracket.
 Note 4. Select this selection when using the gateway function. For details, see P.60.

Specifications

AC servo motor output (W)	100
Repeatability (mm)	+/-0.01
Deceleration mechanism	Ball screw (Class C7)
Ball screw lead (mm)	30 20 10 5
Maximum speed (mm/sec)	1800 1200 600 300
Maximum payload (kg)	Horizontal: 15 30 55 80 Vertical: - 4 10 20
Rated thrust (N)	56 84 169 339
Stroke (mm)	150 to 1250 (50mm pitch)
Overall length (mm)	Horizontal: Stroke+255 Vertical: Stroke+285
Maximum dimensions of cross section of main unit (mm)	W136 x H83
Cable length (m)	Standard: 3.5 / Option: 5.10
Linear guide type	4 rows of circular arc grooves x 2 rail
Position detector	Resolvers
Resolution (Pulse/rotation)	16384

- Note 1. Positioning repeatability in one direction.
 Note 2. When the stroke is longer than 700mm, resonance of the ball screw may occur depending on the operation conditions (critical speed). In this case, reduce the speed setting on the program by referring to the maximum speeds shown in the table below.
 Note 3. Strokes longer than 1050mm are available only for high lead (Lead 30). (Special order item)
 Note 4. Position detectors (resolvers) are common to incremental and absolute specifications. If the controller has a backup function then it will be absolute specifications.

Allowable overhang

Lead	Horizontal installation (Unit: mm)			Wall installation (Unit: mm)			Vertical installation (Unit: mm)		
	A	B	C	A	B	C	A	B	C
Lead 30	5kg 1756	1364	863	5kg 951	969	1286	1kg 600	600	600
Lead 20	15kg 1236	467	438	5kg 1066	974	1578	2kg 1200	1200	1200
Lead 10	5kg 2153	1366	980	15kg 402	276	775	4kg 1154	895	895
Lead 5	15kg 1193	465	430	30kg 219	105	678	8kg 634	492	492
Lead 30	20kg 1132	353	361	40kg 140	57	402	10kg 499	387	387
Lead 20	40kg 872	183	218	55kg 92	0	345	10kg 587	456	456
Lead 10	55kg 946	140	184	30kg 246	107	1095	15kg 383	297	297
Lead 5	50kg 1575	158	222	40kg 167	64	798	20kg 281	218	218
Lead 30	60kg 1493	135	194	60kg 88	20	508			
Lead 20	80kg 1466	107	159						

Note. Distance from center of slider top to center of gravity of object being carried at a guide service life of 10,000 km.

Static loading moment

(Unit: N·m)		
MY	MP	MR
232	233	204

Controller

Controller	Operation method
SR1-X05 RCX221/222 RCX240/340	Programming / I/O point trace / Remote command / Operation using RS-232C communication
TS-X105 TS-X205 RDV-X05-RBR1	I/O point trace / Remote command / Pulse train control

Note. Regenerative unit is required when the models used vertically and with 700mm or larger stroke.

F14

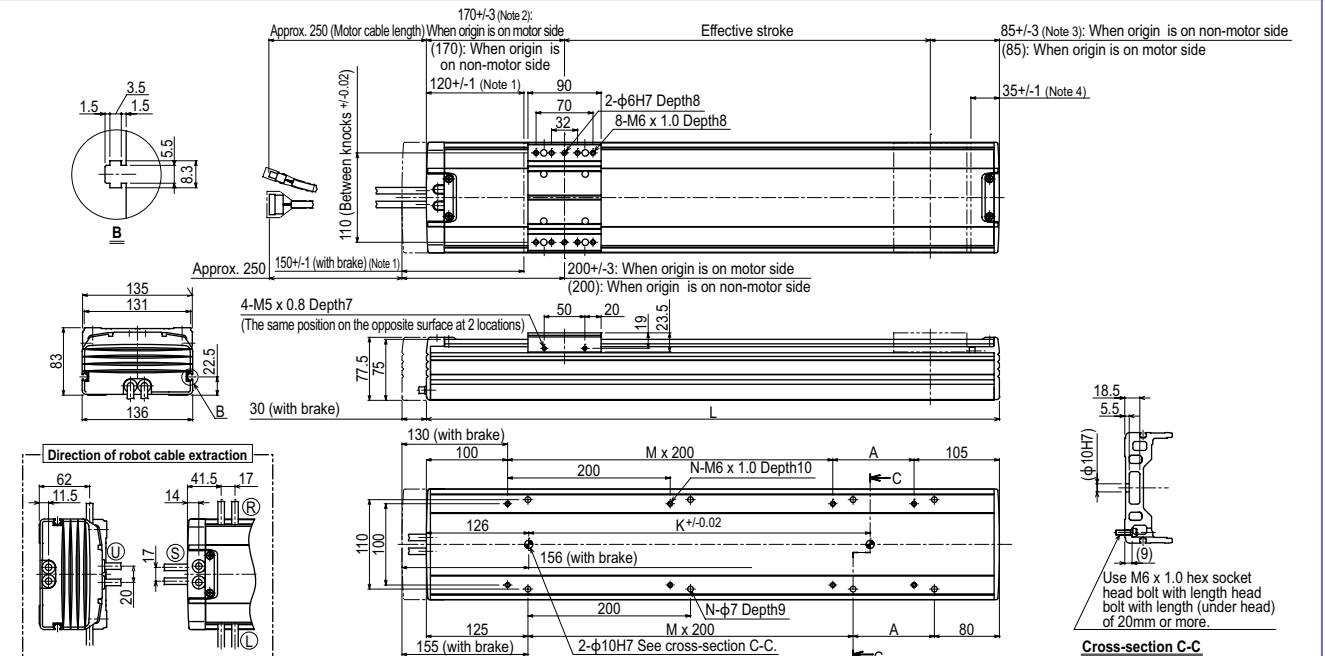

- Note 1. Stop positions are determined by the mechanical stoppers at both ends.
 Note 2. 172.5+/-4 when the high lead specification (Lead 30) is used.
 Note 3. 85+/-4 when the high lead specification (Lead 30) is used.
 Note 4. 32.5+/-1 when the high lead specification (Lead 30) is used.
 Note 5. Minimum bend radius of motor cable is R50.
 Note 6. Weight of models with no brake. The weight of brake-attached models is 0.7 kg heavier than the models with no brake shown in the table.

Effective stroke	150	200	250	300	350	400	450	500	550	600	650	700	750	800	850	900	950	1000	1050	1100	1150	1200	1250
L	405	455	505	555	605	655	705	755	805	855	905	955	1005	1055	1105	1155	1205	1255	1305	1355	1405	1455	1505
A	200	50	100	150	200	50	100	150	200	50	100	150	200	50	100	150	200	50	100	150	200	50	100
M	0	1	1	1	1	2	2	2	2	3	3	3	3	4	4	4	4	5	5	5	5	6	6
N	4	6	6	6	6	8	8	8	8	10	10	10	10	12	12	12	12	14	14	14	14	16	16
K	240	240	240	240	420	420	420	420	600	600	600	600	780	780	780	780	960	960	960	960	1140	1140	1140
Weight (kg)	6.2	6.9	7.5	8.2	8.8	9.5	10.1	10.8	11.4	12.1	12.6	13.4	13.9	14.6	15.2	15.9	16.5	17.2	17.8	18.5	19.1	19.8	20.4
Maximum speed (mm/sec)	Lead 30	1800												1440	1170	900	810						
	Lead 20	1200												960	780	600	540						
	Lead 10	600												480	390	300	270						
	Lead 5	300												240	195	150	135						
Speed setting														80%	65%	50%	45%						

Note 7. When the stroke is longer than 700mm, resonance of the ball screw may occur depending on the operation conditions (critical speed). In this case, reduce the speed setting on the program by referring to the maximum speeds shown in the table above.
 Note 8. Strokes longer than 1050mm are special order items. Please contact us for speed setting.

F14H

● High lead: Lead 30

● Origin on the non-motor side is selectable: Lead 10-20-30

Note. Strokes longer than 1050mm are special order items. Please consult us for delivery time.



Ordering method

F14H

Model	Lead designation	Brake	Cable entry location	Origin position change	Grease type	Stroke	Cable length
	30: 30mm 20: 20mm 10: 10mm 5: 5mm	No entry: No brakes BK: Brakes provided	No entry: Standard (S) U: From the top R: From the right L: From the left	None: Standard Z: Non-motor side	None: Standard GC: Clean	Lead 20-10-5: 150 to 1050 (50mm pitch) Lead 30: 150 to 1250 (50mm pitch)	3L: 3.5m 5L: 5m 10L: 10m 3K/5K/10K (Flexible cable)

- Note 1. The model with a lead of 30mm cannot select specifications with brake (vertical specifications).
 Note 2. If selecting 5mm lead specifications then the origin point cannot be changed to the non-motor side.
 Note 3. The robot cable is standard cable (3L/5L/10L), but can be changed to flexible cable. See P.594 for details on robot cable.
 Note 4. See P.498 for DIN rail mounting bracket.
 Note 5. Select this selection when using the gateway function. For details, see P.60.

TSX

Positioner	Driver: Power-supply voltage	Regenerative unit	LCD monitor	I/O selection	Battery
TS-X	Power capacity 110: 100V/200W 210: 200V/200W	No entry: None R: With RGT	No entry: None L: With LCD	NP: NPN PN: PNP CC: CC-Link DN: DeviceNet™ EP: EtherNet/IP™ PT: PROFINET GW: No I/O board	B: With battery (Absolute) N: None (Incremental)

SR1-X

Controller	Driver: Power capacity	Usable for CE	Regenerative unit	I/O selection	Battery
10	10: 200W	No entry: Standard E: CE marking	No entry: None R: With RGT	N: NPN P: PNP CC: CC-Link DN: DeviceNet™ PB: PROFINET	B: With battery (Absolute) N: None (Incremental)

RDV-X

Driver	Power-supply voltage	Driver: Power capacity	Regenerative unit
2	2: AC200V	10: 200W or less	

Specifications

AC servo motor output (W)	200
Repeatability (mm)	+/-0.01
Deceleration mechanism	Ball screw (Class C7)
Ball screw lead (mm)	30 20 10 5
Maximum speed (mm/sec)	1800 1200 600 300
Maximum payload (kg)	Horizontal: 25 40 80 100 Vertical: - 8 20 30
Rated thrust (N)	113 170 341 683
Stroke (mm)	150 to 1250 (50mm pitch)
Overall length (mm)	Horizontal: Stroke+320 Vertical: Stroke+350
Maximum dimensions of cross section of main unit (mm)	W136 x H83
Cable length (m)	Standard: 3.5 / Option: 5.10
Linear guide type	4 rows of circular arc grooves x 2 rail
Position detector	Resolvers
Resolution (Pulse/rotation)	16384

- Note 1. Positioning repeatability in one direction.
 Note 2. When the stroke is longer than 700mm, resonance of the ball screw may occur depending on the operation conditions (critical speed). In this case, reduce the speed setting on the program by referring to the maximum speeds shown in the table below.
 Note 3. Strokes longer than 1050mm are available only for high lead (Lead 30). (Special order item)
 Note 4. Position detectors (resolvers) are common to incremental and absolute specifications. If the controller has a backup function then it will be absolute specifications.

Allowable overhang

Lead	Horizontal installation (Unit: mm)			Wall installation (Unit: mm)			Vertical installation (Unit: mm)		
	A	B	C	A	B	C	A	C	
Lead 30	10kg: 2152	1673	934	10kg: 975	1219	1625	4kg: 2400	2016	
Lead 20	25kg: 1847	691	533	25kg: 482	426	1257	6kg: 1699	1364	
	10kg: 2265	1674	961	10kg: 999	1220	1711	8kg: 1301	1051	
Lead 10	20kg: 1402	855	537	20kg: 515	558	987	10kg: 1370	1106	
	40kg: 1047	445	324	40kg: 263	227	635	15kg: 906	732	
Lead 5	30kg: 1953	583	485	30kg: 419	338	1282	20kg: 678	548	
	50kg: 1655	365	328	50kg: 240	162	934	20kg: 767	619	
Lead 5	80kg: 1720	242	238	80kg: 134	62	756	25kg: 612	494	
	60kg: 2443	311	317	60kg: 209	117	1398	30kg: 503	407	
Lead 5	80kg: 2193	242	253	80kg: 135	62	1120			
	100kg: 2000	202	214	100kg: 90	29	900			

Note. Distance from center of slider top to center of gravity of object being carried at a guide service life of 10,000 km.

Static loading moment

(Unit: N·m)		
MY	MP	MR
551	552	485

Controller

Controller	Operation method
SR1-X10 RCX221/222 RCX240/340	Programming / I/O point trace / Remote command / Operation using RS-232C communication
TS-X110 TS-X210 RDV-X210-RBR1	I/O point trace / Remote command / Pulse train control

Note. When using the unit vertically, a regeneration unit is required.

F14H

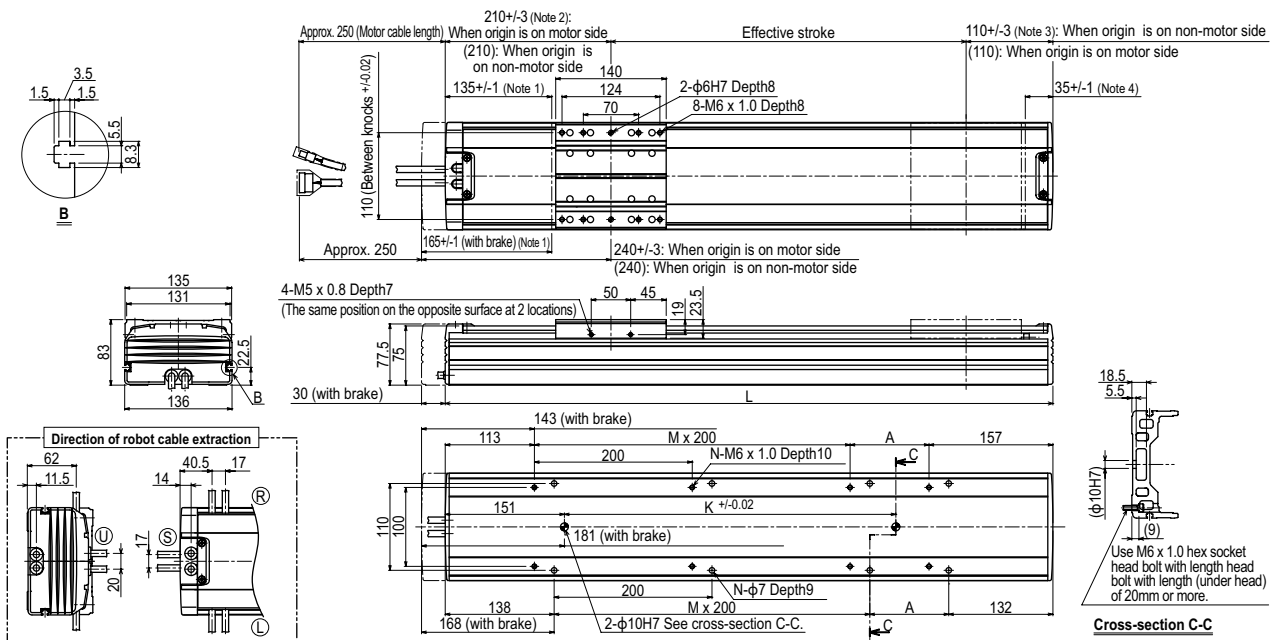

Note 1. Stop positions are determined by the mechanical stoppers at both ends.
 Note 2. 212.5+/-4 when the high lead specification (Lead 30) is used.
 Note 3. 110+/-4 when the high lead specification (Lead 30) is used.
 Note 4. 32.5+/-1 when the high lead specification (Lead 30) is used.
 Note 5. Minimum bend radius of motor cable is R50.
 Note 6. Weight of models with no brake. The weight of brake-attached models is 0.7 kg heavier than the models with no brake shown in the table.
 Note 7. When the stroke is longer than 700mm, resonance of the ball screw may occur depending on the operation conditions (critical speed). In this case, reduce the speed setting on the program by referring to the maximum speeds shown in the table above.
 Note 8. Strokes longer than 1050mm are special order items. Please contact us for speed setting.

Effective stroke	150	200	250	300	350	400	450	500	550	600	650	700	750	800	850	900	950	1000	1050	1100	1150	1200	1250
L	470	520	570	620	670	720	770	820	870	920	970	1020	1070	1120	1170	1220	1270	1320	1370	1420	1470	1520	1570
A	200	50	100	150	200	50	100	150	200	50	100	150	200	50	100	150	200	50	100	150	200	50	100
M	0	1	1	1	1	2	2	2	2	3	3	3	3	4	4	4	4	5	5	5	5	6	6
N	4	6	6	6	6	8	8	8	8	10	10	10	10	12	12	12	12	14	14	14	14	16	16
K	240	240	240	420	420	420	600	600	600	600	600	780	780	960	960	960	960	960	1140	1140	1140	1140	1320
Weight (kg)	7.5	8.2	8.8	9.5	10.1	10.8	11.4	12.1	12.7	13.4	13.9	14.6	15.2	15.9	16.5	17.2	17.8	18.5	19.1	19.8	20.4	21.1	21.7
Lead 30	1800												1440	1170			900		810				
Lead 20		1200											960	780			600		540				
Lead 10			600										480	390			300		270				
Lead 5				300									240	195			150		135				
Speed setting													80%	65%			50%		45%				

Controller

SR1-X ▶ 516

TS-X ▶ 490

RDV-X ▶ 504

GF14XL

● Origin on the non-motor side is selectable

Note. If you need an installation posture other than the horizontal installation, please contact us.

Ordering method

GF14XL - S H - 20

Model	Model S: Straight model	Installation direction H: Horizontal installation	Lead designation	Cable entry location No entry: Standard (S) U: From the top R: From the right L: From the left	Origin position change None: Standard Z: Non-motor side	Frame No entry: Standard Spot facing T: Tapping	Grease type None: Standard GC: Clean	Stroke 750 to 2000 (50mm pitch)	Cable length ^{Note 1} 3L: 3.5m 5L: 5m 10L: 10m 3K/5K/10K (Flexible cable)
-------	-------------------------	---	------------------	--	---	--	--	------------------------------------	--

TSX	Positioner ^{Note 2} TS-X	Driver: Power-supply voltage Power capacity 110: 100V/200W 210: 200V/200W	LCD monitor No entry: None L: With LCD	I/O selection NP: NPN PN: PNP CC: CC-Link DN: DeviceNet™ EP: EtherNet/IP™ PT: PROFINET GW: No I/O board ^{Note 3}	Battery B: With battery (Absolute) N: None (Incremental)
-----	--------------------------------------	--	---	--	--

SR1-X	10	Controller	Driver: Power capacity 10: 200W	Usable for CE No entry: Standard E: CE marking	I/O selection N: NPN P: PNP CC: CC-Link DN: DeviceNet™ PB: PROFIBUS	Battery B: With battery (Absolute) N: None (Incremental)
-------	----	------------	------------------------------------	---	--	--

RDV-X	2	20	RBR1	Driver	Power-supply voltage 2: AC200V	Driver: Power capacity 20: 600W or less	Regenerative unit
-------	---	----	------	--------	-----------------------------------	--	-------------------

Note 1. The robot cable is standard cable (3L/5L/10L), but can be changed to flexible cable. See P.594 for details on robot cable.
Note 2. See P.498 for DIN rail mounting bracket.
Note 3. Select this selection when using the gateway function. For details, see P.60.

- [Cautions after purchase]
- When changing the origin position, contact us since the adjustment is needed.
 - When changing the cable entry location, contact us since necessary parts may vary depending on the cable entry location.
 - Do not install the robot with the horizontal installation specifications in a direction other than the horizontal direction.

Specifications

AC servo motor output (W)	200
Repeatability ^{Note 1} (mm)	+/-0.01
Deceleration mechanism	Ball screw φ15 (Class C7)
Ball screw lead (mm)	20
Maximum speed (mm/sec)	1200
Maximum payload (kg)	45
Rated thrust (N)	170
Stroke (mm)	750 to 2000 (50mm pitch)
Overall length (mm)	Stroke+561
Maximum dimensions of cross section of main unit (mm)	W140×H91.5
Cable length (m)	Standard: 3.5 / Option: 5.10
Linear guide type	4 rows of circular arc grooves × 2 rail
Position detector	Resolvers ^{Note 2}
Resolution (Pulse/rotation)	20480

Allowable overhang ^{Note}

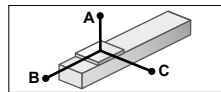

Horizontal installation (Unit: mm)		A	B	C
Lead 20	10kg	3550	1340	1210
	20kg	2075	685	633
	45kg	1280	326	308

Note. Distance from center of slider top to center of gravity of object being carried at a guide service life of 10,000 km.

Note. Service life is calculated for 1000mm stroke models.

Static loading moment

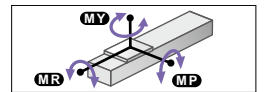

(Unit: N·m)		
MY	MP	MR
551	552	485

Controller

Controller	Operation method
SR1-X10 RCX221/222 RCX240/340	Programming / I/O point trace / Remote command / Operation using RS-232C communication
TS-X110	I/O point trace / Remote command
TS-X210	Remote command
RDV-X220-RBR1	Pulse train control

Note 1. Positioning repeatability in one direction.
Note 2. Position detectors (resolvers) are common to incremental and absolute specifications. If the controller has a backup function then it will be absolute specifications.

GF14XL

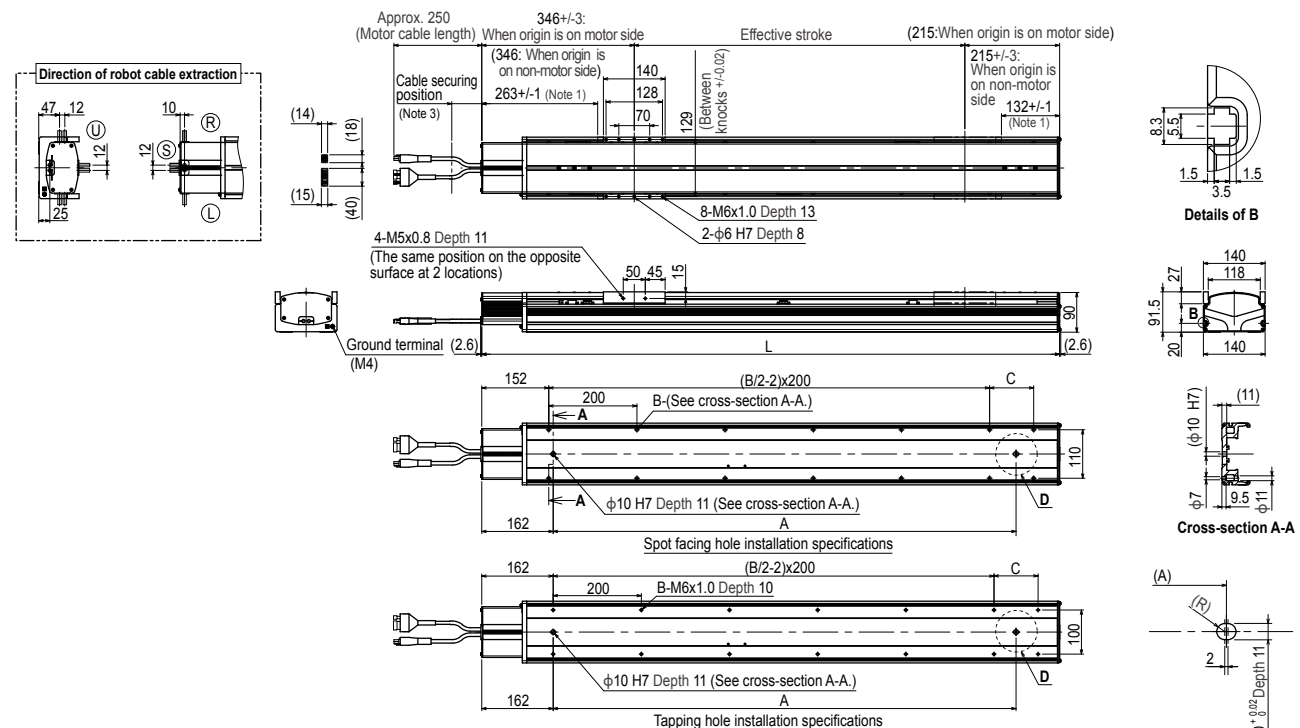

Note 1. Stop positions are determined by the mechanical stoppers at both ends.
Note 2. When changing the return-to-origin direction, the adjustment is needed. (The standard is the origin on the motor side.)
Note 3. Secure the cable with a tie-band 100mm or less from unit's end face to prevent the cable from being subjected to excessive loads.
Note 4. The cable's minimum bend radius is R30.
Note 5. The length under head of the hexagonal socket head bolts (M6 x 1.0) that are used to install the main body with the spot facing hole installation specifications is 20mm or more. It is recommended that the length under head of the hexagonal socket head bolts (M6 x 1.0) that are used to install the main body with the tapping hole installation specifications is the thickness of the installation base + 10mm or less.

Effective stroke	750	800	850	900	950	1000	1050	1100	1150	1200	1250	1300	1350	1400	1450	1500	1550	1600	1650	1700	1750	1800	1850	1900	1950	2000
L	1311	1361	1411	1461	1511	1561	1611	1661	1711	1761	1811	1861	1911	1961	2011	2061	2111	2161	2211	2261	2311	2361	2411	2461	2511	2561
A	1050	1100	1150	1200	1250	1300	1350	1400	1450	1500	1550	1600	1650	1700	1750	1800	1850	1900	1950	2000	2050	2100	2150	2200	2250	2300
B	14	14	14	16	16	16	16	18	18	18	18	20	20	20	20	22	22	22	22	24	24	24	24	26	26	26
C	100	150	200	50	100	150	200	50	100	150	200	50	100	150	200	50	100	150	200	50	100	150	200	50	100	150
Weight (kg)	22.5	23.2	23.8	24.5	25.2	25.9	26.5	27.2	27.9	28.6	29.2	29.9	30.6	31.3	31.9	32.6	33.3	33.9	34.6	35.3	36.0	36.6	37.3	38.0	38.7	39.3

F17

- High lead: Lead 40
- Origin on the non-motor side is selectable

Note. Upper robot cable (U) on models with brakes is a special order item, so please consult our sales office or sales representative for assistance.
(External dimensions: overall length + 20 mm)



Ordering method

F17

Model	Lead designation	Brake	Cable entry location	Origin position change	Grease type	Stroke	Cable length
	40: 40mm 20: 20mm 10: 10mm	No entry: No brakes BK: Brakes provided	No entry: Standard (S) U: From the top R: From the right L: From the left	None: Standard Z: Non-motor side	None: Standard GC: Clean	Lead 20/10: 200 to 1250 (50mm pitch) Lead 40: 200 to 1450 (50mm pitch)	3L: 3.5m 5L: 5m 10L: 10m 3K/5K/10K (Flexible cable)

TSX	220				
Positioner TS-X	Driver: Power-supply voltage Power capacity 220: 200V/400 to 600W	Regenerative unit No entry: None R: With RGT	LCD monitor No entry: None L: With LCD	I/O selection NP: NPN PN: PNP CC: CC-Link DN: DeviceNet™ EP: EtherNet/IP™ PT: PROFINET GW: No I/O board	Battery N: None (Incremental)
SR1-X	20				
Controller	Driver: Power capacity 20: 400 to 600W	Usable for CE No entry: Standard E: CE marking	Regenerative unit No entry: None R: With RG1	I/O selection N: NPN P: PNP CC: CC-Link DN: DeviceNet™ PB: PROFIBUS	Battery B: With battery (Absolute) N: None (Incremental)
RDV-X	2	20			
Driver	Power-supply voltage 2: AC200V	Driver: Power capacity 20: 600W or less	Regenerative unit RBR1 (Horizontal) RBR2 (Vertical)		

- Note 1. The model with a lead of 40mm cannot select specifications with brake (vertical specifications).
Note 2. Upper robot cable (U) on models equipped with brake is a special-order item.
Note 3. The robot cable is standard cable (3L/5L/10L), but can be changed to flexible cable. See P.594 for details on robot cable.
Note 4. See P.498 for DIN rail mounting bracket.
Note 5. The robot with the high lead specifications (lead 40) needs a regenerative unit.
Note 6. Select this selection when using the gateway function. For details, see P.60.

Specifications

AC servo motor output (W)	400
Repeatability (mm)	+/-0.01
Deceleration mechanism	Ball screw (Class C7)
Ball screw lead (mm)	40 20 10
Maximum speed (mm/sec)	2400 1000 (1200) 600
Maximum payload (kg)	Horizontal 40 80 120 Vertical - 15 35
Rated thrust (N)	169 339 678
Stroke (mm)	200 to 1450 (50mm pitch)
Overall length (mm)	Horizontal Stroke+375 Stroke+365 Vertical - Stroke+395
Maximum dimensions of cross section of main unit (mm)	W168 x H100
Cable length (m)	Standard: 3.5 / Option: 5.10
Linear guide type	4 rows of circular arc grooves x 2 rail
Position detector	Resolvers
Resolution (Pulse/rotation)	16384

- Note 1. Repeatability for single oscillation.
Note 2. When the stroke exceeds 800mm, although depending on the moving range, the ball screw may resonate (critical speed). In that case, make adjustment to lower the speed on the program using the maximum speed given in the below table as a guide.
Note 3. To operate the unit at a speed exceeding 1,000mm/sec. (Max. speed), a regeneration unit RG1 is required.
Note 4. Longer than 1250mm stroke can be handled by the high lead specification (Lead 40) only.
Note 5. Position detectors (resolvers) are common to incremental and absolute specifications. If the controller has a backup function then it will be absolute specifications.

Allowable overhang

	Horizontal installation (Unit: mm)			Wall installation (Unit: mm)			Vertical installation (Unit: mm)		
	A	B	C	A	B	C	A	C	
Lead 40	10kg 3540	20kg 2753	30kg 1999	10kg 2022	20kg 2670	30kg 3501	5kg 3000	3000	
Lead 20	10kg 2541	20kg 1357	30kg 1181	10kg 1202	20kg 1283	30kg 2483	10kg 2447	2447	
Lead 10	10kg 2639	20kg 661	30kg 736	10kg 752	20kg 587	30kg 2516	15kg 1650	1650	
Lead 10	10kg 2647	20kg 894	30kg 989	10kg 987	20kg 820	30kg 2578	15kg 1782	1782	
Lead 10	10kg 1770	20kg 521	30kg 588	10kg 574	20kg 447	30kg 1685	25kg 1054	1054	
Lead 10	10kg 1391	20kg 312	30kg 362	10kg 342	20kg 237	30kg 1263	35kg 742	742	
Lead 10	10kg 2443	20kg 430	30kg 572	10kg 535	20kg 355	30kg 2443			
Lead 10	10kg 2000	20kg 243	30kg 326	10kg 283	20kg 169	30kg 2000			
Lead 10	10kg 1841	20kg 197	30kg 264	10kg 220	20kg 123	30kg 1841			

Note. Distance from center of slider top to center of gravity of object being carried at a guide service life of 10,000 km.

Static loading moment

	MY	MP	MR
(Unit: N·m)	1032	1034	908

Controller

Controller	Operation method
SR1-X20	Programming / I/O point trace
RCX221/222	Remote command / Operation using RS-232C communication
RCX240/340	
TS-X220	I/O point trace / Remote command
RDV-X220-RBR1 (Horizontal)	
RDV-X220-RBR2 (Vertical)	

Pulse train control

Note. When using the vertical model, if the unit is operated at such speed exceeding the maximum speed of 1,000mm/sec., and if it has a high lead (40), a regeneration unit is required.

F17

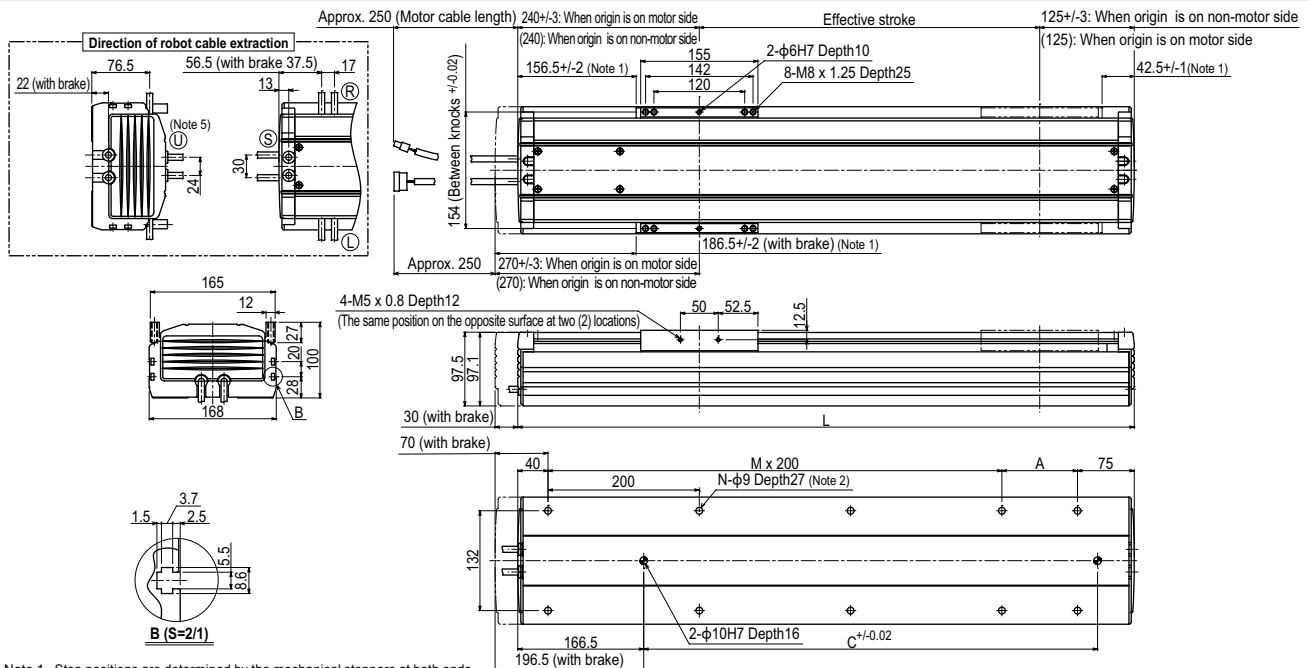

- Note 1. Stop positions are determined by the mechanical stoppers at both ends.
Note 2. When installing the robot, do not use washers inside the robot body.
Note 3. Minimum bend radius of motor cable is R50.
Note 4. Weight of models with no brake. The weight of brake-attached models is 1.2 kg heavier than the models with no brake shown in the table.
Note 5. Make a separate consultation with us regarding robot cable (brake specifications) U extraction. (External dimensions: overall length + 20 mm)
Note 6. When the stroke is longer than 800mm, resonance of the ball screw may occur depending on the operation conditions (critical speed). In this case, reduce the speed setting on the program by referring to the maximum speeds shown in the table above.
Note 7. To operate the unit at a speed exceeding 1,000mm/sec. (Max. speed), a regeneration unit RG1 is required.

Effective stroke	200	250	300	350	400	450	500	550	600	650	700	800	850	900	950	1000	1050	1100	1150	1200	1250			
L	565	615	665	715	765	815	865	915	965	1015	1065	1115	1165	1215	1265	1315	1365	1415	1465	1515	1565	1615		
A	50	100	150	200	50	100	150	200	50	100	150	200	50	100	150	200	50	100	150	200	50	100		
M	2	2	2	2	3	3	3	3	4	4	4	4	5	5	5	5	6	6	6	6	7	7		
N	8	8	8	8	10	10	10	10	12	12	12	12	14	14	14	16	16	16	16	16	18	18		
C	240	240	420	420	420	600	600	600	600	780	780	780	780	960	960	960	1140	1140	1140	1140	1320	1320		
Weight (kg)	14.5	15.3	16.2	17.0	17.8	18.6	19.5	20.3	21.1	21.9	22.8	23.6	24.4	25.2	26.1	26.9	27.7	28.5	29.4	30.2	31.0	31.8		
Maximum speed (mm/sec)	1000(1200) (Note 7)												960	840	720	600	480	420	360	300	240	200	180	
Speed setting	600												80%	70%	60%	50%	40%							

Controller

SR1-X ▶ 516 TS-X ▶ 490 RDV-X ▶ 504

- Articulated robots
YA
- Linear conveyor modules
LCM100
- Compact single-axis robots
TRANSEVO
- Single-axis robots
FLIP-X
- Linear motor single-axis robots
PHASER
- Cartesian robots
XY-X
- SCARA robots
YK-X
- Pick & place robots
YP-X
- CLEAN CONTROLLER INFORMATION
- T type
- F type
- GF type
- N type
- B/R type

F17 High lead type: Lead 40

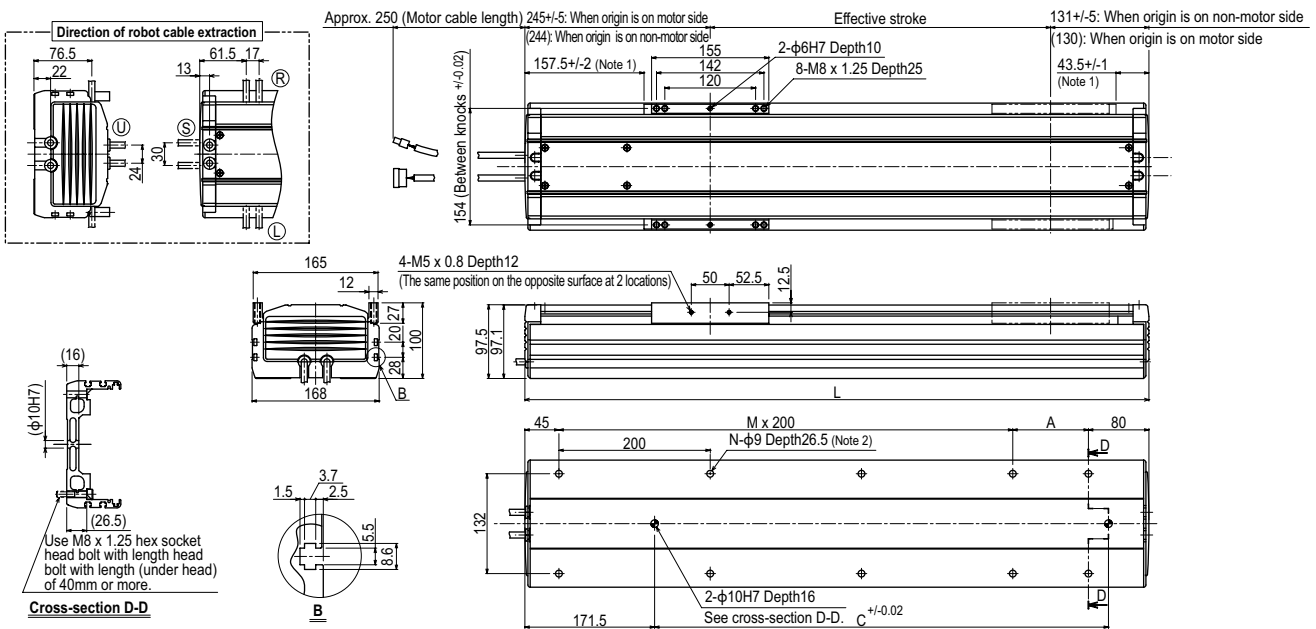

Note 1. Stop positions are determined by the mechanical stoppers at both ends.
Note 2. When installing the robot, do not use washers inside the robot body.

Note 3. Minimum bend radius of motor cable is R50.

Effective stroke	200	250	300	350	400	450	500	550	600	650	700	750	800	850	900	950	1000	1050	1100	1150	1200	1250	1300	1350	1400	1450		
L	575	625	675	725	775	825	875	925	975	1025	1075	1125	1175	1225	1275	1325	1375	1425	1475	1525	1575	1625	1675	1725	1775	1825		
A	50	100	150	200	50	100	150	200	50	100	150	200	50	100	150	200	50	100	150	200	50	100	150	200	50	100		
M	2	2	2	2	3	3	3	3	4	4	4	4	5	5	5	5	6	6	6	6	7	7	7	7	8	8		
N	8	8	8	8	10	10	10	10	12	12	12	12	14	14	14	14	16	16	16	16	18	18	18	18	20	20		
C	240	240	420	420	420	600	600	600	600	780	780	780	780	960	960	960	960	1140	1140	1140	1140	1320	1320	1320	1320	1320		
Weight (kg)	14.7	15.5	16.4	17.2	18.0	18.8	19.7	20.5	21.3	22.1	23.0	23.8	24.6	25.4	26.3	27.1	27.9	28.7	29.6	30.4	31.2	32.0	32.8	33.6	34.4	35.2		
Maximum speed ^{Note 4} (mm/sec)	Lead 40 2400														1920		1680		1440		1200		960		840		720	
Speed setting	-														80%		70%		60%		50%		40%		35%		30%	

Note 4. When the stroke is longer than 800mm, resonance of the ball screw may occur depending on the operation conditions (critical speed). In this case, reduce the speed setting on the program by referring to the maximum speeds shown in the table above.

F17L

● Origin on the non-motor side is selectable

Note. Upper robot cable (U) on models with brakes is a special order item, so please consult our sales office or sales representative for assistance. (External dimensions: overall length + 20 mm)

Ordering method

F17L-50

Model	Lead designation	Brake	Cable entry location	Origin position change	Grease type	Stroke	Cable length ^{Note 1}
		No entry: No brakes BK: Brakes provided	No entry: Standard (S) U: From the top ^{Note 1} R: From the right L: From the left	None: Standard Z: Non-motor side	None: Standard GC: Clean	1100 to 2050 (50mm pitch)	3L: 3.5m 5L: 5m 10L: 10m 3K/5K/10K (Flexible cable)

TSX	220	R	I/O selection	Battery	
Positioner ^{Note 1} TS-X	Driver: Power supply voltage / Power capacity ^{Note 4} 220: 200V/400 to 600W	Regenerative unit R: With RGT	LCD monitor No entry: None L: With LCD	N: NPN P: PNP CC: CC-Link DN: DeviceNet™ EP: EtherNet/IP™ PT: PROFINET GW: No I/O board ^{Note 5}	B: With battery (Absolute) N: None (Incremental)
SR1-X	20	R	I/O selection	Battery	
Controller	Driver: Power capacity ^{Note 4} 20: 400 to 600W	Usable for CE No entry: Standard E: CE marking	Regenerative unit R: With RGT1	N: NPN P: PNP CC: CC-Link DN: DeviceNet™ PB: PROFIBUS	B: With battery (Absolute) N: None (Incremental)
RDV-X	2	20	Regenerative unit	Battery	
Driver	Power supply voltage 2: AC200V	Driver: Power capacity ^{Note 4} 20: 600W or less	RBR1 (Horizontal) RBR2 (Vertical)		

- Note 1. Upper robot cable (U) on models equipped with brake is a special-order item.
 Note 2. The robot cable is standard cable (3L/5L/10L), but can be changed to flexible cable. See P.594 for details on robot cable.
 Note 3. See P.498 for DIN rail mounting bracket.
 Note 4. Acceleration / deceleration is different depending the Positioner or Controller or Driver.
 Note 5. Select this selection when using the gateway function. For details, see P.60.

Specifications

AC servo motor output (W)	600
Repeatability ^{Note 1} (mm)	+/-0.02
Deceleration mechanism	Ball screw (Class C10)
Ball screw lead (mm)	50
Maximum speed ^{Note 2} (mm/sec)	2200
Maximum payload (kg)	Horizontal: 50 Vertical: 10
Rated thrust (N)	204
Stroke (mm)	1100 to 2050 (50mm pitch)
Overall length (mm)	Horizontal: Stroke+475 Vertical: Stroke+505
Maximum dimensions of cross section of main unit (mm)	W168 × H100
Cable length (m)	Standard: 3.5 / Option: 5.10
Linear guide type	4 rows of circular arc grooves × 2 rail
Position detector	Resolvers ^{Note 3}
Resolution (Pulse/rotation)	16384

- Note 1. Positioning repeatability in one direction.
 Note 2. When the stroke is longer than 1200mm, resonance of the ball screw may occur depending on the operation conditions (critical speed). In this case, reduce the speed setting on the program by referring to the maximum speeds shown in the table below.
 Note 3. Position detectors (resolvers) are common to incremental and absolute specifications. If the controller has a backup function then it will be absolute specifications.

Allowable overhang ^{Note}

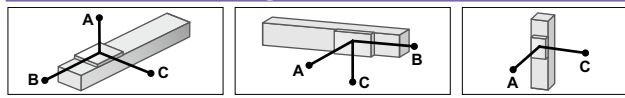

Lead 50	Horizontal installation (Unit: mm)			Wall installation (Unit: mm)			Vertical installation (Unit: mm)		
	A	B	C	A	B	C	A	B	C
10kg	4000	2755	2608	2720	2681	4000	2kg	1200	1200
30kg	3045	895	1175	1185	821	3045	5kg	3000	3000
50kg	2602	523	715	680	449	2602	10kg	2650	2650

Note. Distance from center of slider top to center of gravity of object being carried at a guide service life of 10,000 km.

Static loading moment

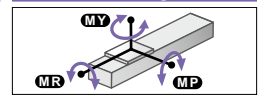

(Unit: N·m)		
MY	MP	MR
1032	1034	908

Controller

Controller	Operation method
SR1-X20-R RCX221/222 RCX240/340	Programming / I/O point trace / Remote command / Operation using RS-232C communication
TS-X220-R RDV-X220-RBR1 (Horizontal) RDV-X220-RBR2 (Vertical)	I/O point trace / Remote command Pulse train control

F17L

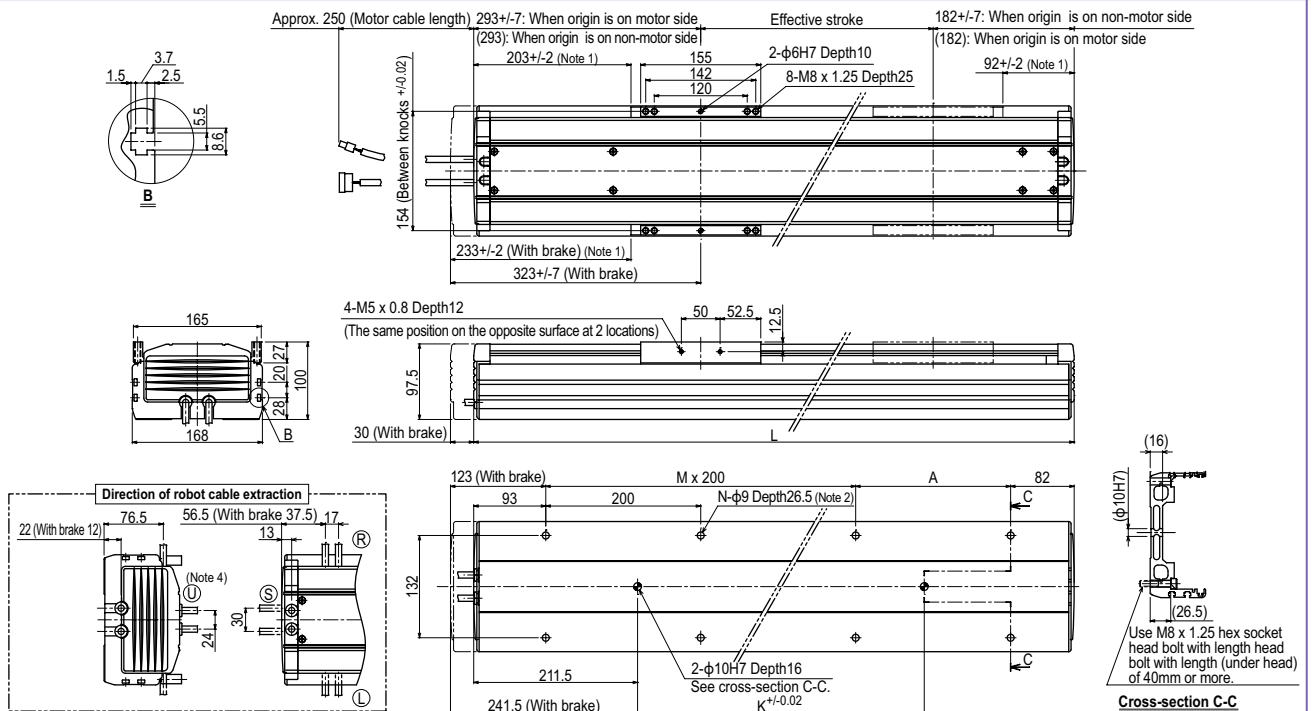

- Note 1. Stop positions are determined by the mechanical stoppers at both ends.
 Note 2. It is not allowed to use a counter bore washer, etc. when installing the main unit.
 Note 3. This is the weight of the model without a brake. The weight of the model equipped with a brake is 1.2kg heavier than this value.
 Note 4. Make a separate consultation with us regarding robot cable (brake specifications) U extraction. (External dimensions: overall length + 20 mm)

Effective stroke	1100	1150	1200	1250	1300	1350	1400	1450	1500	1550	1600	1650	1700	1750	1800	1850	1900	1950	2000	2050
L	1575	1625	1675	1725	1775	1825	1875	1925	1975	2025	2075	2125	2175	2225	2275	2325	2375	2425	2475	2525
A	200	50	100	150	200	50	100	150	200	50	100	150	200	50	100	150	200	50	100	150
M	6	7	7	7	7	7	7	7	7	7	7	7	7	7	7	7	7	7	7	7
N	16	18	18	18	18	20	20	20	20	22	22	22	22	24	24	24	24	26	26	26
K	1140	1140	1320	1320	1320	1320	1320	1320	1320	1320	1320	1320	1320	1320	1320	1320	1320	1320	1320	1320
Weight (kg) ^{Note 3}	34.1	34.9	35.8	36.7	37.6	38.4	39.3	40.2	41.1	42	42.9	43.8	44.7	45.6	46.5	47.3	48.2	49.1	50	50.9
Maximum speed ^{Note 5}	2200				1900				1500				1200				900		800	
(mm/sec)	Speed setting				86%				68%				54%				40%		36%	

Note 5. When the stroke exceeds 1200mm, although depending on the moving range, the ball screw may resonate (critical speed). In that case, make adjustment to lower the speed on the program using the maximum speed given in the above table as a guide.

Controller

SR1-X ▶ 516 TS-X ▶ 490 RDV-X ▶ 504

GF17XL

Origin on the non-motor side is selectable

Note. If you need an installation posture other than the horizontal installation, please contact us.

Ordering method

GF17XL - S H - 20

Model	Model	Installation direction	Lead designation	Cable entry location	Origin position change	Frame	Grease type	Stroke	Cable length
S: Straight model	H: Horizontal installation	No entry: Standard (S) U: From the top R: From the right L: From the left	No entry: Standard Z: Non-motor side	No entry: Standard (Spot facing) T: Tapping	None: Standard GC: Clean	850 to 2500 (50mm pitch)	3L: 3.5m 5L: 5m 10L: 10m 3K/5K/10K (Flexible cable)		

TSX Positioner 220 Driver: Power-supply voltage / Power capacity 220: 200V/400 to 600W	Regenerative unit No entry: None R: With RGT	LCD monitor No entry: None L: With LCD	I/O selection N: NPN P: PNP CC: CC-Link DN: DeviceNet™ EP: EtherNet/IP™ PT: PROFINET GW: No I/O board	Battery B: With battery (Absolute) N: None (Incremental)
SR1-X Controller 20 Driver: Power capacity 20: 400 to 600W	Usable for CE marking No entry: Standard E: CE marking R: With RGT	Regenerative unit No entry: None R: With RGT	I/O selection N: NPN P: PNP CC: CC-Link DN: DeviceNet™ EP: EtherNet/IP™ PB: PROFIBUS	Battery B: With battery (Absolute) N: None (Incremental)
RDV-X Driver 2 Power-supply voltage 2: AC200V	20 Driver: Power capacity 20: 600W or less	RBR1 Regenerative unit		

Note 1. The robot cable is standard cable (3L/5L/10L), but can be changed to flexible cable. See P.594 for details on robot cable.
 Note 2. See P.498 for DIN rail mounting bracket.
 Note 3. Select this selection when using the gateway function. For details, see P.60.
 Note 4. When operating the robot at a speed that is a maximum speed of 750 mm/sec or less, the regenerative unit is not needed.

- [Cautions after purchase]
- When changing the origin position, contact us since the adjustment is needed.
 - When changing the cable entry location, contact us since necessary parts may vary depending on the cable entry location.
 - Do not install the robot with the horizontal installation specifications in a direction other than the horizontal direction.

Specifications

AC servo motor output (W)	400
Repeatability ^{Note 1} (mm)	+/-0.01
Deceleration mechanism	Ball screw φ20 (Class C7)
Ball screw lead (mm)	20
Maximum speed (mm/sec)	1200 ^{Note 2}
Maximum payload (kg)	90
Rated thrust (N)	339
Stroke (mm)	850 to 2500 (50mm pitch)
Overall length (mm)	Stroke+686
Maximum dimensions of cross section of main unit (mm)	W168×H105.5
Cable length (m)	Standard: 3.5 / Option: 5.10
Linear guide type	4 rows of circular arc grooves × 2 rail
Position detector	Resolvers ^{Note 3}
Resolution (Pulse/rotation)	20480

Allowable overhang^{Note}

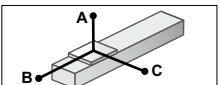

Horizontal installation (Unit: mm)	A	B	C	
	30kg	4050	1090	1405
Lead 20	50kg	2755	650	835
	90kg	1610	345	450

Note. Distance from center of slider top to center of gravity of object being carried at a guide service life of 10,000 km.
 Note. Service life is calculated for 1000mm stroke models.

Static loading moment

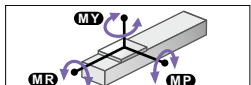

(Unit: N·m)		
MY	MP	MR
1032	1034	908

Controller

Controller	Operation method
SR1-X20 ^{Note} RCX221/222 RCX240/340	Programming / I/O point trace / Remote command / Operation using RS-232C communication
TS-X220	I/O point trace / Remote command
RDV-X220-RBR1	Pulse train control

Note. To operate the unit at a speed exceeding 750 mm/sec. (Max. speed), a regeneration unit is required.

GF17XL

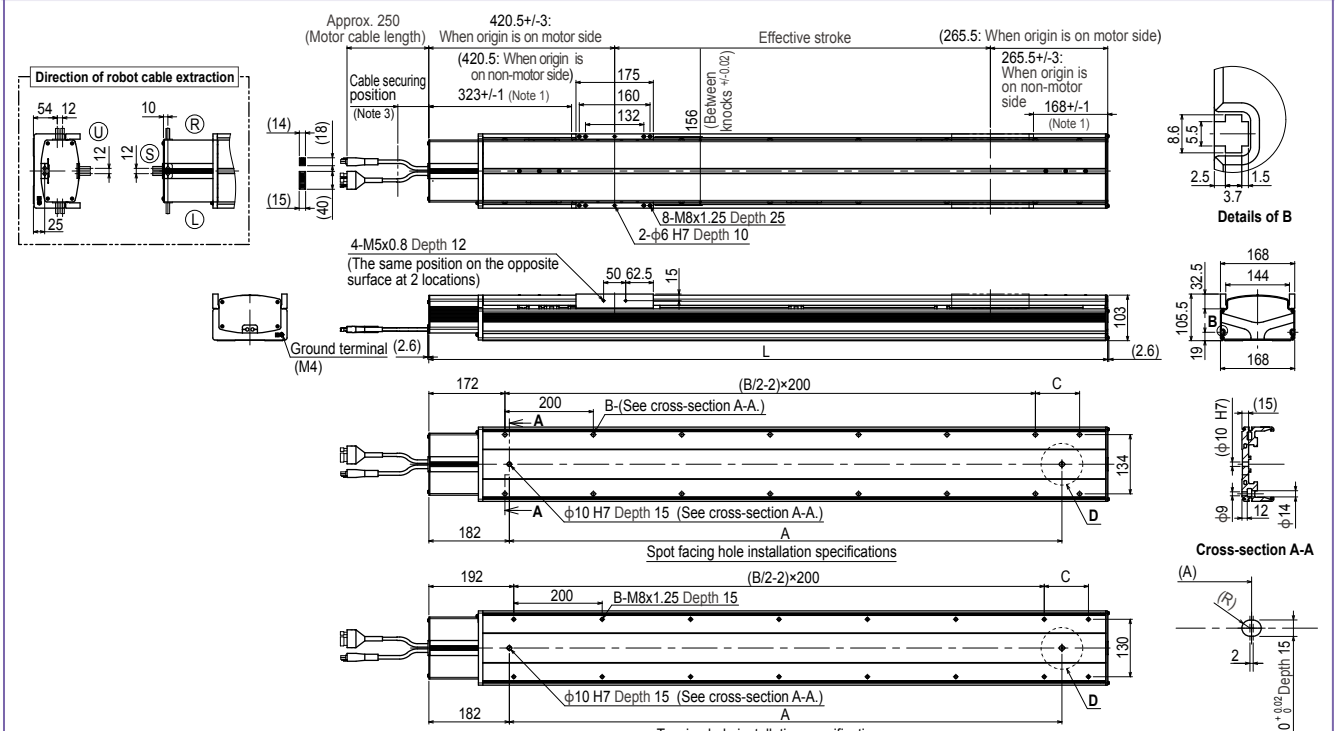

Note 1. Stop positions are determined by the mechanical stoppers at both ends.
 Note 2. When changing the return-to-origin direction, the adjustment is needed. (The standard is the origin on the motor side.)
 Note 3. Secure the cable with a tie-band 100mm or less from unit's end face to prevent the cable from being subjected to excessive loads.
 Note 4. The cable's minimum bend radius is R30.
 Note 5. The length under head of the hexagonal socket head bolts (M8 x 1.25) that are used to install the main body with the spot facing hole installation specifications is 45 mm or more. It is recommended that the length under head of the hexagonal socket head bolts (M8 x 1.25) that are used to install the main body with the tapping hole installation specifications is the thickness of the installation base + 15 mm or less.

Effective stroke	850	900	950	1000	1050	1100	1150	1200	1250	1300	1350	1400	1450	1500	1550	1600	1650	1700	1750	1800	1850	1900	1950	2000	2050	2100	2150	2200	2250	2300	2350	2400	2450	2500
L	1536	1586	1636	1686	1736	1786	1836	1886	1936	1986	2036	2086	2136	2186	2236	2286	2336	2386	2436	2486	2536	2586	2636	2686	2736	2786	2836	2886	2936	2986	3036	3086	3136	3186
A	1250	1300	1350	1400	1450	1500	1550	1600	1650	1700	1750	1800	1850	1900	1950	2000	2050	2100	2150	2200	2250	2300	2350	2400	2450	2500	2550	2600	2650	2700	2750	2800	2850	2900
B	16	16	16	18	18	18	18	20	20	20	20	22	22	22	22	24	24	24	24	26	26	26	26	28	28	28	28	30	30	30	30	32	32	32
C	100	150	200	50	100	150	200	50	100	150	200	50	100	150	200	50	100	150	200	50	100	150	200	50	100	150	200	50	100	150	200	50	100	150
Weight (kg)	37.4	38.4	39.4	40.3	41.3	42.3	43.2	44.2	45.2	46.1	47.1	48.1	49.0	50.0	51.0	51.9	52.9	53.9	54.8	55.8	56.8	57.7	58.7	59.7	60.6	61.6	62.6	63.5	64.5	65.5	66.4	67.4	68.4	69.3

F20

- High lead: Lead 40
- Origin on the non-motor side is selectable



Note. Upper robot cable (U) on models with brakes is a special order item, so please consult our sales office or sales representative for assistance. (External dimensions: overall length + 20 mm)

Ordering method

F20

Model	Lead designation	Brake	Cable entry location	Origin position change	Grease type	Stroke	Cable length
	40: 40mm 20: 20mm 10: 10mm	No entry: BK: Brakes provided	No entry: Standard (S) U: From the top R: From the right L: From the left	None: Standard Z: Non-motor side	None: Standard GC: Clean	Lead 20-10: 200 to 1250 (50mm pitch) Lead 40: 200 to 1450 (50mm pitch)	3L: 3.5m 5L: 5m 10L: 10m 3K/5K/10K (Flexible cable)

- Note 1. The model with a lead of 40mm cannot select specifications with brake (vertical specifications).
 Note 2. Upper robot cable (U) on models equipped with brake is a special-order item.
 Note 3. The robot cable is standard cable (3L/5L/10L), but can be changed to flexible cable. See P.594 for details on robot cable.
 Note 4. See P.498 for DIN rail mounting bracket.
 Note 5. Acceleration / deceleration is different depending the Positioner or Controller or Driver.
 Note 6. The robot with the high lead specifications (lead 40) needs a regenerative unit.
 Note 7. Select this selection when using the gateway function. For details, see P.60.

TSX	220			
Positioner TS-X	Driver: Power-supply voltage Power capacity 220: 200V/400 to 600W	Regenerative unit No entry: None R: With RGT	LCD monitor No entry: None L: With LCD	I/O selection NP: NPN PN: PNP CC: CC-Link DN: DeviceNet™ EP: EtherNet/IP™ PT: PROFINET GW: No I/O board
Battery				Battery B: With battery (Absolute) N: None (Incremental)
SR1-X	20			
Controller	Driver: Power capacity 20: 400 to 600W	Usable for CE No entry: Standard E: CE marking	Regenerative unit No entry: None R: With RG1	I/O selection N: NPN P: PNP CC: CC-Link DN: DeviceNet™ PB: PROFIBUS
Battery				Battery B: With battery (Absolute) N: None (Incremental)
RDV-X	2	20		
Driver	Power-supply voltage 2: AC200V	Driver: Power capacity 20: 600W or less		Regenerative unit RBR1 (Horizontal) RBR2 (Vertical)

Specifications

AC servo motor output (W)	600		
Repeatability (mm)	±0.01		
Deceleration mechanism	Ball screw (Class C7)		
Ball screw lead (mm)	40	20	10
Maximum speed (mm/sec)	2400	1000 (1200)	600
Maximum payload (kg)	Horizontal	Vertical	
	60	120	
Rated thrust (N)	255	510	1020
Stroke (mm)	200 to 1450 (50mm pitch)		
Overall length (mm)	Horizontal	Stroke+427	Stroke+417
	Vertical	-	Stroke+447
Maximum dimensions of cross section of main unit (mm)	W202 × H115		
Cable length (m)	Standard: 3.5 / Option: 5.10		
Linear guide type	4 rows of circular arc grooves × 2 rail		
Position detector	Resolvers		
Resolution (Pulse/rotation)	16384		

- Note 1. Positioning repeatability in one direction.
 Note 2. When the stroke is longer than 800mm, resonance of the ball screw may occur depending on the operation conditions (critical speed). In this case, reduce the speed setting on the program by referring to the maximum speeds shown in the table below.
 Note 3. To operate the unit at a speed exceeding 1,000mm/sec. (Max. speed), a regeneration unit RG1 is required.
 Note 4. Longer than 1250mm stroke can be handled by the high lead specification (Lead 40) only.
 Note 5. Position detectors (resolvers) are common to incremental and absolute specifications. If the controller has a backup function then it will be absolute specifications.

Allowable overhang

Horizontal installation (Unit: mm)	Horizontal installation (Unit: mm)				Wall installation (Unit: mm)				Vertical installation (Unit: mm)				
	A	B	C		A	B	C		A	C			
Lead 40	10kg	4000	4000	3450	10kg	3571	4000	4000	15kg	2635	2635		
	20kg	3397	2235	2073	20kg	2118	2164	3397	20kg	2000	2000		
	60kg	2443	718	977	60kg	1000	648	2443	25kg	1621	1621		
	50kg	2602	869	1083	50kg	1097	799	2602	20kg	2188	2188		
	80kg	2193	528	703	80kg	708	458	2193	30kg	1446	1446		
Lead 20	120kg	1841	339	505	120kg	468	268	1841	45kg	951	951		

Note. Distance from center of slider top to center of gravity of object being carried at a guide service life of 10,000 km.

Static loading moment

Static loading moment (Unit: N·m)		
MY	MP	MR
1196	1199	1052

Controller

Controller	Operation method
SR1-X20 RCX221/222 RCX240/340	Programming / I/O point trace / Remote command / Operation using RS-232C communication
TS-X220	I/O point trace / Remote command
RDV-X220-RBR1 (Horizontal) RDV-X220-RBR2 (Vertical)	Pulse train control

Note. When using the vertical model, if the unit is operated at such speed exceeding the maximum speed of 1,000mm/sec., and if it has a high lead (40), a regeneration unit is required.

F20

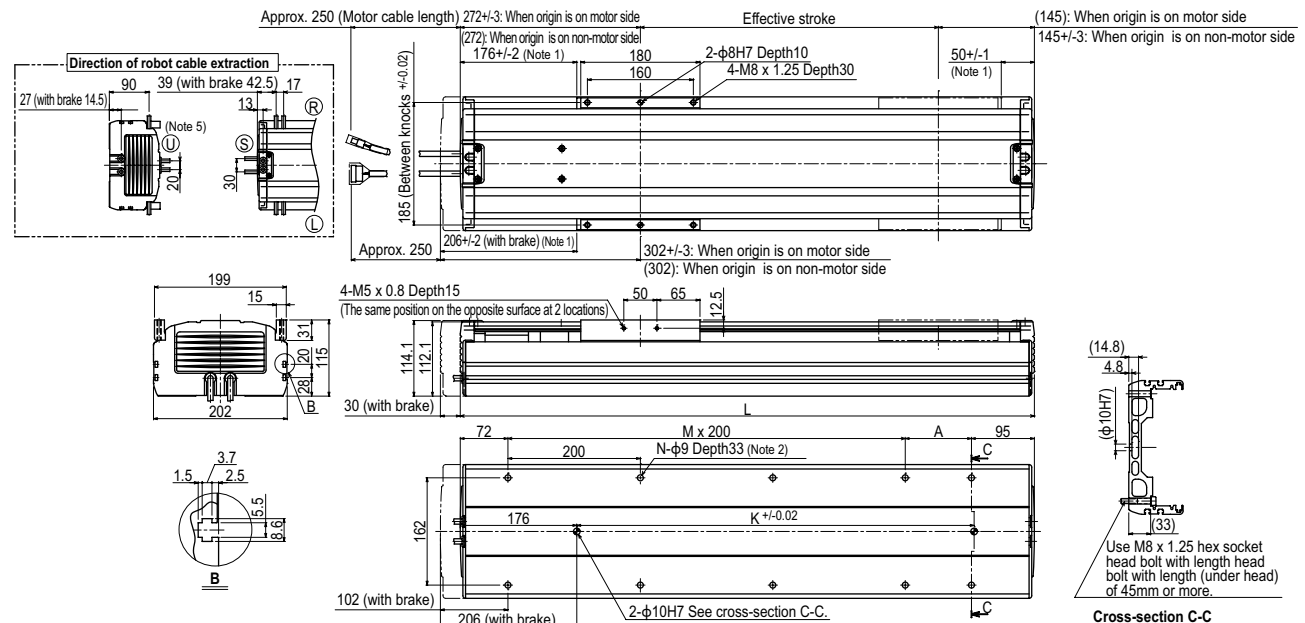

- Note 1. Stop positions are determined by the mechanical stoppers at both ends.
 Note 2. When installing the robot, do not use washers inside the robot body.
 Note 3. Minimum bend radius of motor cable is R50.
 Note 4. Weight of models with no brake. The weight of brake-attached models is 1.5 kg heavier than the models with no brake shown in the table.
 Note 5. Make a separate consultation with us regarding robot cable (brake specifications) U extraction. (External dimensions: overall length + 20 mm)

Effective stroke	200	250	300	350	400	450	500	550	600	650	700	750	800	850	900	950	1000	1050	1100	1150	1200	1250
L	617	667	717	767	817	867	917	967	1017	1067	1117	1167	1217	1267	1317	1367	1417	1467	1517	1567	1617	1667
A	50	100	150	200	50	100	150	200	50	100	150	200	50	100	150	200	50	100	150	200	50	100
M	2	2	2	2	3	3	3	3	4	4	4	5	5	5	5	6	6	6	6	6	7	7
N	8	8	8	8	10	10	10	10	12	12	12	14	14	14	14	16	16	16	16	16	18	18
K	420	420	420	420	600	600	600	600	780	780	780	780	960	960	960	960	1140	1140	1140	1320	1320	1320
Weight (kg)	21.0	22.0	22.9	23.8	24.8	25.7	26.6	27.5	28.5	29.4	30.3	31.2	32.1	33.0	34.0	34.9	35.8	36.7	37.7	38.6	39.5	40.4
Maximum speed (mm/sec)	1000 (1200)										960	840	720	600	480							
Speed setting	-										80%	70%	60%	50%	40%							

- Note 6. When the stroke exceeds 800mm, although depending on the moving range, the ball screw may resonate (critical speed). In that case, make adjustment to lower the speed on the program using the maximum speed given in the above table as a guide.
 Note 7. To operate the unit at a speed exceeding 1,000mm/sec. a regeneration unit RG1 is required.

- Articulated robots
YA
- Linear conveyor modules
LCM100
- Compact single-axis robots
TRANSEVO
- Single-axis robots
FLIP-X
- Linear motor single-axis robots
PHASER
- Cartesian robots
XY-X
- SCARA robots
YK-X
- Pick & place robots
YP-X
- CLEAN
- CONTROLLER INFORMATION
- T type
- F type
- GF type
- N type
- B/R type

F20 High lead type: Lead 40

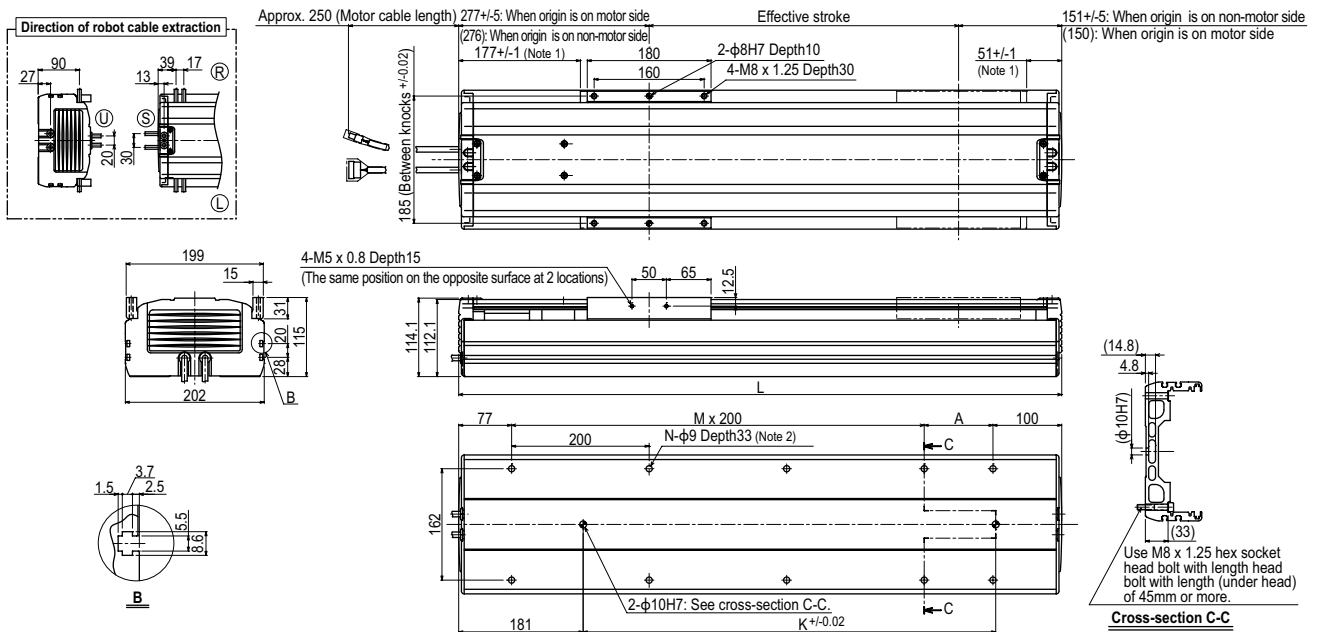

Note 1. Stop positions are determined by the mechanical stoppers at both ends.

Note 3. Minimum bend radius of motor cable is R50.

Note 2. When installing the robot, do not use washers inside the robot body.

Effective stroke	200	250	300	350	400	450	500	550	600	650	700	750	800	850	900	950	1000	1050	1100	1150	1200	1250	1300	1350	1400	1450
L	627	677	727	777	827	877	927	977	1027	1077	1127	1177	1227	1277	1327	1377	1427	1477	1527	1577	1627	1677	1727	1777	1827	1877
A	50	100	150	200	50	100	150	200	50	100	150	200	50	100	150	200	50	100	150	200	50	100	150	200	50	100
M	2	2	2	2	3	3	3	3	4	4	4	4	5	5	5	6	6	6	6	7	7	7	7	7	8	8
N	8	8	8	8	10	10	10	10	12	12	12	12	14	14	14	14	16	16	16	16	18	18	18	18	20	20
K	420	420	420	420	600	600	600	600	780	780	780	780	960	960	960	960	1140	1140	1140	1320	1320	1320	1320	1320	1320	1320
Weight (kg)	21.2	22.2	23.1	24.0	25.0	25.9	26.8	27.7	28.7	29.6	30.5	31.4	32.3	33.2	34.2	35.1	36.0	36.9	37.9	38.8	39.7	40.6	41.5	42.4	43.3	44.2
Maximum speed ^{Note 4} (mm/sec)	Lead 40		2400																							
Speed setting			-																							
			80%																							
			70%																							
			60%																							
			50%																							
			40%																							
			35%																							
			30%																							

Note 4. When the stroke is longer than 800mm, resonance of the ball screw may occur depending on the operation conditions (critical speed). In this case, reduce the speed setting on the program by referring to the maximum speeds shown in the table above.

Note 5. Longer than 1250mm stroke can be handled by the high lead specification (Lead 40) only.

F20N



Ordering method

F20N - 20					
Model	Lead designation	Origin position change	Grease type	Stroke	Cable length ^{Note 1}
		None: Standard 2: Non-motor side	None: Standard GC: Clean	1150 to 2050 (100mm pitch)	3L: 3.5m 5L: 5m 10L: 10m 3K/5K/10K (Flexible cable)

TSX	220				
Positioner ^{Note 2}	Driver: Power-supply voltage / Power capacity	Regenerative unit	LCD monitor	I/O selection	Battery
TS-X	220: 200V/400 to 600W	No entry: None R: With RGT	No entry: None L: With LCD	N: NPN PN: PNP CC: CC-Link DN: DeviceNet™ EP: EtherNet/IP™ PT: PROFINET GW: No I/O board ^{Note 3}	B: With battery (Absolute) N: None (Incremental)
SR1-X	20				
Controller	Driver: Power capacity	Usable for CE	Regenerative unit	I/O selection	Battery
	20: 400 to 600W	No entry: Standard E: CE marking	No entry: None R: With RGT	N: NPN P: PNP CC: CC-Link DN: DeviceNet™ PB: PROFIBUS	B: With battery (Absolute) N: None (Incremental)
RDV-X	2	20		RBR1	
Driver	Power-supply voltage	Driver: Power capacity		Regenerative unit	
	2: AC200V	20: 600W or less			

Note 1. The robot cable is standard cable (3L/5L/10L), but can be changed to flexible cable. See P.594 for details on robot cable.
 Note 2. See P.498 for DIN rail mounting bracket.
 Note 3. Select this selection when using the gateway function. For details, see P.60.

Specifications

AC servo motor output (W)	400
Repeatability ^{Note 1} (mm)	+/-0.04
Deceleration mechanism	Ball screw (Class C10)
Ball screw lead (mm)	20
Maximum speed (mm/sec)	1000 (1200 ^{Note 2})
Maximum payload (kg)	80
Rated thrust (N)	339
Stroke (mm)	1150 to 2050 (100mm pitch)
Overall length (mm)	Stroke+420
Maximum dimensions of cross section of main unit (mm)	W202 x H120
Cable length (m)	Standard: 3.5 / Option: 5.10
Linear guide type	4 rows of circular arc grooves x 2 rail
Position detector	Resolvers ^{Note 3}
Resolution (Pulse/rotation)	16384

Note 1. Positioning repeatability in one direction.
 Note 2. A regenerative unit is needed if using the SR1-X, TS-X at maximum speeds exceeding 1000mm/sec.. If using the RDV-X, then the regenerative unit RBR1 is required regardless of the installation conditions.
 Note 3. Position detectors(resolvers) are common to incremental and absolute specifications. If the controller has a backup function then it will be absolute specifications.

Allowable overhang^{Note}

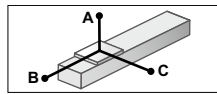

		Horizontal installation (Unit: mm)		
		A	B	C
Lead 20	20kg	3397	2332	2683
	40kg	2795	1144	1361
	60kg	2443	749	914
	80kg	2193	551	695

Note. Distance from center of slider top to center of gravity of object being carried at a guide service life of 10,000 km.

Static loading moment

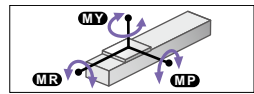

			(Unit: N·m)
MY	MP	MR	
1196	1199	1052	

Controller

Controller	Operation method
SR1-X20 ^{Note} RCX221/222 RCX240/340	Programming / I/O point trace / Remote command / Operation using RS-232C communication
TS-X220 ^{Note} RDV-X220-RBR1	I/O point trace / Remote command / Pulse train control

Note. When the unit is operated at a speed exceeding the maximum speed of 1,000mm/sec., a regeneration unit is required.

F20N

219+/-3: When origin is on L side
(219: When origin is on R side)

Effective stroke

201+/-3: When origin is on R side
(201: When origin is on L side)

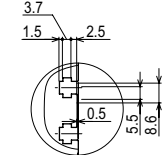
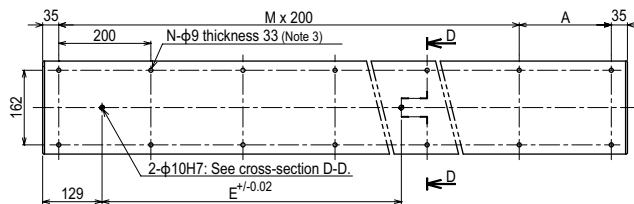
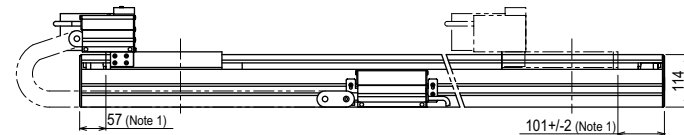
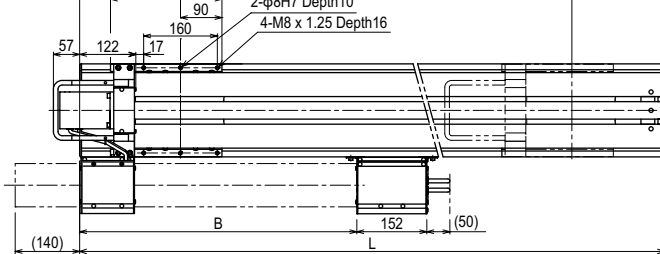

C section detailed chart

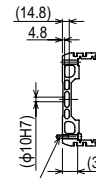
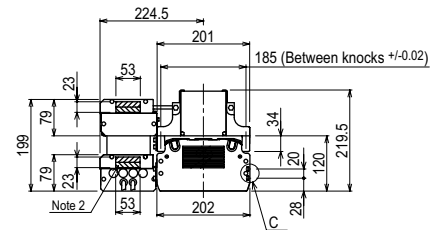

Cross section of cable guide

Use M8 x 1.25 hex socket head bolt with length head bolt with length (under head) of 45mm or more.

Cross-section D-D

Effective stroke	1150	1250	1350	1450	1550	1650	1750	1850	1950	2050
L	1570	1670	1770	1870	1970	2070	2170	2270	2370	2470
A	100	200	100	200	100	200	100	200	100	200
B	602	648	694	740	786	832	878	924	970	1016
E	1320	1320	1320	1320	1320	1320	1320	1320	1320	1320
M	7	7	8	8	9	9	10	10	11	11
N	18	18	20	20	22	22	24	24	26	26
Weight (kg)	54.0	56.2	58.4	60.6	62.9	65.1	67.3	69.6	71.8	74.0

Note 1. Stop positions are determined by the mechanical stoppers at both ends.
 Note 2. The shaded position indicates the user cable extraction port.
 Note 3. When installing the robot, do not use washers inside the robot body.
 Note 4. The origin is set on the left (L) side of the slipping.

N15



Ordering method

N15-20

Model	Lead designation	Cable carrier entry location	Cable carrier specification	Origin position change	Grease type	Stroke	Cable length
		RH: Horizontal, right LH: Horizontal, left RW: Wall, right LW: Wall, left	S: Standard M: Optional C: Cable carrier	Hori- zontal None: R side (Standard) Z: L side Wall None: L side (Standard) Z: R side	None: Standard GC: Clean	500 to 2000 (100mm pitch)	3L: 3.5m 5L: 5m 10L: 10m 3K/5K/10K (Flexible cable)

TSX Positioner	220 Driver: Power-supply voltage / Power capacity 220: 200V/400 to 600W	R Regenerative unit R: With RGT	LCD monitor No entry: None L: With LCD	I/O selection NP: NPN PN: PNP CC: CC-Link DN: DeviceNet™ EP: EtherNet/IP™ PT: PROFINET GW: No I/O board	Battery B: With battery (Absolute) N: None (Incremental)
SR1-X Controller	20 Driver: Power capacity 20: 400 to 600W	Usable for CE No entry: Standard E: CE marking	R Regenerative unit R: With RGT	I/O selection N: NPN P: PNP CC: CC-Link DN: DeviceNet™ PB: PROFIBUS	Battery B: With battery (Absolute) N: None (Incremental)
RDV-X Driver	2 Power-supply voltage 2: AC200V	20 Driver: Power capacity 20: 600W or less	RBR1 Regenerative unit		

Note 1. To find information on cable carrier extraction directions see P.173.
 Note 2. The robot cable is standard cable (3L/5L/10L), but can be changed to flexible cable. See P.594 for details on robot cable.
 Note 3. See P.498 for DIN rail mounting bracket.
 Note 4. Select this selection when using the gateway function. For details, see P.60.

Specifications

AC servo motor output (W)	400
Repeatability (mm)	+/-0.01
Deceleration mechanism	Ball screw φ15 (Class C7)
Ball screw lead (mm)	20
Maximum speed (mm/sec)	1200
Maximum payload (kg)	50
Rated thrust (N)	339
Stroke (mm)	500 to 2000 (100mm pitch)
Overall length (mm)	Stroke+330
Maximum dimensions of cross section of main unit (mm)	W145 × H120
Cable length (m)	Standard: 3.5 / Option: 5.10
Linear guide type	4 rows of circular arc grooves × 2 rail
Position detector	Resolvers
Resolution (Pulse/rotation)	16384

Note 1. Positioning repeatability in one direction.
 Note 2. The maximum speed may not be reached when the moving distance is short.
 Note 3. Position detectors (resolvers) are common to incremental and absolute specifications. If the controller has a backup function then it will be absolute specifications.

Allowable overhang

Horizontal installation (Unit: mm)	Wall installation (Unit: mm)		
	A	B	C
Lead 20	10kg 3048	2322	1259
	30kg 1489	841	500
	50kg 1278	544	344

Note. Distance from center of slider top to center of gravity of object being carried at a guide service life of 10,000 km.

Static loading moment

(Unit: N·m)		
MY	MP	MR
691	692	608

Controller

Controller	Operation method
SR1-X20-R RCX221/222 RCX240/340	Programming / I/O point trace / Remote command / Operation using RS-232C communication
TS-X220-R	I/O point trace / Remote command
RDV-X220-RBR1	Pulse train control

Cable carrier for users

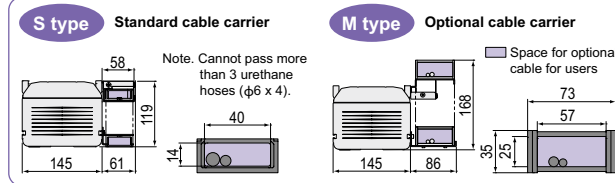

N15: Horizontal installation / Standard Cable carrier specification

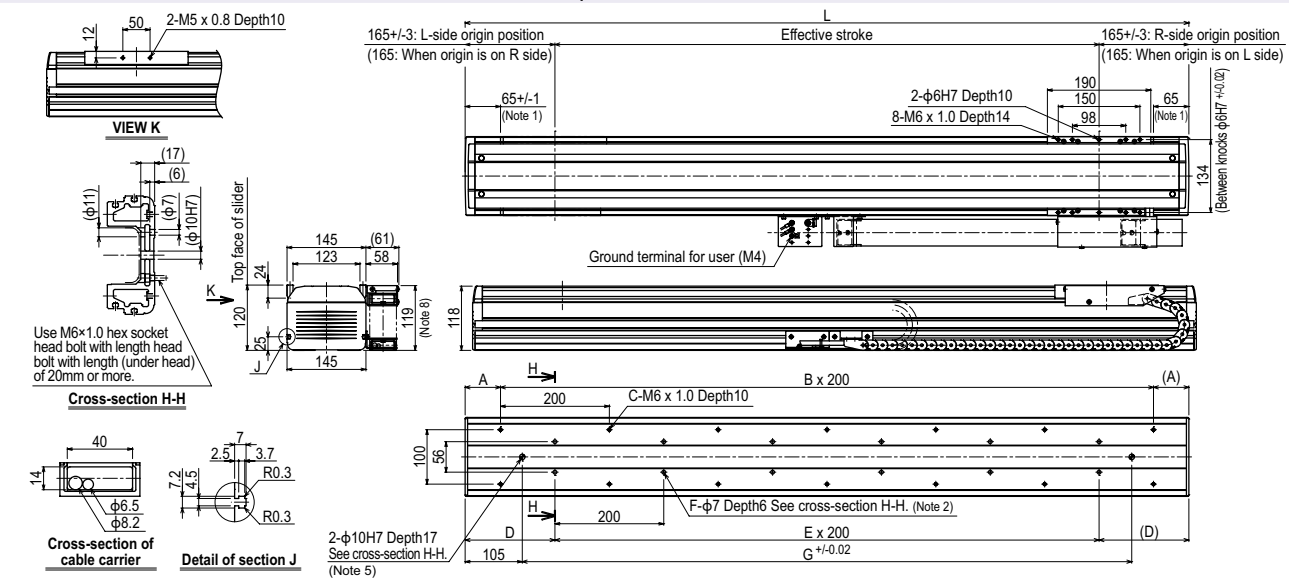

Note 1. Stop positions are determined by the mechanical stoppers at both ends.
 Note 2. When using φ7 holes for installation, do not use a washer, spring washer, etc. in the main unit.
 Note 3. When shipped from the factory, the horizontal model has the origin on the right side and the wall model has the origin on the left side. (This diagram shows the machine whose cable carrier taken out from right.)
 Note 4. If the model is a standard cable carrier specification, it is not possible to pass 3 or more φ6 × 4 urethane air hoses.
 Note 5. When using a φ10H7 hole, make sure that the pin does not go into deeper than as shown in the drawing.
 Note 6. Contact us for vertical installation.
 Note 7. Weight of models with no brake. The weight of brake-attached models is 1 kg heavier than the models with no brake shown in the table.
 Note 8. Depending on the stroke and the operating conditions, the cable carrier bending radius might be larger, making it higher than the dimensions shown in the diagram.

Effective stroke	500	600	700	800	900	1000	1100	1200	1300	1400	1500	1600	1700	1800	1900	2000
L	830	930	1030	1130	1230	1330	1430	1530	1630	1730	1830	1930	2030	2130	2230	2330
A	15	65	15	65	15	65	15	65	15	65	15	65	15	65	15	65
B	4	4	5	5	6	6	7	7	8	8	9	9	10	10	11	11
C	10	10	12	12	14	14	16	16	18	18	20	20	22	22	24	24
D	115	165	115	165	115	165	115	165	115	165	115	165	115	165	115	165
E	3	3	4	4	5	5	6	6	7	7	8	8	9	9	10	10
F	8	8	10	10	12	12	14	14	16	16	18	18	20	20	22	22
G	620	720	820	920	1020	1120	1220	1320	1420	1520	1620	1720	1820	1920	2020	2120
Weight (kg)	19	20	22	23	24	26	27	29	30	32	33	35	36	38	39	40

N15: Horizontal installation / Optional Cable carrier specification **RH**

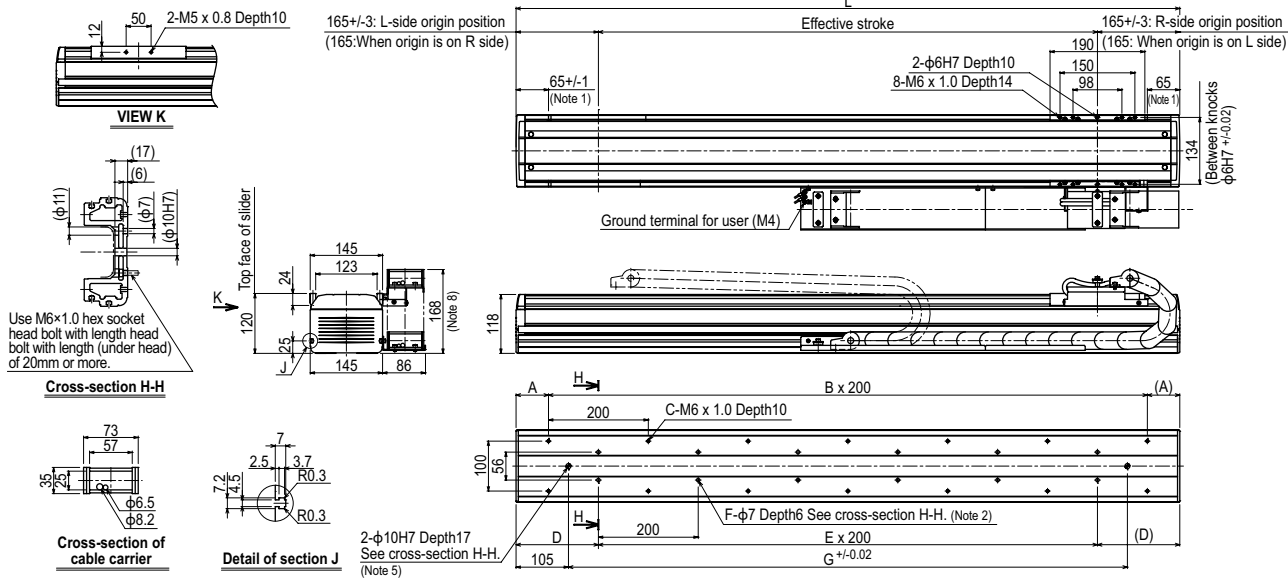

N15: Wall installation / Standard Cable carrier specification **RW**

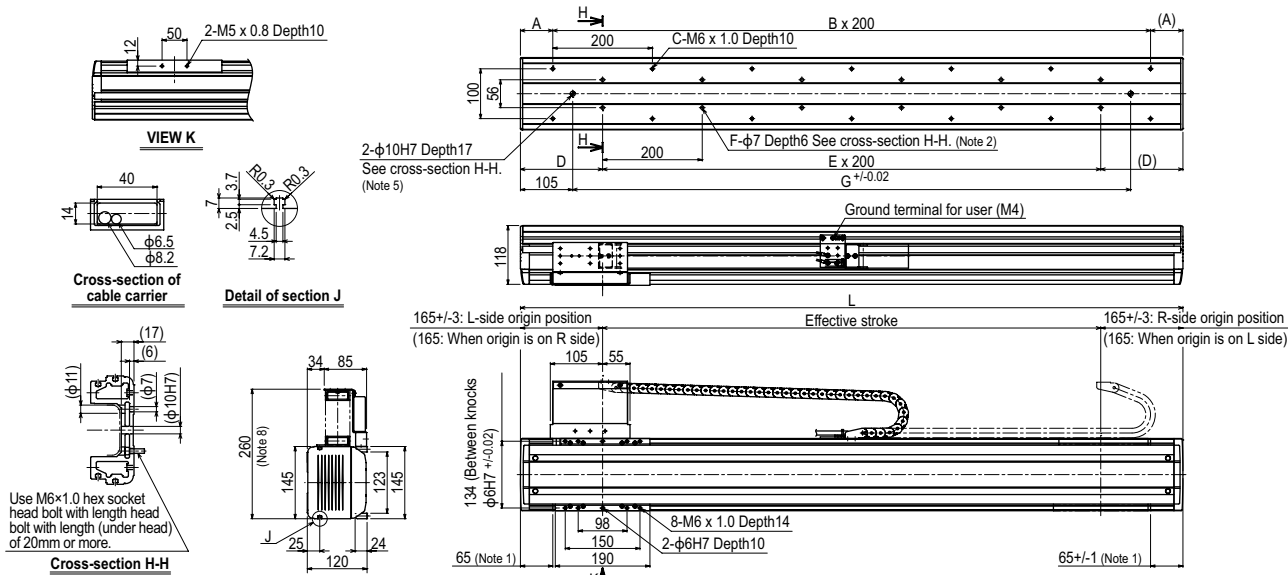

N15: Wall installation / Optional Cable carrier specification **RW**

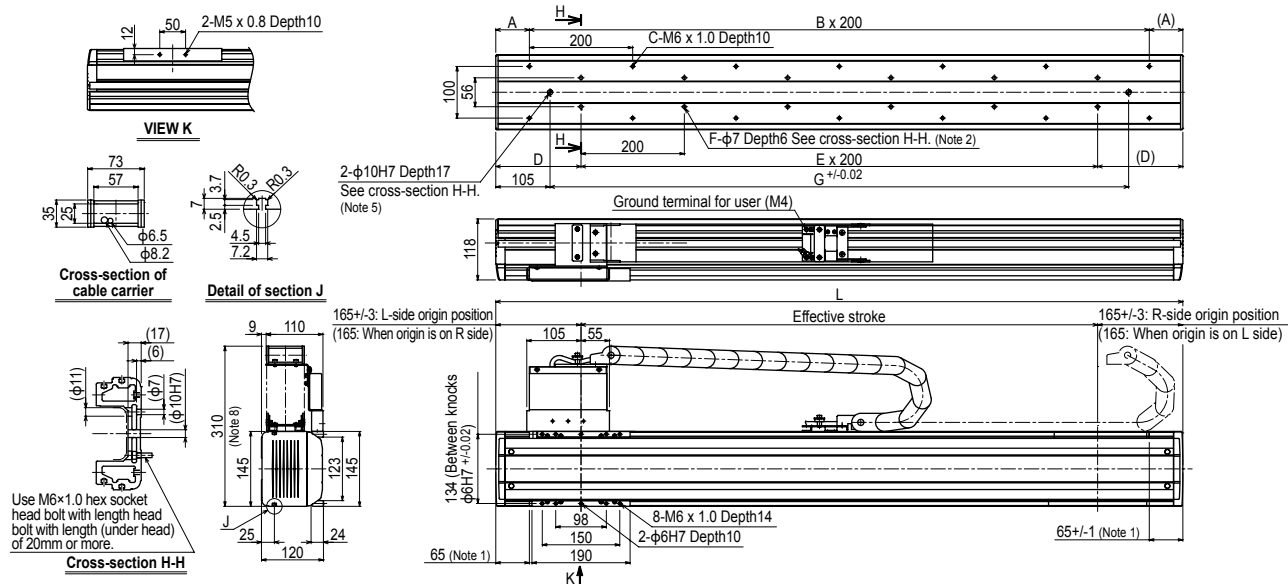

N15D

Double carriage

Ordering method

N15D-20							RCX222HP		R		
Model	Lead designation	Installation direction	Cable carrier specification	Option	Stroke	Cable length	Controller ^{Note 1}	Usable for CE	Regenerative unit	I/O selection 1	I/O selection 2
		H: Horizontal installation W: Wall installation	S: Standard Cable carrier M: Optional Cable carrier	Grease type None: Standard GC: Clean	250 to 1750 (100mm pitch)	3L: 3.5m 5L: 5m 10L: 10m 3K/5K/10K (Flexible cable) ^{Note 5}	RCX222HP SR1-X (2 units) ^{Note 2} TS-X (2 units) ^{Note 2} RDV-X (2 units) ^{Note 2}	No entry : Standard E: CE marking	R: RG2	N: NPN ^{Note 3} P: PNP CC: CC-Link DN: DeviceNet TM PB: PROFIBUS EN: Ethernet ^{Note 3}	No entry: None NT: OPDIO24/16 (NPN) ^{Note 3} Pt: OPDIO24/17 (PNP) EN: Ethernet ^{Note 3, Note 4}

Note 1. To find controller selection options for other than the RCX222HP, see the ordering method on each controller page.

Note 2. 2 units are required when using SR1-X, TS-X or RDV-X.

Note 3. NPN and Ethernet cannot be selected when using CE marking.

Note 4. Only when you have selected CC, DN or PB for Input/Output selection 1, you can select EN for Input/Output selection 2.

Note 5. If a flexible cable is needed for the SR1-X, TS-X, or RDV-X, then select 3K/5K/10K. On the RCX222HP, the standard cable is a flexible cable, so enter 3L/5L/10L when ordering.

Specifications

AC servo motor output (W)	400
Repeatability ^{Note 1} (mm)	+/-0.01
Deceleration mechanism	Ball screw φ15 (Class C7)
Ball screw lead (mm)	20
Maximum speed ^{Note 2} (mm/sec)	1200
Maximum payload (kg)	50
Rated thrust (N)	339
Stroke (mm)	250 to 1750 (100mm pitch)
Overall length (mm)	Stroke+330
Maximum dimensions of cross section of main unit (mm)	W145 × H120
Cable length (m)	Standard: 3.5 / Option: 5.10
Linear guide type	4 rows of circular arc grooves × 2 rail
Position detector	Resolvers ^{Note 3}
Resolution (Pulse/rotation)	16384

Note 1. Positioning repeatability in one direction.

Note 2. The maximum speed may not be reached when the moving distance is short.

Note 3. Position detectors (resolvers) are common to incremental and absolute specifications. If the controller has a backup function then it will be absolute specifications.

Allowable overhang^{Note}

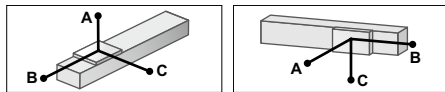

Horizontal installation (Unit: mm)	Horizontal installation (Unit: mm)			Wall installation (Unit: mm)	Wall installation (Unit: mm)			
	A	B	C		A	B	C	
Lead 20	10kg	3048	2322	1259	10kg	1258	1823	2449
	30kg	1489	841	500	30kg	428	545	1039
	50kg	1278	544	344	50kg	248	289	749

Note. Distance from center of slider top to center of gravity of object being carried at a guide service life of 10,000 km.

Static loading moment

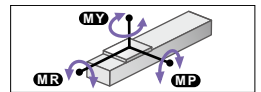

(Unit: N·m)		
MY	MP	MR
691	692	608

Controller

Controller	Operation method
RCX222HP-R	Programming / I/O point trace / Remote command / Operation using RS-232C communication
SR1-X20-R ^{Note}	I/O point trace / Remote command
TS-X220-R ^{Note}	Pulse train control
RDV-X20-RBR1 ^{Note}	

Note. 2 units are required when using SR-1, TS-X or RDV-X.

Cable carrier for users

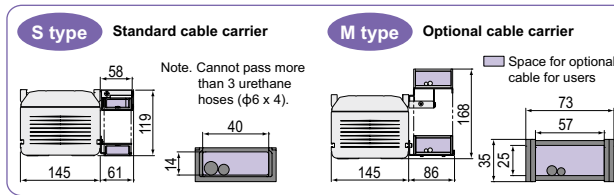

N15D: Horizontal installation / Standard Cable carrier specification

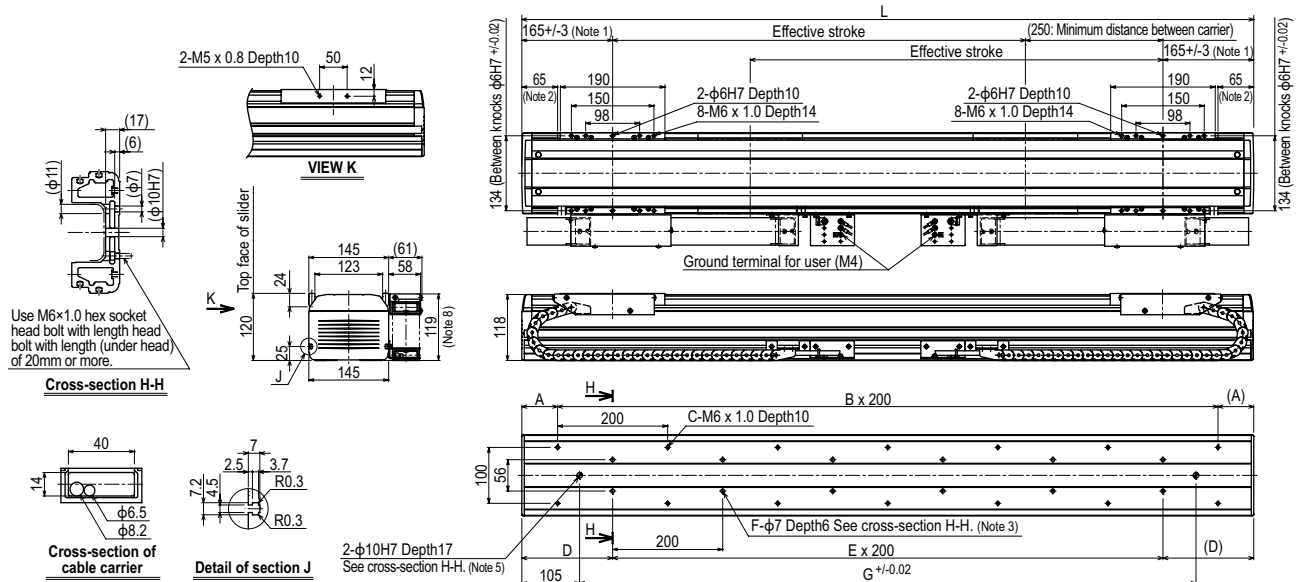

Note 1. Position of table carriage when searched to the origin.

Note 2. Stop positions are determined by the mechanical stoppers at both ends.

Note 3. When using φ7 holes for installation, do not use a washer, spring washer, etc. in the main unit.

Note 4. If the model is a standard cable carrier specification, it is not possible to pass 3 or more φ6 × 4 urethane air hoses.

Note 5. When using a φ10H7 hole, make sure that the pin does not go into deeper than as shown in the drawing.

Note 6. Contact us for vertical installation.

Note 7. Weight of models with no brake. The weight of brake-attached models is 1 kg heavier than the models with no brake shown in the table.

Note 8. Depending on the stroke and the operating conditions, the cable carrier bending radius might be larger, making it higher than the dimensions shown in the diagram.

Effective stroke	250	350	450	550	650	750	850	950	1050	1150	1250	1350	1450	1550	1650	1750
L	830	930	1030	1130	1230	1330	1430	1530	1630	1730	1830	1930	2030	2130	2230	2330
A	15	65	15	65	15	65	15	65	15	65	15	65	15	65	15	65
B	4	4	5	5	6	6	7	7	8	8	9	9	10	10	11	11
C	10	10	12	12	14	14	16	16	18	18	20	20	22	22	24	24
D	115	165	115	165	115	165	115	165	115	165	115	165	115	165	115	165
E	3	3	4	4	5	5	6	6	7	7	8	8	9	9	10	10
F	8	8	10	10	12	12	14	14	16	16	18	18	20	20	22	22
G	620	720	820	920	1020	1120	1220	1320	1420	1520	1620	1720	1820	1920	2020	2120
Weight (kg) ^{Note 7}	24	26	27	29	30	32	33	35	36	38	39	40	42	43	45	46

N15D: Horizontal installation / Optional Cable carrier specification

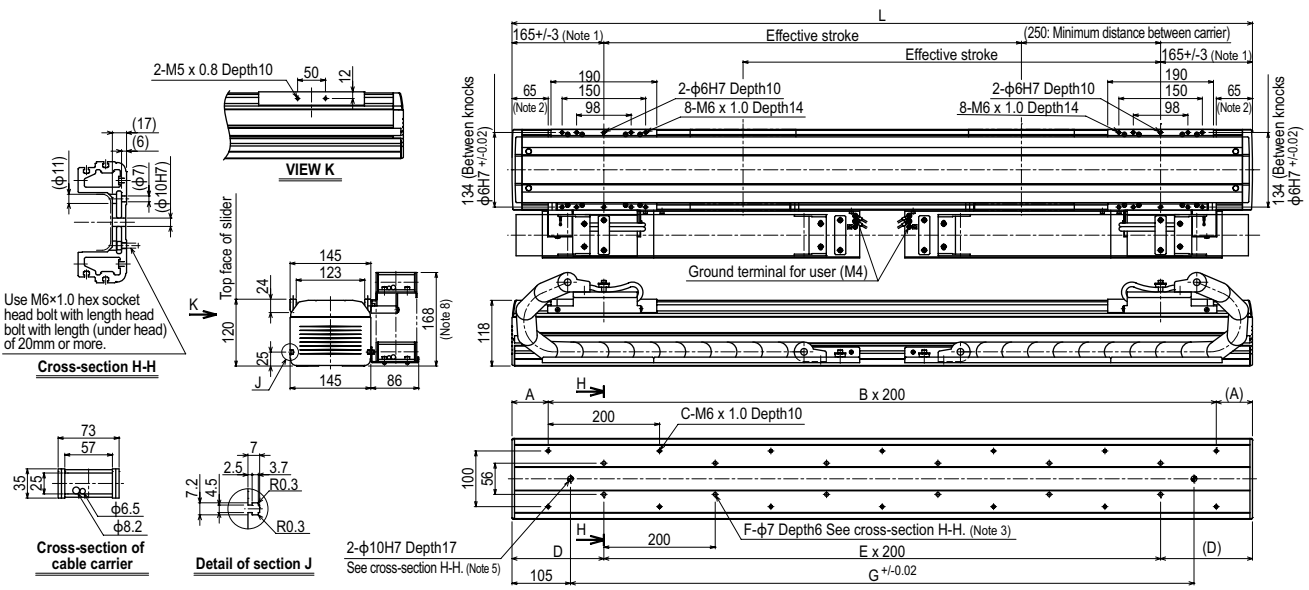

N15D: Wall installation / Standard Cable carrier specification

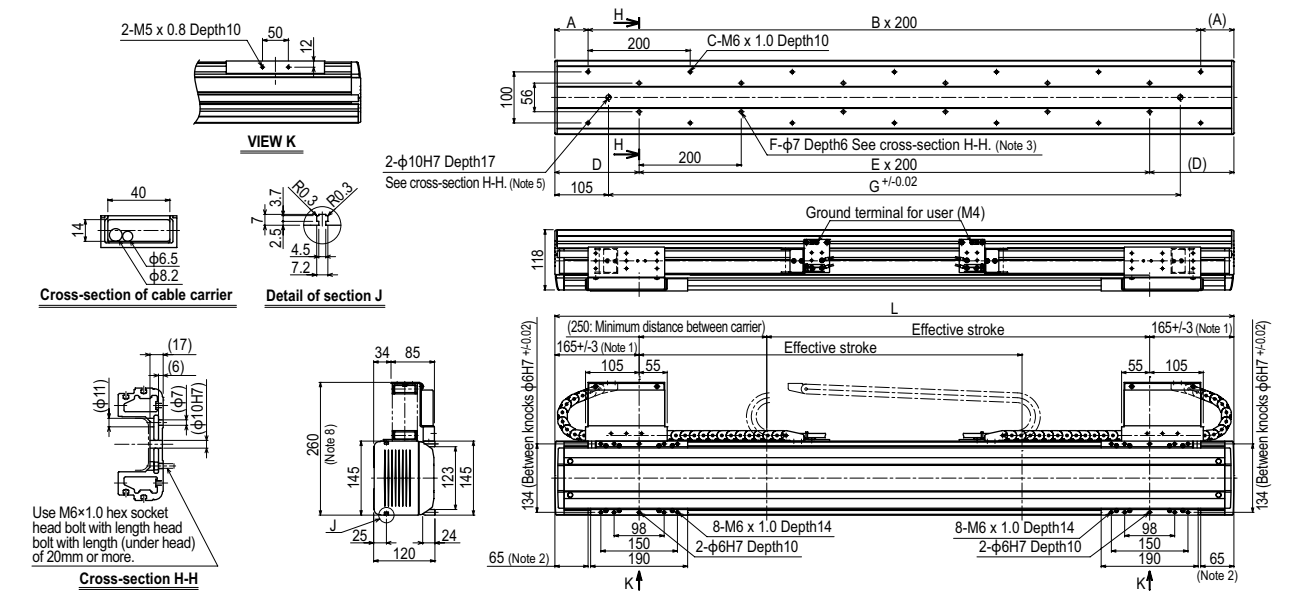

N15D: Wall installation / Optional Cable carrier specification

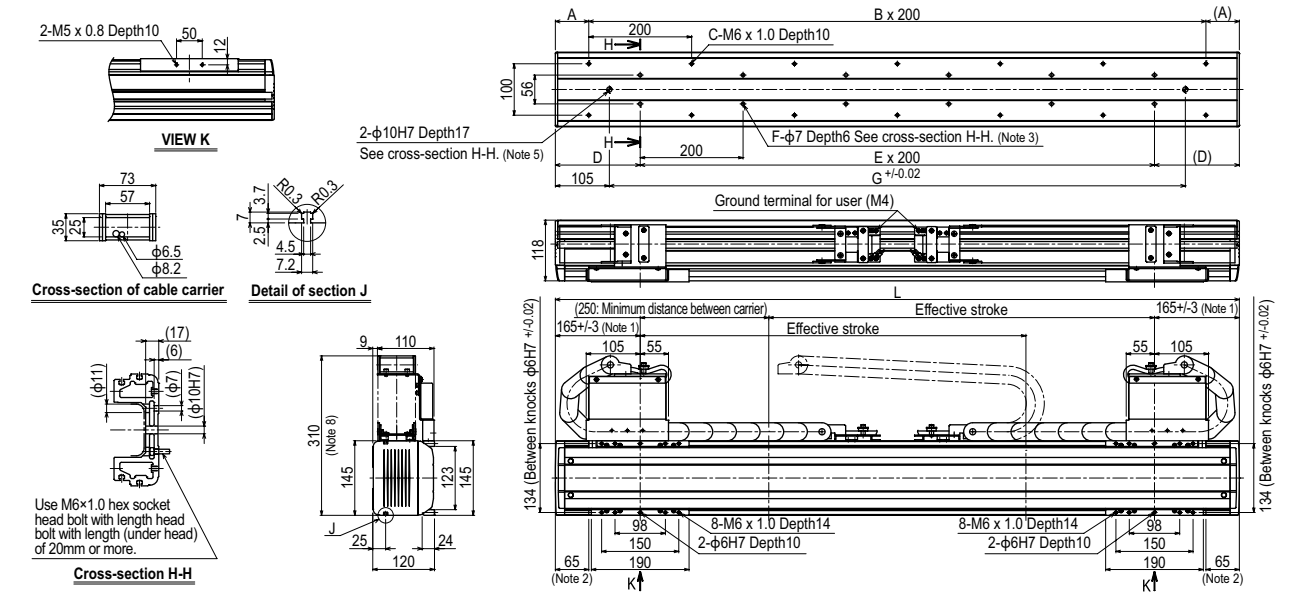

N18



Ordering method

N18- 20

Model	Lead designation	Cable carrier entry location RH: Horizontal, right LH: Horizontal, left RW: Wall, right LW: Wall, left	Cable carrier specification S: Standard Cable carrier M: Optional Cable carrier	Origin position change Horizontal: None, R side (Standard) Z: L side Wall: None, L side (Standard) Z: R side	Grease type None, Standard GC: Clean	Stroke 500 to 2500 (100mm pitch)	Cable length ^{Note 2} 3L: 3.5m 5L: 5m 10L: 10m 3K/5K/10K (Flexible cable)	TSX Positioner ^{Note 3} TS-X	220 Driver: Power-supply voltage / Power capacity 220: 200V/400 to 600W	R Regenerative unit R: With RGT	LCD monitor No entry: None L: With LCD	I/O selection NP: NPN P: PNP CC: CC-Link DN: DeviceNet™ EP: EtherNet/IP™ PT: PROFINET GW: No I/O board ^{Note 4}	Battery B: With battery (Absolute) N: None (Incremental)
SR1-X Controller	20 Driver: Power capacity 20: 400 to 600W	Usable for CE No entry: Standard E: CE marking	R Regenerative unit R: With RGT1	I/O selection N: NPN P: PNP CC: CC-Link DN: DeviceNet™ PB: PROFIBUS	Battery B: With battery (Absolute) N: None (Incremental)								
RDV-X Driver	2 Power-supply voltage 2: AC200V	20 Driver: Power capacity 20: 600W or less	RBR1 Regenerative unit										

Note 1. To find information on cable carrier extraction directions see P.173.
 Note 2. The robot cable is standard cable (3L/5L/10L), but can be changed to flexible cable. See P.594 for details on robot cable.
 Note 3. See P.498 for DIN rail mounting bracket.
 Note 4. Select this selection when using the gateway function. For details, see P.60.

Specifications

AC servo motor output (W)	400
Repeatability ^{Note 1} (mm)	+/-0.01
Deceleration mechanism	Ball screw φ20 (Class C7)
Ball screw lead (mm)	20
Maximum speed ^{Note 2} (mm/sec)	1200
Maximum payload (kg)	80
Rated thrust (N)	339
Stroke (mm)	500 to 2500 (100mm pitch)
Overall length (mm)	Stroke+362
Maximum dimensions of cross section of main unit (mm)	W180 × H115
Cable length (m)	Standard: 3.5 / Option: 5.10
Linear guide type	4 rows of circular arc grooves × 2 rail
Position detector	Resolvers ^{Note 3}
Resolution (Pulse/rotation)	16384

Note 1. Repeatability for single oscillation.
 Note 2. The maximum speed may not be reached when the moving distance is short.
 Note 3. Position detectors (resolvers) are common to incremental and absolute specifications. If the controller has a backup function then it will be absolute specifications.

Allowable overhang^{Note}

Horizontal installation (Unit: mm)	Horizontal installation (Unit: mm)			Wall installation (Unit: mm)		
	A	B	C	A	B	C
Lead 20	3045	1629	1902	3045	1553	3045
30kg	3045	1629	1902	3045	1553	3045
50kg	2602	961	1150	1157	885	2602
80kg	2193	586	716	707	509	2193

Note. Distance from center of slider top to center of gravity of object being carried at a guide service life of 10,000 km.

Static loading moment

(Unit: N·m)		
MY	MP	MR
1161	1163	1021

Controller

Controller	Operation method
SR1-X20-R RCX221/222 RCX240/340	Programming / I/O point trace / Remote command / Operation using RS-232C communication
TS-X220-R	I/O point trace / Remote command
RDV-X220-RBR1	Pulse train control

Cable carrier for users

S type Standard cable carrier
 Note. Cannot pass more than 3 urethane hoses (φ6 × 4).
 Dimensions: 180mm width, 61mm depth, 58mm height, 114mm total height.

M type Optional cable carrier
 Space for optional cable for users.
 Dimensions: 180mm width, 86mm depth, 166mm height, 73mm cable space, 57mm cable space, 35mm cable space.

N18: Horizontal installation / Standard Cable carrier specification RH

Cross-section E-E
 Use M8 x 1.25 hex socket head bolt with length head bolt with length (under head) of 40mm or more.
 Dimensions: 179mm, 156mm, 58mm, 115mm, 114mm, 180mm, 22mm, 36mm, 14mm, 12mm, 50mm, 2-M5 x 0.8 Depth11, φ10H7, φ14, (30), L(φ9).

Cross-section of cable carrier
 Dimensions: 40mm, φ6.5, φ8.2, 14mm.

Detail of section F
 Dimensions: 7mm, 3.7mm, 2.5mm, 7mm, R1, R0.3.

Side View
 Effective stroke L, 181±/3: L-side origin position (181: When origin is on R side), 78±/1 (Note 1), 181±/3: R-side origin position (181: When origin is on L side), 2-φ6H7 Depth10, 8-M8 x 1.25 Depth25, 190mm, 150mm, 98mm, 78mm (Note 1), 168mm (Between knobs φ6H7 +0.02), Ground terminal for user (M4), (Note 7), B x 200, C-φ9 Depth30 See cross-section E-E. (Note 2), 2-φ10H7 Depth15 See cross-section E-E. (Note 5), D ±/0.02, 149mm, 106mm, 200mm, E, A, A.

Note 1. Stop positions are determined by the mechanical stoppers at both ends.
 Note 2. When using φ9 holes for installation, do not use a washer, spring washer, etc. in the main unit.
 Note 3. When shipped from the factory, the horizontal model has the origin on the right side and the wall model has the origin on the left side. (This diagram shows the machine whose cable carrier taken out from right.)
 Note 4. If the model is a standard cable carrier specification, it is not possible to pass 3 or more φ6 × 4 urethane air hoses.
 Note 5. When using a φ10H7 hole, make sure that the pin does not go into deeper than as shown in the drawing.
 Note 6. Contact us for vertical installation.
 Note 7. For the robot with more than 2,100 stroke, a roller is installed to prevent the cable carrier hanging.
 Note 8. Weight of models with no brake. The weight of brake-attached models is 1 kg heavier than the models with no brake shown in the table.
 Note 9. Depending on the stroke and the operating conditions, the cable carrier bending radius might be larger, making it higher than the dimensions shown in the diagram.

Effective stroke	500	600	700	800	900	1000	1100	1200	1300	1400	1500	1600	1700	1800	1900	2000	2100	2200	2300	2400	2500
L	862	962	1062	1162	1262	1362	1462	1562	1662	1762	1862	1962	2062	2162	2262	2362	2462	2562	2662	2762	2862
A	131	81	131	81	131	81	131	81	131	81	131	81	131	81	131	81	131	81	131	81	131
B	3	4	4	5	5	6	6	7	7	8	8	9	9	10	10	11	11	12	12	13	13
C	8	10	10	12	12	14	14	16	16	18	18	20	20	22	22	24	24	26	26	28	28
D	650	750	850	950	1050	1150	1250	1350	1450	1550	1650	1750	1850	1950	2050	2150	2250	2350	2450	2550	2650
Weight (kg) ^{Note 8}	27	29	31	33	35	37	39	41	43	45	47	48	50	52	54	56	58	60	62	64	66

N18: Horizontal installation / Optional Cable carrier specification **RH**

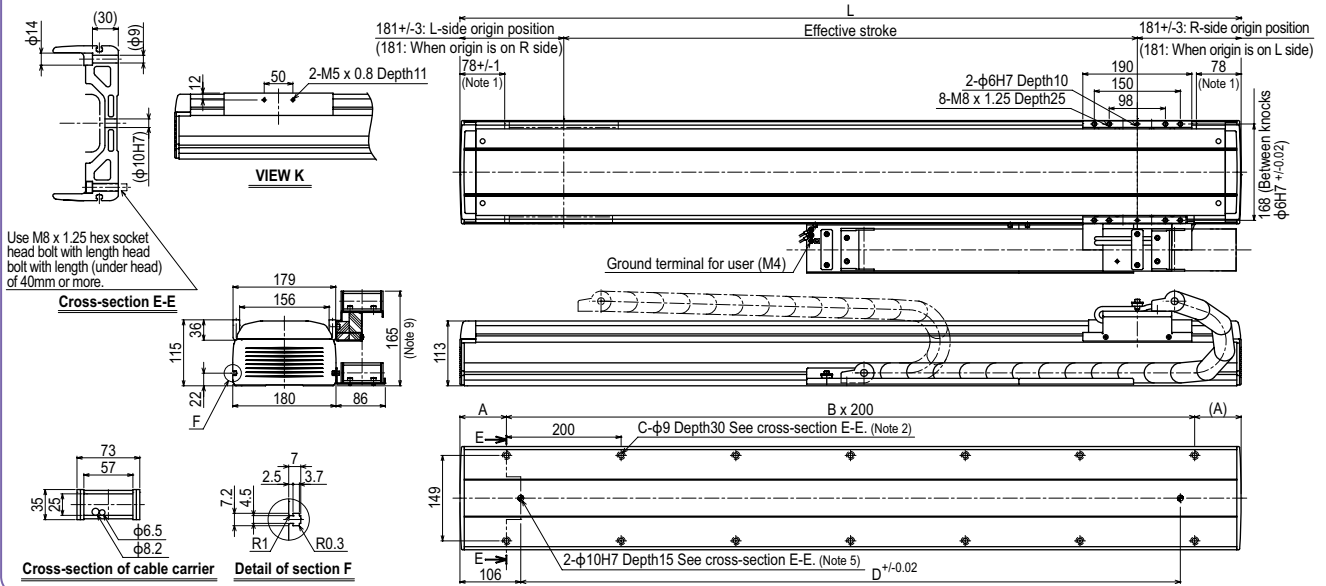

N18: Wall installation / Standard Cable carrier specification **RW**

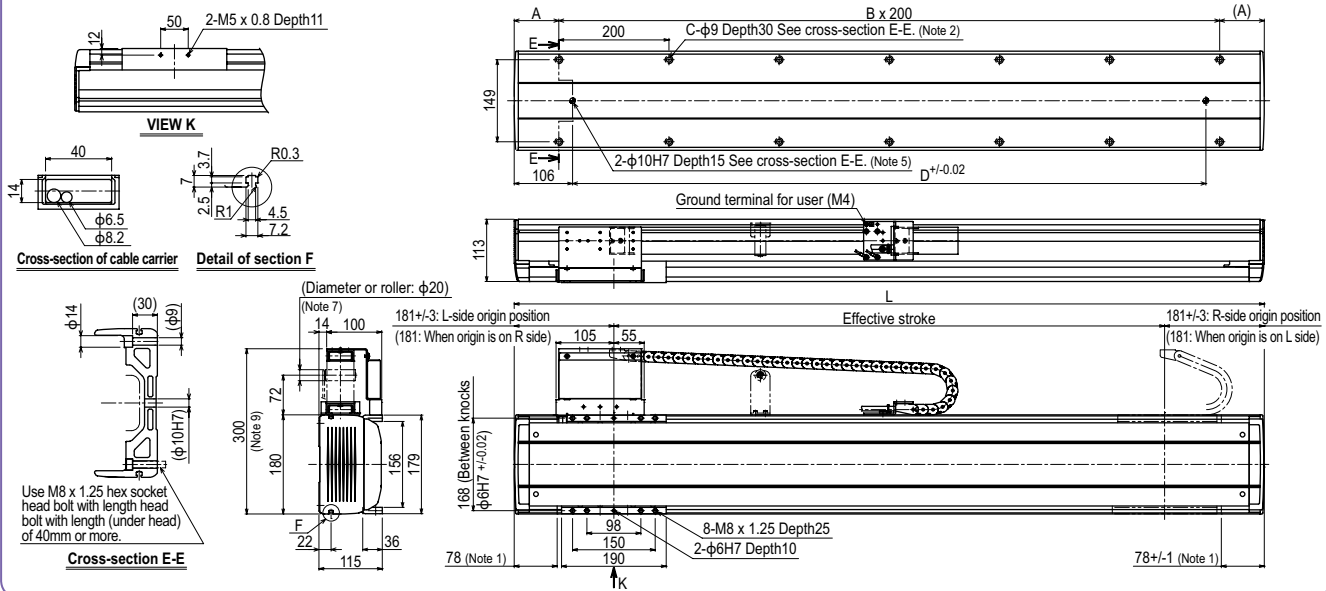

N18: Wall installation / Optional Cable carrier specification **RW**

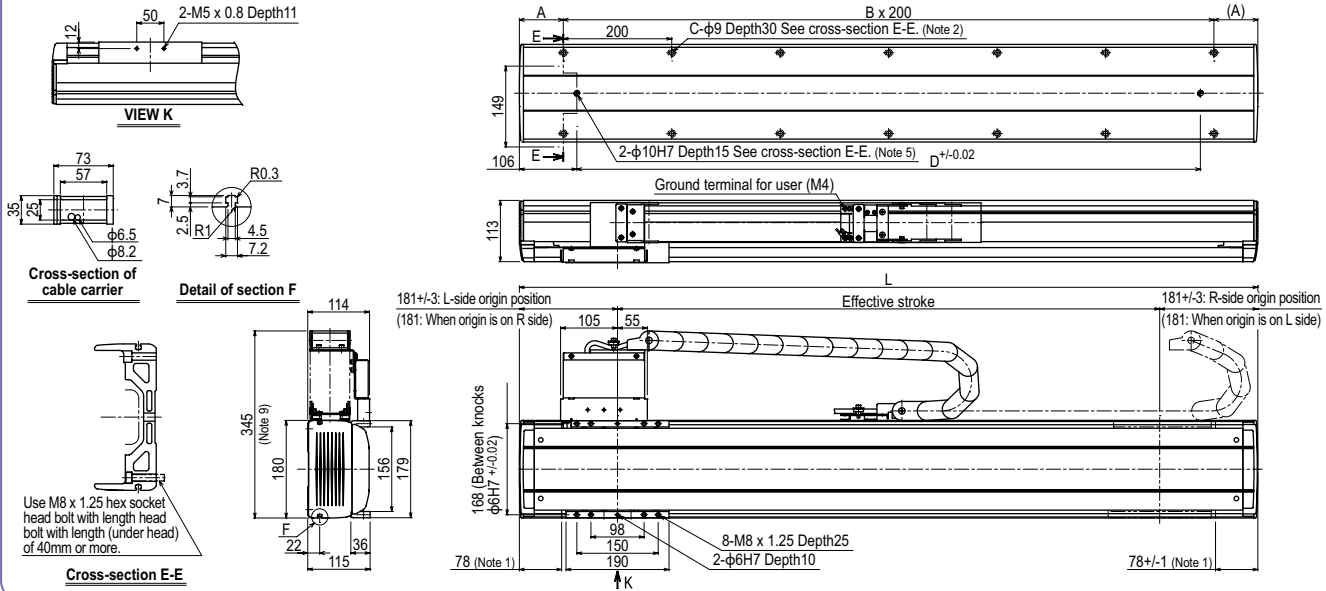

- Articulated robots
YA
- Linear conveyor modules
LCM100
- Compact single-axis robots
TRANSEVO
- Single-axis robots
FLIP-X
- Linear motor single-axis robots
PHASER
- Cartesian robots
XX-X
- SCARA robots
YK-X
- Pick & place robots
YP-X
- CLEAN
- CONTROLLER INFORMATION
- T type
- F type
- GF type
- N type
- B/R type

N18D

Double carriage

Ordering method

N18D - 20						RCX222HP		R			
Model	Lead designation	Installation direction	Cable carrier specification	Option	Stroke	Cable length	Controller ^{Note 1}	Usable for CE marking	Regenerative unit	I/O selection1	I/O selection2
		H: Horizontal installation W: Wall installation	S: Standard Cable carrier M: Optional Cable carrier	Grease type None: Standard GC: Clean	250 to 2250 (100mm pitch)	3L: 3.5m 5L: 5m 10L: 10m 3K/5K/10K (Flexible cable) ^{Note 5}	RCX222HP SR1-X (2 units) ^{Note 2} TS-X (2 units) ^{Note 2} RDV-X (2 units) ^{Note 2}	No entry: Standard E: CE	R: RG2	N: NPN ^{Note 3} P: PNP CC: CC-Link DN: DeviceNet™ PB: PROFIBUS EN: Ethernet ^{Note 3}	No entry: None N1: OP.DI024/16 (NPN) ^{Note 3} P1: OP.DI024/17 (PNP) EN: Ethernet ^{Note 3} ^{Note 4}

Note 1. To find controller selection options for other than the RCX222HP, see the ordering method on each controller page.
 Note 2. 2 units are required when using SR1-X, TS-X or RDV-X.
 Note 3. NPN and Ethernet cannot be selected when using CE marking.
 Note 4. Only when you have selected CC, DN or PB for Input/Output selection 1, you can select EN for Input/Output selection 2.
 Note 5. If a flexible cable is needed for the SR1-X, TS-X, or RDV-X, then select 3K/5K/10K. On the RCX222HP, the standard cable is a flexible cable, so enter 3L/5L/10L when ordering.

Specifications

AC servo motor output (W)	400
Repeatability ^{Note 1} (mm)	+/-0.01
Deceleration mechanism	Ball screw $\phi 20$ (Class C7)
Ball screw lead (mm)	20
Maximum speed ^{Note 2} (mm/sec)	1200
Maximum payload (kg)	80
Rated thrust (N)	339
Stroke (mm)	250 to 2250 (100 pitch)
Overall length (mm)	Stroke+362
Maximum dimensions of cross section of main unit (mm)	W180 x H115
Cable length (m)	Standard: 3.5 / Option: 5, 10
Linear guide type	4 rows of circular arc grooves x 2 rail
Position detector	Resolvers ^{Note 3}
Resolution (Pulse/rotation)	16384

Note 1. Positioning repeatability in one direction.
 Note 2. The maximum speed may not be reached when the moving distance is short.
 Note 3. Position detectors (resolvers) are common to incremental and absolute specifications. If the controller has a backup function then it will be absolute specifications.

Allowable overhang ^{Note}

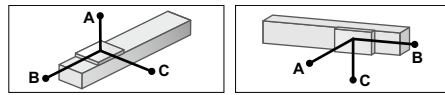

Horizontal installation (Unit: mm)	Horizontal installation (Unit: mm)			Wall installation (Unit: mm)		
	A	B	C	A	B	C
Lead 20	30kg	3045	1629	1928	1553	3045
	50kg	2602	961	1157	885	2602
	80kg	2193	586	716	707	509

Note. Distance from center of slider top to center of gravity of object being carried at a guide service life of 10,000 km.

Static loading moment

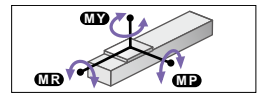

(Unit: N·m)		
MY	MP	MR
1161	1163	1021

Controller

Controller	Operation method
RCX222HP-R	Programming / I/O point trace / Remote command / Operation using RS-232C communication
SR1-X20-R ^{Note}	I/O point trace / Remote command
TS-X220-R ^{Note}	I/O point trace / Remote command
RDV-X20-RBR1 ^{Note}	Pulse train control

Note. 2 units are required when using SR1-X, TS-X or RDV-X.

Cable carrier for users

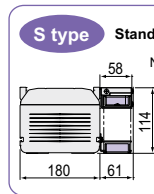
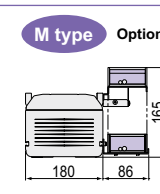
S type	Standard cable carrier	M type	Optional cable carrier
	Standard cable carrier		Optional cable carrier
	Note. Cannot pass more than 3 urethane hoses ($\phi 6 \times 4$).		Space for optional cable for users

N18D: Horizontal installation / Standard Cable carrier specification

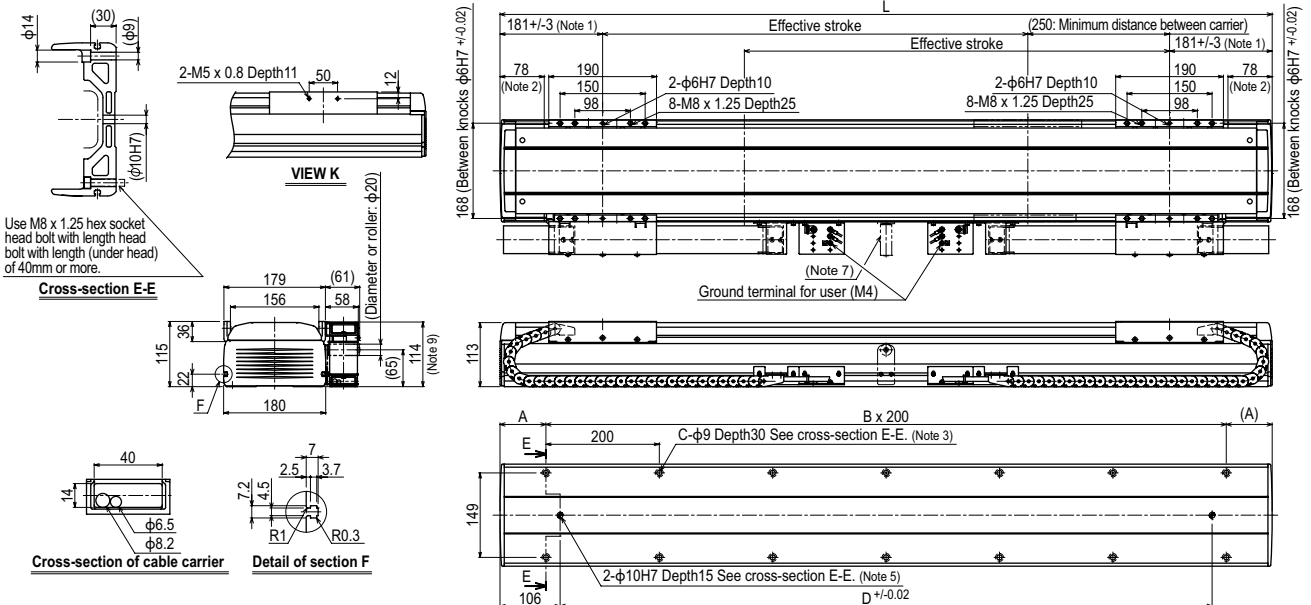

Note 1. Position of table carriage when searched to the origin.
 Note 2. Stop positions are determined by the mechanical stoppers at both ends.
 Note 3. When using $\phi 9$ holes for installation, do not use a washer, spring washer, etc. in the main unit.
 Note 4. If the model is a standard cable carrier specification, it is not possible to pass 3 or more $\phi 6 \times 4$ urethane air hoses.
 Note 5. When using a $\phi 10H7$ hole, make sure that the pin does not go into deeper than as shown in the drawing.
 Note 6. Contact us for vertical installation.
 Note 7. For the robot with more than 2,050 stroke, a roller to prevent the cable carrier from hanging is provided.
 Note 8. Weight of models with no brake. The weight of brake-attached models is 1 kg heavier than the models with no brake shown in the table.
 Note 9. Depending on the stroke and the operating conditions, the cable carrier bending radius might be larger, making it higher than the dimensions shown in the diagram.

Effective stroke	250	350	450	550	650	750	850	950	1050	1150	1250	1350	1450	1550	1650	1750	1850	1950	2050	2150	2250
L	862	962	1062	1162	1262	1362	1462	1562	1662	1762	1862	1962	2062	2162	2262	2362	2462	2562	2662	2762	2862
A	131	81	131	81	131	81	131	81	131	81	131	81	131	81	131	81	131	81	131	81	131
B	3	4	4	5	5	6	6	7	7	8	8	9	9	10	10	11	11	12	12	13	13
C	8	10	10	12	12	14	14	16	16	18	18	20	20	22	22	24	24	26	26	28	28
D	650	750	850	950	1050	1150	1250	1350	1450	1550	1650	1750	1850	1950	2050	2150	2250	2350	2450	2550	2650
Weight (kg) ^{Note 8}	35	37	39	41	43	45	47	48	50	52	54	56	58	60	62	64	66	68	70	72	74

N18D: Horizontal installation / Optional Cable carrier specification

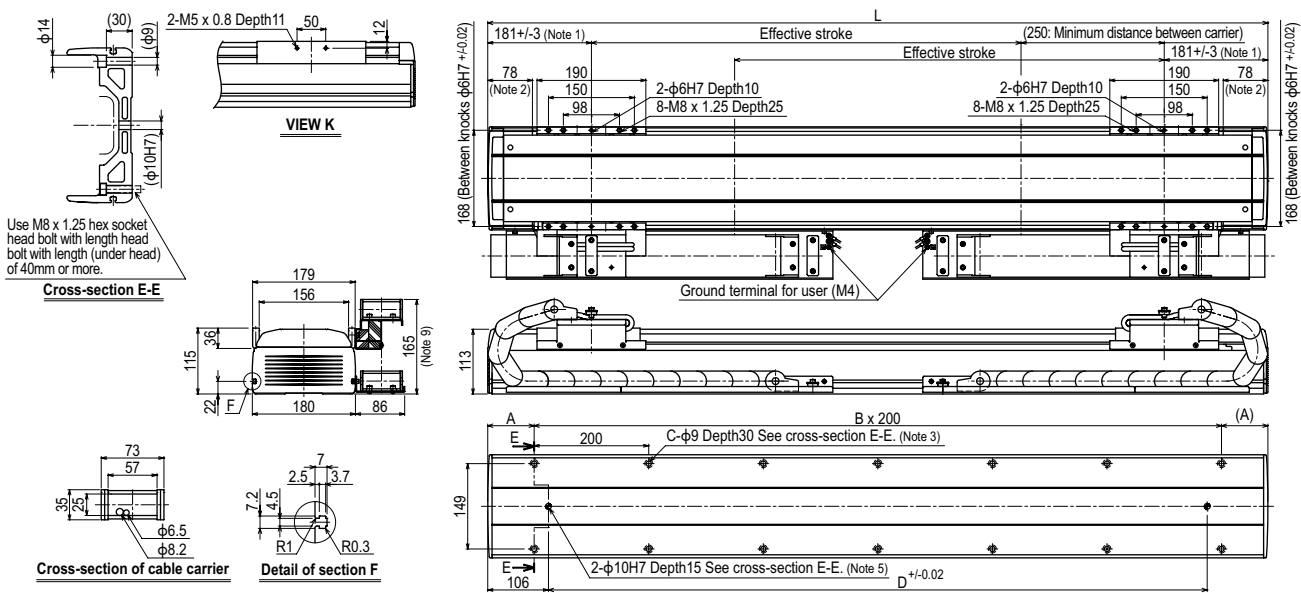

N18D: Wall installation / Standard Cable carrier specification

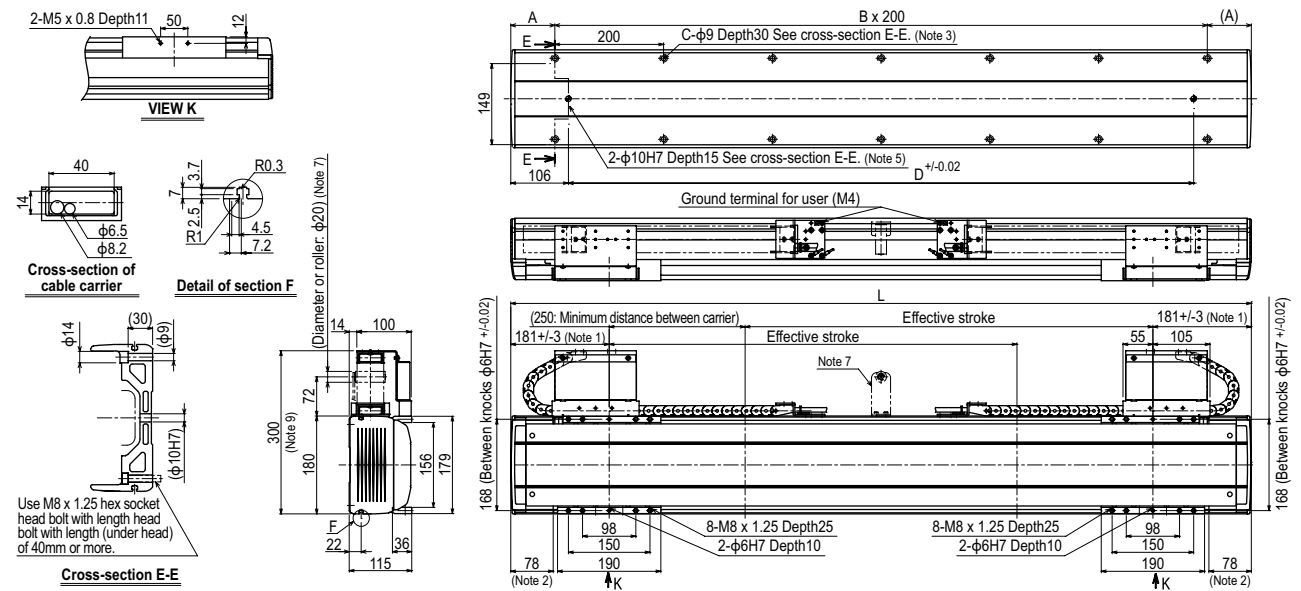

N18D: Wall installation / Optional Cable carrier specification

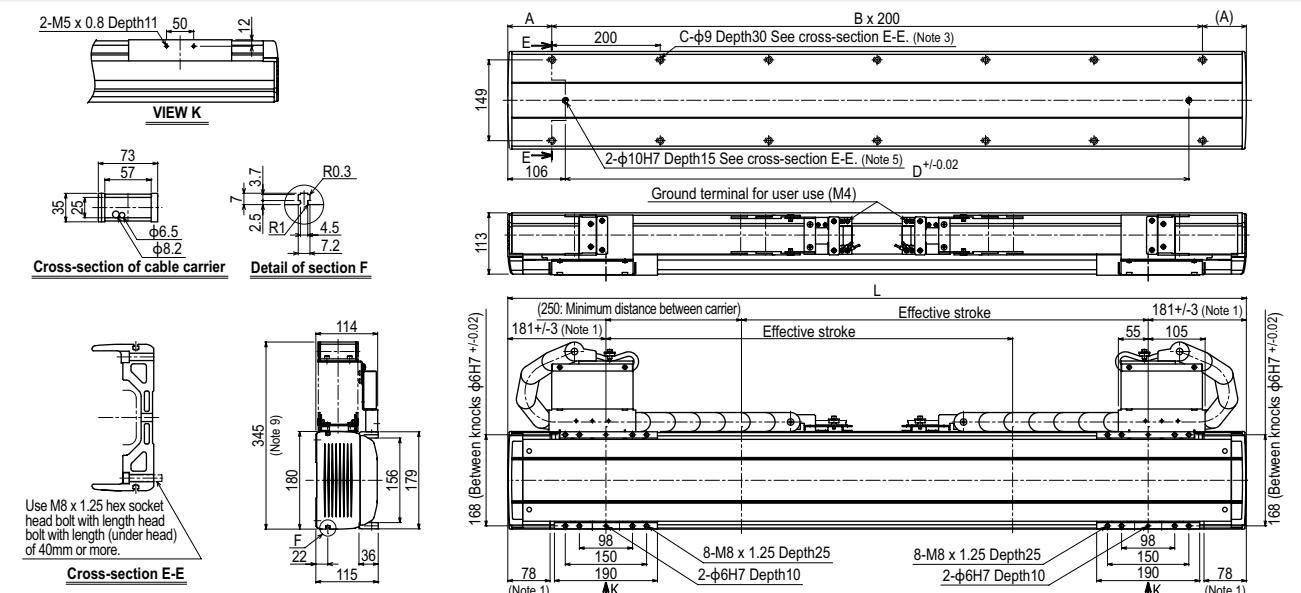

B10



Ordering method

B10

Model	Motor installation direction	Option	Stroke	Cable length ^{Note1}
	L: Motor leftward, horizontal position R: Motor rightward, horizontal position LU: Motor leftward, upper position RU: Motor rightward, upper position LD: Motor leftward, lower position RD: Motor rightward, lower position	Grease type None: Standard GC: Clean	150 to 2550 (100mm pitch)	3L: 3.5m 5L: 5m 10L: 10m 3K/5K/10K (Flexible cable)

TSX

Positioner ^{Note2} TS-X	Driver: Power-supply voltage / Power capacity	LCD monitor	I/O selection	Battery
	105: 100V/100W or less 205: 200V/100W or less	No entry: None L: With LCD	NP: NPN PN: PNP CC: CC-Link DN: DeviceNet™ EP: EtherNet/IP™ PT: PROFINET GW: No I/O board ^{Note3}	B: With battery (Absolute) N: None (Incremental)

SR1-X

Controller	05	Usable for CE	I/O selection	Battery
	Driver: Power capacity 05: 100W or less	No entry: Standard E: CE marking	N: NPN P: PNP CC: CC-Link DN: DeviceNet™ PB: PROFIBUS	B: With battery (Absolute) N: None (Incremental)

RDV-X

Driver	2	05	RBR1
	Power-supply voltage 2: AC200V	Driver: Power capacity 05: 100W or less	Regenerative unit

Note 1. The robot cable is standard cable (3L/5L/10L), but can be changed to flexible cable.
See P.594 for details on robot cable.
Note 2. See P.498 for DIN rail mounting bracket.
Note 3. Select this selection when using the gateway function. For details, see P.60.

Specifications

AC servo motor output (W)	100
Repeatability ^{Note1} (mm)	+/-0.04
Belt (mm)	Equivalent to lead 25
Maximum speed (mm/sec)	1875
Maximum payload (kg)	10
Stroke (mm)	150 to 2550 (100mm pitch)
Overall length (mm)	Stroke+397.5
Motor installation	Stroke+310
L/R type	
Another	
Maximum dimensions of cross section of main unit (mm)	W100 x H81
Cable length (m)	Standard: 3.5 / Option: 5.10
Linear guide type	4 rows of circular arc grooves x 1 rail
Position detector	Resolvers ^{Note2}
Resolution (Pulse/rotation)	16384

Note 1. Positioning repeatability in one direction.
Note 2. Position detectors (resolvers) are common to incremental and absolute specifications. If the controller has a backup function then it will be absolute specifications.

Allowable overhang^{Note}

	Horizontal installation (Unit: mm)			Wall installation (Unit: mm)		
	A	B	C	A	B	C
3kg	1800	1392	1084	1144	1005	1734
5kg	1574	826	696	724	576	1199
8kg	1221	509	474	493	333	918
10kg	1171	403	407	414	254	869

Note. Distance from center of slider top to center of gravity of object being carried at a guide service life of 10,000 km.

Static loading moment

(Unit: N·m)		
MY	MP	MR
188	188	165

Controller

Controller	Operation method
SR1-X05 RCX221/222 RCX240/340	Programming / I/O point trace / Remote command / Operation using RS-232C communication
TS-X105 TS-X205	I/O point trace / Remote command
RDV-X205-RBR1	Pulse train control

Motor installation The line-up consisting of six models of different motor installation position as follows.

L type Leftward at horizontal position	R type Rightward at horizontal position	LU type Leftward at upper position	RU type Rightward at upper position	LD type Leftward at lower position	RD type Rightward at lower position
---	--	---	--	---	--

B10 R type (Motor rightward, horizontal position)

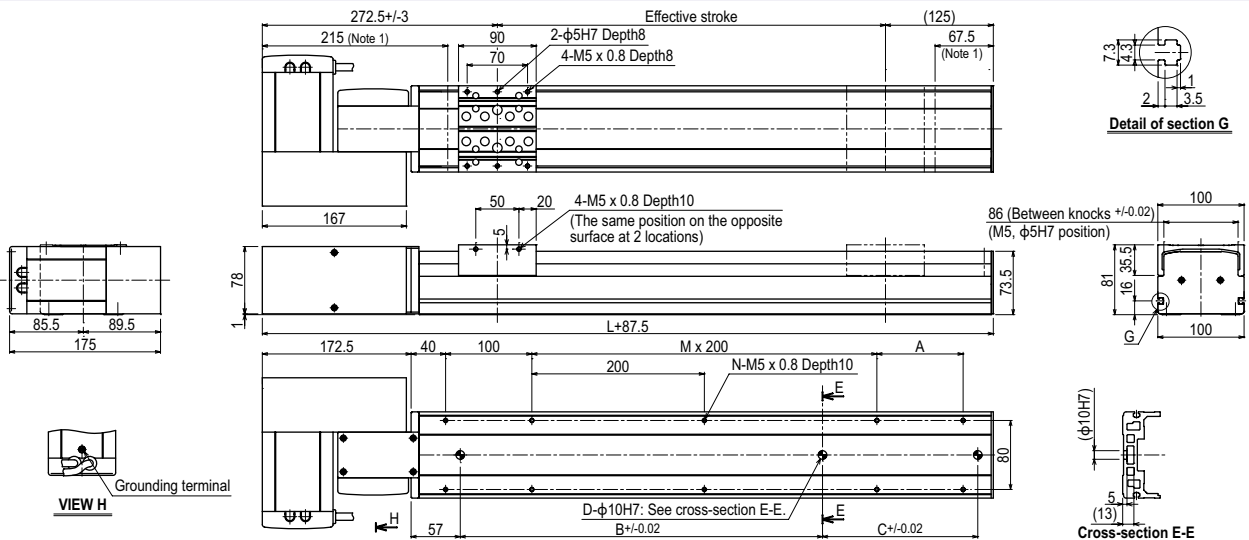

Effective stroke	150	200	250	300	350	400	450	500	550	600	650	700	750	800	850	900	950	1000	1050	1100	1150	1200	1250	1300	1350
L	460	510	560	610	660	710	760	810	860	910	960	1010	1060	1110	1160	1210	1260	1310	1360	1410	1460	1510	1560	1610	1660
A	200	50	100	150	200	50	100	150	200	50	100	150	200	50	100	150	200	50	100	150	200	50	100	150	200
B	240	240	240	420	420	420	600	600	600	600	780	780	780	780	960	960	960	960	1140	1140	1140	1140	1320	1320	1320
C	-	-	-	-	-	-	-	-	-	-	-	-	-	-	-	-	-	-	-	-	-	-	-	-	-
D	2	2	2	2	2	2	2	2	2	2	2	2	2	2	2	2	2	2	2	2	2	2	2	2	2
M	-	1	1	1	1	1	2	2	2	2	3	3	3	3	4	4	4	5	5	5	5	6	6	6	6
N	6	8	8	8	8	10	10	10	10	12	12	12	12	14	14	14	14	16	16	16	16	18	18	18	18
Weight (kg)	7.4	7.8	8.2	8.6	9.0	9.4	9.8	10.1	10.5	10.9	11.3	11.7	12.1	12.5	12.9	13.3	13.7	14.1	14.5	14.9	15.3	15.7	16.1	16.5	16.9

Effective stroke	1400	1450	1500	1550	1600	1650	1700	1750	1800	1850	1900	1950	2000	2050	2100	2150	2200	2250	2300	2350	2400	2450	2500	2550
L	1710	1760	1810	1860	1910	1960	2010	2060	2110	2160	2210	2260	2310	2360	2410	2460	2510	2560	2610	2660	2710	2760	2810	2860
A	50	100	150	200	50	100	150	200	50	100	150	200	50	100	150	200	50	100	150	200	50	100	150	200
B	1320	1320	1320	1320	1320	1320	1320	1320	1320	1320	1320	1320	1320	1320	1320	1320	1320	1320	1320	1320	1320	1320	1320	1320
C	-	240	240	240	420	420	420	420	600	600	600	600	780	780	780	780	960	960	960	960	1140	1140	1140	1140
D	2	3	3	3	3	3	3	3	3	3	3	3	3	3	3	3	3	3	3	3	3	3	3	3
M	7	7	7	7	8	8	8	8	9	9	9	9	10	10	10	10	11	11	11	11	11	12	12	12
N	20	20	20	20	22	22	22	22	24	24	24	24	26	26	26	26	28	28	28	28	28	30	30	30
Weight (kg)	17.3	17.7	18.0	18.4	18.8	19.2	19.6	20.0	20.4	20.8	21.2	21.6	22.0	22.4	22.8	23.2	23.6	24.0	24.4	24.8	25.2	25.6	25.9	26.3

Note 1. Stop positions are determined by the mechanical stoppers at both ends.
Note 2. Cables can be extracted in upward, downward, forward or rearward directions. (This figure shows the forward direction.)

B10 RU type (Motor rightward, upper position)

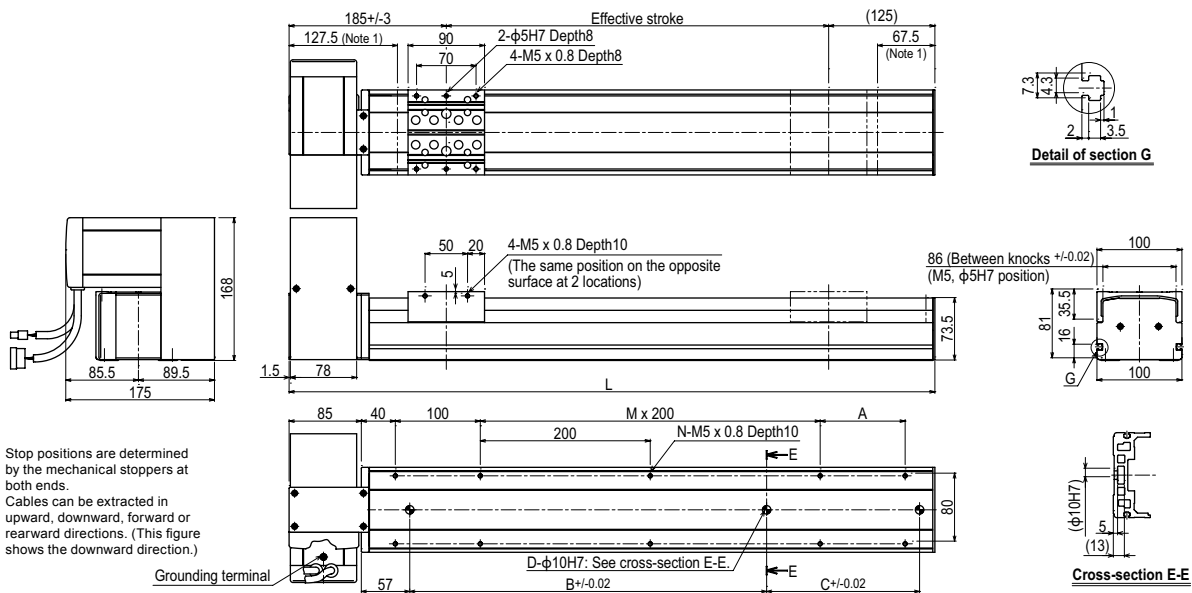

Note 1. Stop positions are determined by the mechanical stoppers at both ends.
Note 2. Cables can be extracted in upward, downward, forward or rearward directions. (This figure shows the downward direction.)

B10 RD type (Motor rightward, lower position)

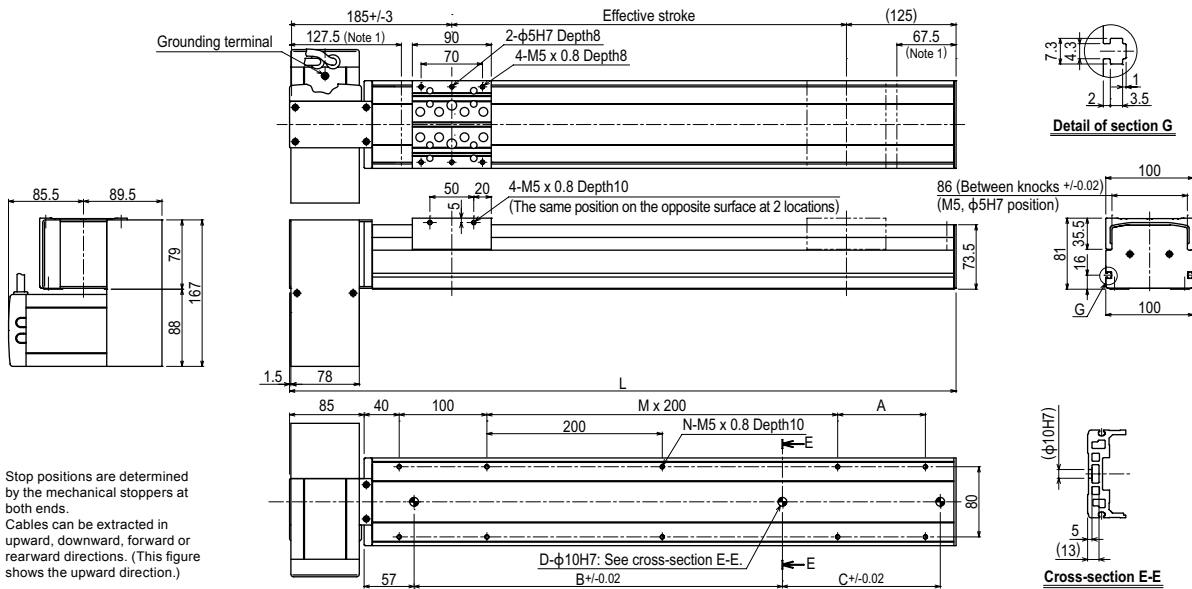

Note 1. Stop positions are determined by the mechanical stoppers at both ends.
Note 2. Cables can be extracted in upward, downward, forward or rearward directions. (This figure shows the upward direction.)

B10 LU type (Motor leftward, upper position)

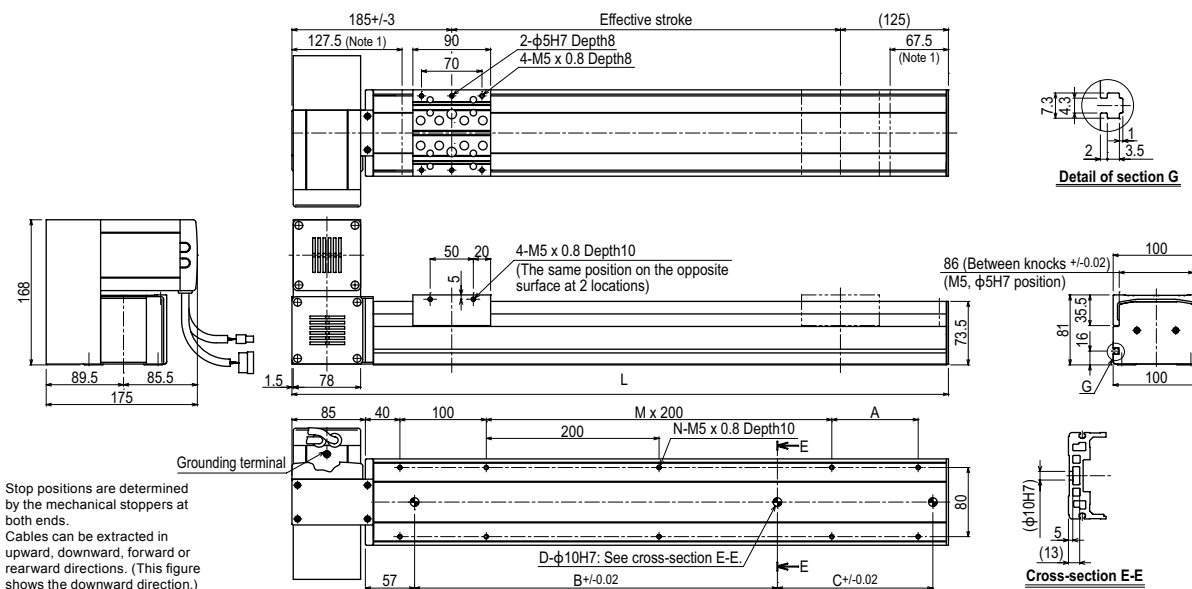

Note 1. Stop positions are determined by the mechanical stoppers at both ends.
Note 2. Cables can be extracted in upward, downward, forward or rearward directions. (This figure shows the downward direction.)

B14



Ordering method

B14

Model	Motor installation direction	Option	Stroke	Cable length ^{Note1}	Positioner ^{Note2}	Driver: Power supply voltage / Power capacity	LCD monitor	I/O selection	Battery
	L: Motor leftward, horizontal position R: Motor rightward, horizontal position LU: Motor leftward, upper position RU: Motor rightward, upper position LD: Motor leftward, lower position RD: Motor rightward, lower position	Grease type None: Standard GC: Clean	150 to 3050 (50mm pitch)	3L: 3.5m 5L: 5m 10L: 10m 3K/5K/10K (Flexible cable)	TS-X	105: 100V/100W or less 205: 200V/100W or less	No entry: None L: With LCD	NP: NPN PN: PNP CC: CC-Link DN: DeviceNet™ EP: EtherNet/IP™ PT: PROFINET GW: No I/O board ^{Note3}	B: With battery (Absolute) N: None (Incremental)

Controller	05	Usable for CE	I/O selection	Battery
SR1-X	Driver: Power capacity 05: 100W or less	No entry: Standard E: CE marking	N: NPN P: PNP CC: CC-Link DN: DeviceNet™ PB: PROFIBUS	B: With battery (Absolute) N: None (Incremental)

Driver	2	05	RBR1
RDV-X	Power supply voltage 2: AC200V	Driver: Power capacity 05: 100W or less	Regenerative unit

Note 1. The robot cable is standard cable (3L/5L/10L), but can be changed to flexible cable. See P.594 for details on robot cable.
 Note 2. See P.498 for DIN rail mounting bracket.
 Note 3. Select this selection when using the gateway function. For details, see P.60.

Specifications

AC servo motor output (W)	100
Repeatability ^{Note1} (mm)	+/-0.04
Belt (mm)	Equivalent to lead 25mm
Maximum speed (mm/sec)	1875
Maximum payload (kg)	20
Stroke (mm)	150 to 3050 (100mm pitch)
Overall length (mm)	Motor installation L/R type Stroke+425.5 Another Stroke+338
Maximum dimensions of cross section of main unit (mm)	W146 × H94
Cable length (m)	Standard: 3.5 / Option: 5.10
Linear guide type	4 rows of circular arc grooves × 2 rail
Position detector	Resolvers ^{Note2}
Resolution (Pulse/rotation)	16384

Note 1. Positioning repeatability in one direction.
 Note 2. Position detectors (resolvers) are common to incremental and absolute specifications. If the controller has a backup function then it will be absolute specifications.

Allowable overhang^{Note}

	Horizontal installation (Unit: mm)			Wall installation (Unit: mm)		
	A	B	C	A	B	C
5kg	2159	1228	943	1064	816	1468
10kg	1389	623	548	564	377	888
20kg	1102	320	348	305	156	615

Note. Distance from center of slider top to center of gravity of object being carried at a guide service life of 10,000 km.

Static loading moment

(Unit: N·m)		
MY	MP	MR
226	227	199

Controller

Controller	Operation method
SR1-X05 RCX221/222 RCX240/340	Programming / I/O point trace / Remote command / Operation using RS-232C communication
TS-X105 TS-X205	I/O point trace / Remote command
RDV-X205-RBR1	Pulse train control

Motor installation

The line-up consisting of six models of different motor installation position as follows.

L type Leftward at horizontal position	R type Rightward at horizontal position	LU type Leftward at upper position	RU type Rightward at upper position	LD type Leftward at lower position	RD type Rightward at lower position
---	--	---	--	---	--

B14 R type (Motor rightward, horizontal position)

Effective stroke (128)

297.5±.3

240 (Note 1)

90

70

32

2-φ6H7 Depth10

8-M6 x 1.0 Depth16

70.5 (Note 1)

167

4-M5 x 0.8 Depth12 (The same position on the opposite surface at 2 locations)

50

20

12.5

134 (Between knocks +/-0.02) (M6, φ6H7 position)

146

90.5

83

92

11

175

172.5

60

100

200

B x 200

A

M-M6 x 1.0 Depth10

100

φ10H7

5.5

18.5

Detail of section G

3.5

1.5

1.5

VIEW H

Grounding terminal

Cross-section J-J

Note 1. Stop positions are determined by the mechanical stoppers at both ends.
 Note 2. Cables can be extracted in upward, downward, forward or rearward directions. (This figure shows the forward direction.)

Effective stroke	150	200	250	300	350	400	450	500	550	600	650	700	750	800	850	900	950	1000	1050	1100	1150	1200	1250	1300	1350	1400	1450	1500	1550	1600
L	488	538	588	638	688	738	788	838	888	938	988	1038	1088	1138	1188	1238	1288	1338	1388	1438	1488	1538	1588	1638	1688	1738	1788	1838	1888	1938
M	6	8	8	8	8	10	10	10	10	12	12	12	12	14	14	14	16	16	16	16	16	18	18	18	18	20	20	20	20	22
A	-	50	100	150	200	50	100	150	200	50	100	150	200	50	100	150	200	50	100	150	200	50	100	150	200	50	100	150	200	50
B	1	1	1	1	1	2	2	2	2	3	3	3	3	4	4	4	5	5	5	5	5	6	6	6	6	7	7	7	7	8
C	240	240	240	420	420	420	600	600	600	600	780	780	780	780	960	960	960	1140	1140	1140	1140	1140	1140	1140	1140	1140	1140	1140	1140	1140
D	-	-	-	-	-	-	-	-	-	-	-	-	-	-	-	-	-	-	-	-	-	-	240	240	240	240	420	420	420	600
E	-	-	-	-	-	-	-	-	-	-	-	-	-	-	-	-	-	-	-	-	-	-	-	-	-	-	-	-	-	-
F	2	2	2	2	2	2	2	2	2	2	2	2	2	2	2	2	2	2	2	2	2	2	2	2	2	2	2	2	2	2
Weight (kg)	9.6	10.2	10.8	11.4	12	12.5	13.1	13.7	14.3	14.9	15.5	16.0	16.6	17.2	17.8	18.4	19	19.5	20.2	20.7	21.3	21.9	22.5	23.1	23.7	24.2	24.8	25.4	26	26.6

Effective stroke	1650	1700	1750	1800	1850	1900	1950	2000	2050	2100	2150	2200	2250	2300	2350	2400	2450	2500	2550	2600	2650	2700	2750	2800	2850	2900	2950	3000	3050	
L	1988	2038	2088	2138	2188	2238	2288	2338	2388	2438	2488	2538	2588	2638	2688	2738	2788	2838	2888	2938	2988	3038	3088	3138	3188	3238	3288	3338	3388	
M	22	22	22	24	24	24	24	26	26	26	26	28	28	28	28	30	30	30	30	32	32	32	32	34	34	34	34	36	36	
A	100	150	200	50	100	150	200	50	100	150	200	50	100	150	200	50	100	150	200	50	100	150	200	50	100	150	200	50	100	
B	8	8	8	9	9	9	9	10	10	10	10	11	11	11	11	12	12	12	12	13	13	13	13	14	14	14	14	15	15	
C	1140	1140	1140	1140	1140	1140	1140	1140	1140	1140	1140	1140	1140	1140	1140	1140	1140	1140	1140	1140	1140	1140	1140	1140	1140	1140	1140	1140	1140	1140
D	600	600	600	780	780	780	780	960	960	960	960	960	960	1140	1140	1140	1140	1140	1140	1140	1140	1140	1140	1140	1140	1140	1140	1140	1140	1140
E	-	-	-	-	-	-	-	-	-	-	-	-	-	-	-	-	-	-	-	-	-	-	-	-	-	-	-	-	-	-
F	3	3	3	3	3	3	3	3	3	3	3	3	3	3	3	3	3	3	3	3	3	3	3	3	3	3	3	3	3	3
Weight (kg)	27.2	27.7	28.3	28.9	29.5	30.1	30.7	31.3	31.9	32.4	33	33.6	34.2	34.8	35.4	35.9	36.5	37.1	37.7	38.3	38.9	39.4	40	40.6	41.2	41.8	42.4	43.0	43.6	

B14 RU type (Motor rightward, upper position)

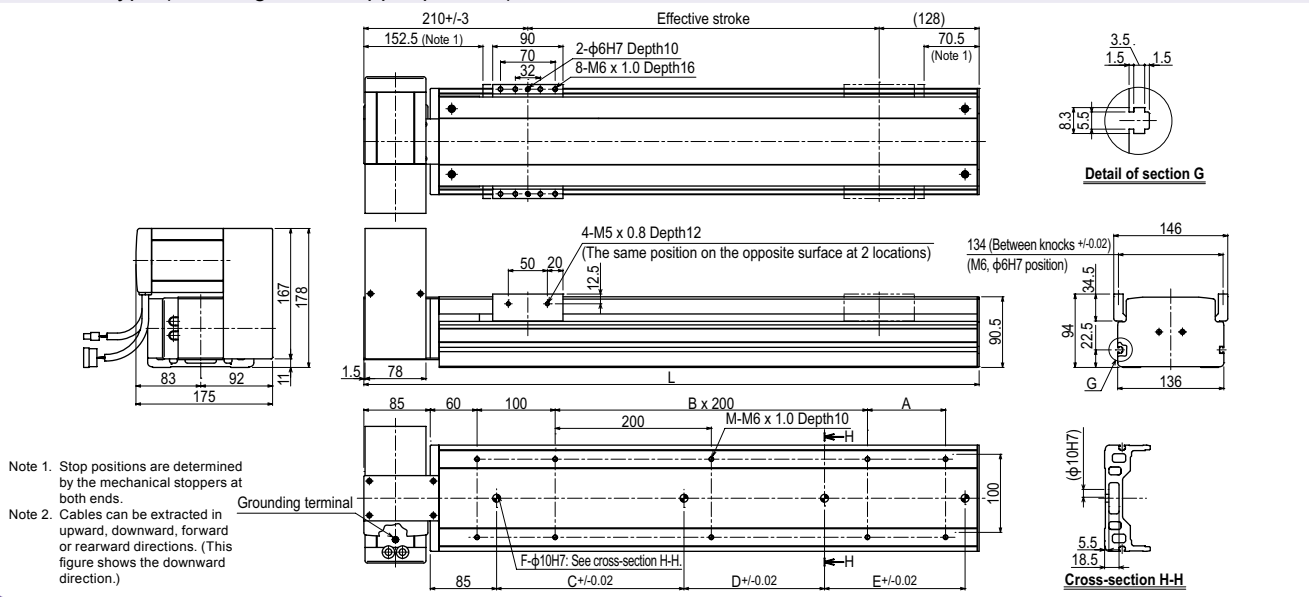

B14 RD type (Motor rightward, lower position)

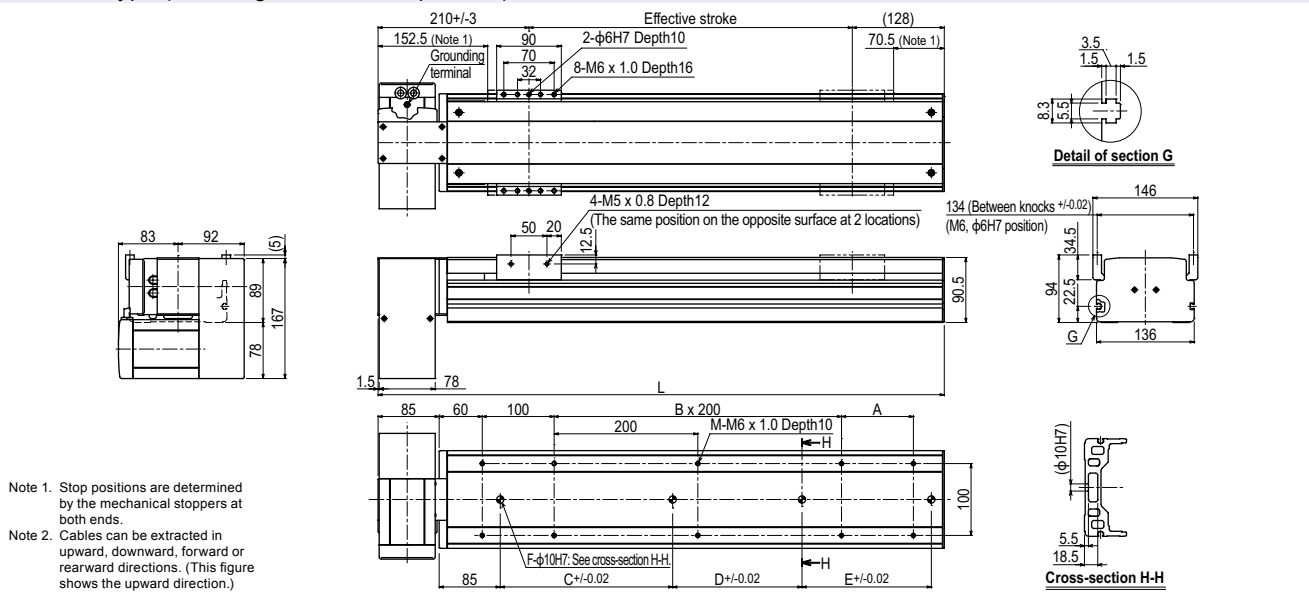

B14 LU type (Motor leftward, upper position)

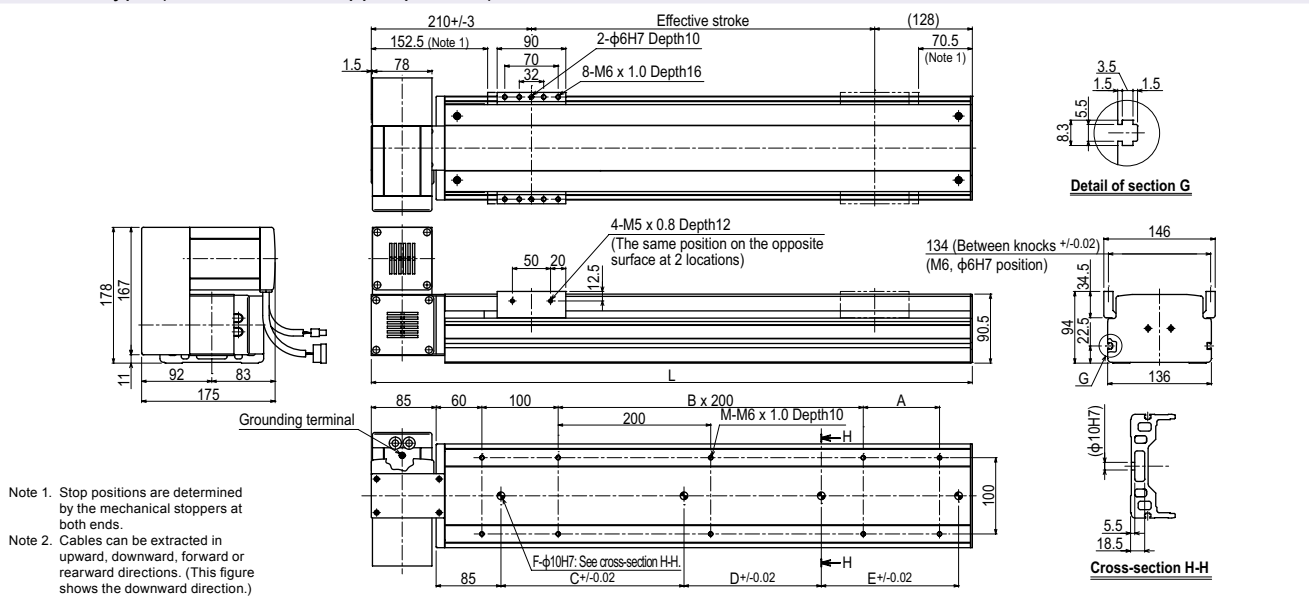

B14H



Ordering method

B14H	Motor installation direction	Option	Stroke	Cable length (mm)	TSX	R	LCD monitor	I/O selection	Battery	
Model	L: Motor leftward, horizontal position R: Motor rightward, horizontal position LU: Motor leftward, upper position RU: Motor rightward, upper position LD: Motor leftward, lower position RD: Motor rightward, lower position	Grease type None: Standard GC: Clean	150 to 3050 (60mm pitch)	3L: 3.5m 5L: 5m 10L: 10m 3K/5K/10K (Flexible cable)	Positioner TS-X	Driver: Power-supply voltage / Power capacity 105: 100V/100W or less 205: 200V/100W or less	Regenerative unit R: With RGT	No entry: None L: With LCD	N: NPN PN: PNP CC: CC-Link DN: DeviceNet™ EP: EtherNet/IP™ PT: PROFINET GW: No I/O board ^{Note 3}	B: With battery (Absolute) N: None (Incremental)
					SR1-X	05	R	I/O selection	Battery	
					Controller	Driver: Power capacity 05: 100W or less	Usable for CE No entry: Standard E: CE marking	N: NPN P: PNP CC: CC-Link DN: DeviceNet™ PB: PROFIBUS	B: With battery (Absolute) N: None (Incremental)	
					RDV-X	2	10	RBR1	Regenerative unit	
					Driver	Power-supply voltage 2: AC200V	Driver: Power capacity 10: 200W or less			

Note 1. The robot cable is standard cable (3L/5L/10L), but can be changed to flexible cable. See P.594 for details on robot cable.
Note 2. See P.498 for DIN rail mounting bracket.
Note 3. Select this selection when using the gateway function. For details, see P.60.

Specifications

AC servo motor output (W)	200
Repeatability ^{Note 1} (mm)	+/-0.04
Belt (mm)	Equivalent to lead 25mm
Maximum speed (mm/sec)	1250 (1875 ^{Note 2})
Maximum payload (kg)	30
Stroke (mm)	150 to 3050(100mm pitch)
Overall length (mm)	Motor installation L/R type Another Stroke+475.5 Stroke+388
Maximum dimensions of cross section of main unit (mm)	W146 × H94
Cable length (m)	Standard: 3.5 / Option: 5,10
Linear guide type	4 rows of circular arc grooves × 2 rail
Position detector	Resolvers ^{Note 3}
Resolution (Pulse/rotation)	16384

Note 1. Positioning repeatability in one direction.
Note 2. A regenerative unit is needed if using the SR1-X, TS-X at maximum speeds exceeding 1250mm/sec. If using the RDV-X, then the regenerative unit RBR1 is required regardless of the installation conditions.
Note 3. Position detectors (resolvers) are common to incremental and absolute specifications. If the controller has a backup function then it will be absolute specifications.

Allowable overhang^{Note}

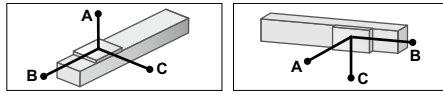

	Horizontal installation (Unit: mm)			Wall installation (Unit: mm)		
	A	B	C	A	B	C
5kg	3000	3000	1941	2074	2585	3000
10kg	2742	1697	1064	1087	1236	2071
20kg	2158	867	651	604	561	1512
30kg	1708	590	466	397	336	1106

Note. Distance from center of slider top to center of gravity of object being carried at a guide service life of 10,000 km.

Static loading moment

			(Unit: N·m)
MY	MP	MR	
610	555	488	

Controller

Controller	Operation method
SR1-X05 ^{Note} RCX221/222 RCX240/340	Programming / I/O point trace / Remote command / Operation using RS-232C communication
TS-X105 ^{Note} TS-X205 ^{Note}	I/O point trace / Remote command
RDV-X210-RBR1	Pulse train control

Note. A regenerative unit is needed if using the SR1-X, TS-X at maximum speeds exceeding 1250mm/sec.

Motor installation The line-up consisting of six models of deferent motor installation position as follows.

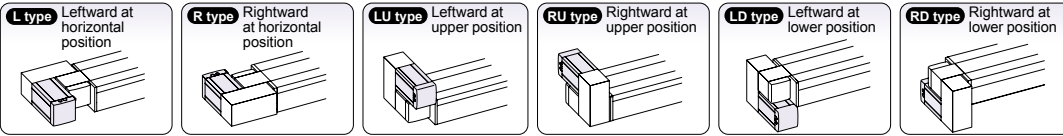

B14H R type (Motor rightward, horizontal position)

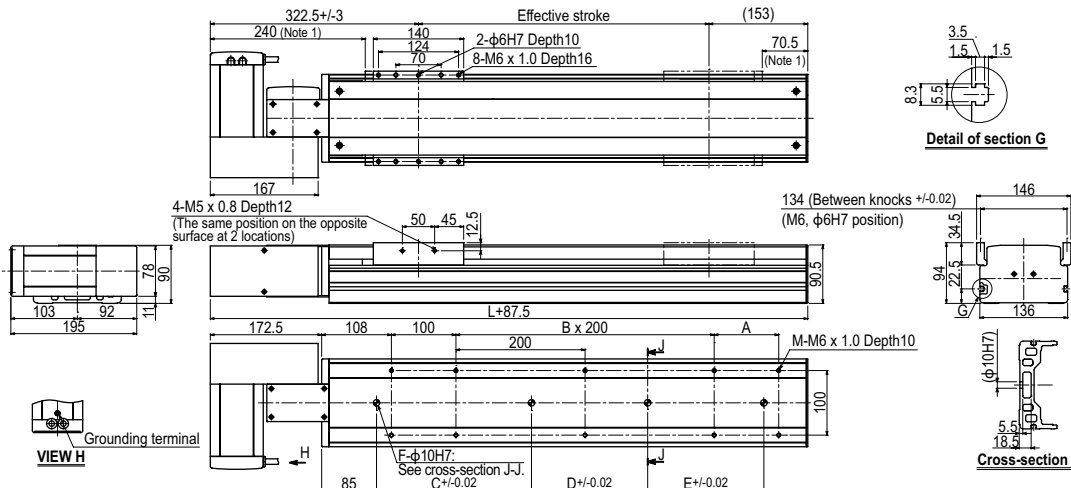

Note 1. Stop positions are determined by the mechanical stoppers at both ends.
Note 2. Cables can be extracted in upward, downward, forward or rearward directions. (This figure shows the forward direction.)

Effective stroke	150	200	250	300	350	400	450	500	550	600	650	700	750	800	850	900	950	1000	1050	1100	1150	1200	1250	1300	1350	1400	1450	1500	1550	1600
L	538	588	638	688	738	788	838	888	938	988	1038	1088	1138	1188	1238	1288	1338	1388	1438	1488	1538	1588	1638	1688	1738	1788	1838	1888	1938	1988
M	6	8	8	8	8	10	10	10	12	12	12	14	14	14	14	16	16	16	16	16	16	18	18	18	18	20	20	20	20	22
A	-	50	100	150	200	50	100	150	200	50	100	150	200	50	100	150	200	50	100	150	200	50	100	150	200	50	100	150	200	50
B	1	1	1	1	2	2	2	2	3	3	3	4	4	4	4	5	5	5	5	5	5	6	6	6	7	7	7	7	8	
C	240	240	420	420	420	600	600	600	600	780	780	780	780	960	960	960	1140	1140	1140	1140	1140	1140	1140	1140	1140	1140	1140	1140	1140	1140
D	-	-	-	-	-	-	-	-	-	-	-	-	-	-	-	-	-	-	-	-	-	240	240	240	240	420	420	420	600	600
E	-	-	-	-	-	-	-	-	-	-	-	-	-	-	-	-	-	-	-	-	-	-	-	-	-	-	-	-	-	-
F	2	2	2	2	2	2	2	2	2	2	2	2	2	2	2	2	2	2	2	2	2	2	2	2	2	2	2	2	2	2
Weight (kg)	10.9	11.5	12.1	12.7	13.2	13.9	14.4	15.0	15.6	16.2	16.7	17.4	17.9	18.5	19.1	19.7	20.2	20.9	22.0	22.1	22.6	23.3	23.8	24.4	24.9	25.6	26.1	26.8	27.3	27.9
Effective stroke	1650	1700	1750	1800	1850	1900	1950	2000	2050	2100	2150	2200	2250	2300	2350	2400	2450	2500	2550	2600	2650	2700	2750	2800	2850	2900	2950	3000	3050	
L	2038	2088	2138	2188	2238	2288	2338	2388	2438	2488	2538	2588	2638	2688	2738	2788	2838	2888	2938	2988	3038	3088	3138	3188	3238	3288	3338	3388	3438	
M	22	22	22	24	24	24	24	26	26	26	26	28	28	28	28	30	30	30	30	32	32	32	32	34	34	34	34	36	36	
A	100	150	200	50	100	150	200	50	100	150	200	50	100	150	200	50	100	150	200	50	100	150	200	50	100	150	200	50	100	
B	8	8	8	9	9	9	9	10	10	10	10	11	11	11	11	12	12	12	12	13	13	13	13	14	14	14	14	15	15	
C	1140	1140	1140	1140	1140	1140	1140	1140	1140	1140	1140	1140	1140	1140	1140	1140	1140	1140	1140	1140	1140	1140	1140	1140	1140	1140	1140	1140	1140	1140
D	600	600	780	780	780	960	960	960	1140	1140	1140	1140	1140	1140	1140	1140	1140	1140	1140	1140	1140	1140	1140	1140	1140	1140	1140	1140	1140	1140
E	-	-	-	-	-	-	-	-	-	-	-	-	-	-	-	240	240	240	240	240	240	240	240	420	420	420	420	420	420	
F	3	3	3	3	3	3	3	3	3	3	3	3	3	3	3	3	3	3	3	3	3	3	3	3	3	3	3	3	3	
Weight (kg)	28.4	29.1	29.6	30.3	30.8	31.4	31.9	32.6	33.1	33.8	34.3	35.0	35.5	36.1	36.6	37.3	37.8	38.5	39.0	39.6	40.1	40.8	41.3	42.0	42.5	43.1	43.6	44.3	45.4	

B14H RU type (Motor rightward, upper position)

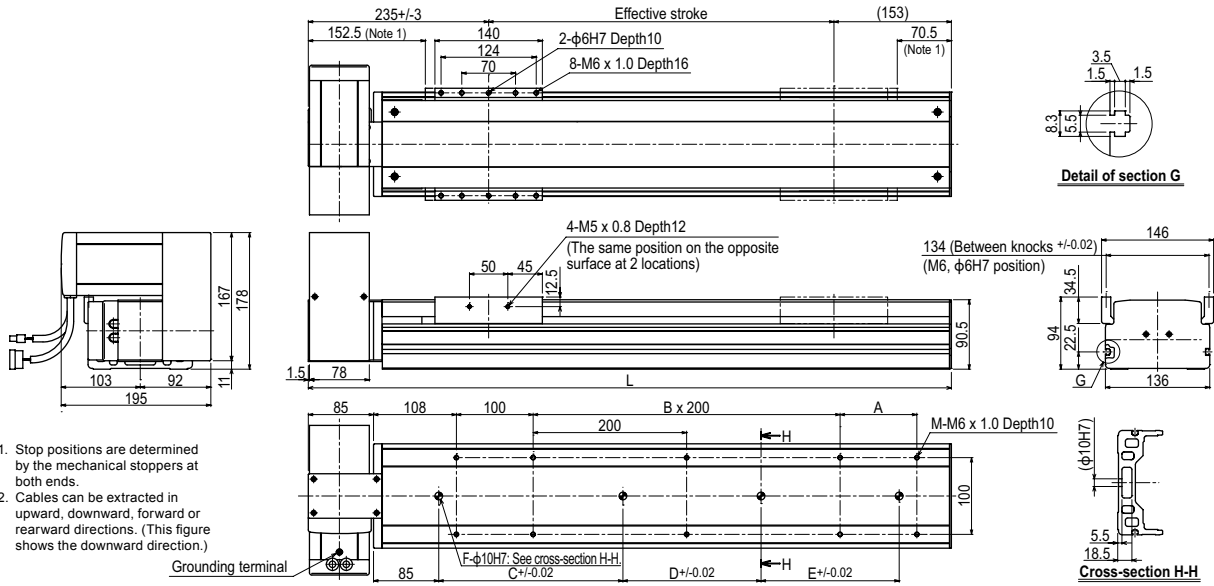

B14H RD type (Motor rightward, lower position)

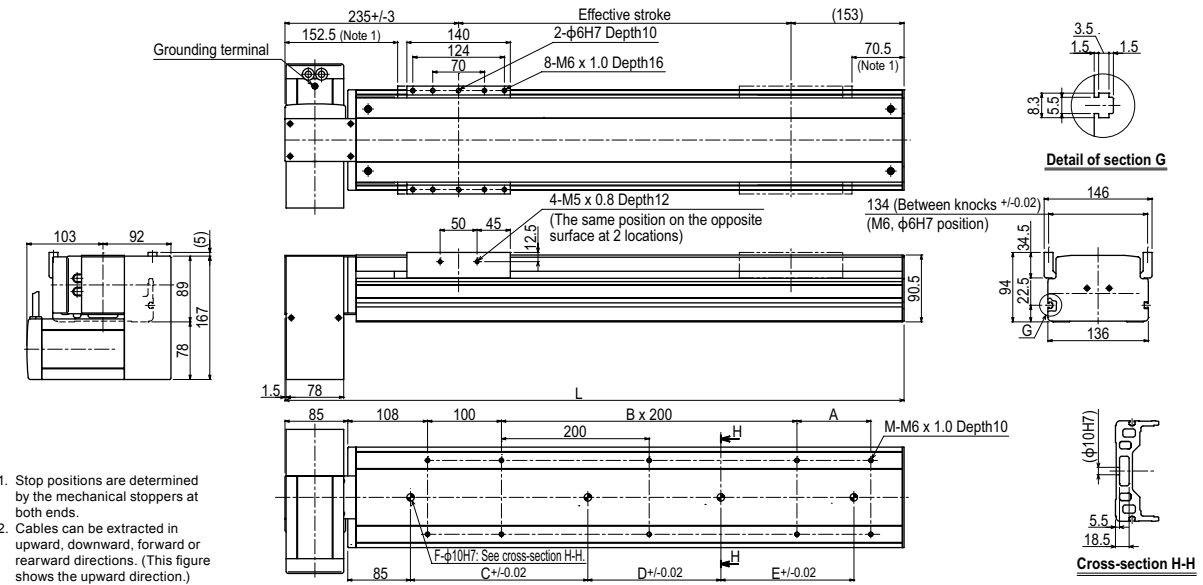

B14H LU type (Motor leftward, upper position)

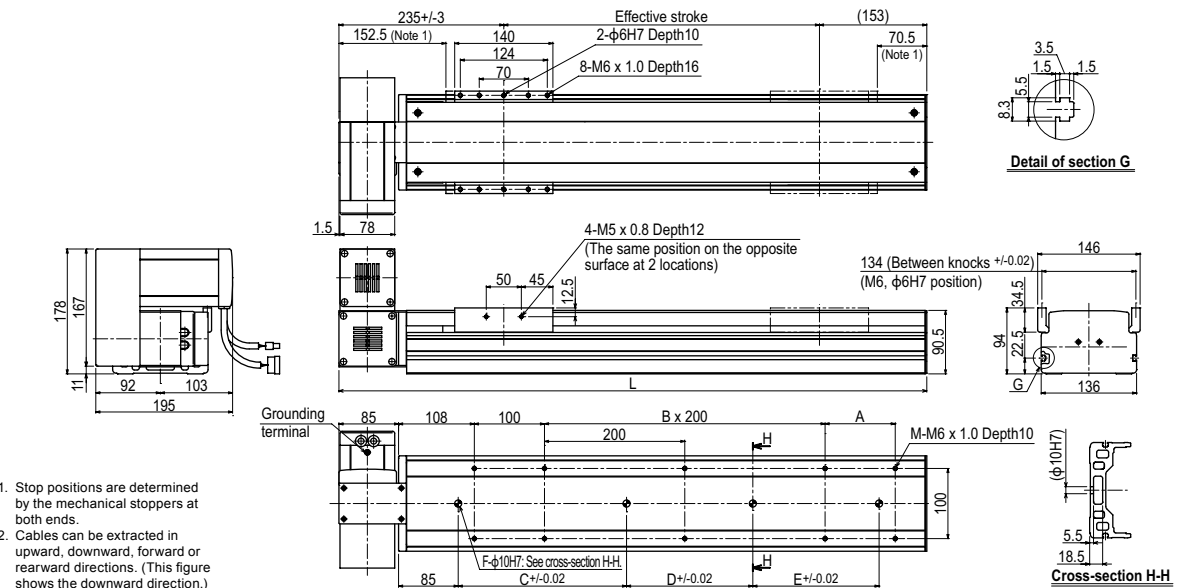

R5



Ordering method

R5

Model	Cable entry location	Cable length ^{Note 1}
	No entry: Standard (S) B: From the side	3L: 3.5m 5L: 5m 10L: 10m 3K/5K/10K (Flexible cable)

TSX

Positioner ^{Note 2}	Driver: Power-supply voltage / Power capacity	LCD monitor	I/O selection	Battery
TS-X	105: 100V/100W or less 205: 200V/100W or less	No entry: None L: With LCD	NP: NPN PN: PNP CC: CC-Link DN: DeviceNet™ EP: EtherNet/IP™ PT: PROFINET GW: No I/O board ^{Note 3}	B: With battery (Absolute) N: None (Incremental)

SR1-X

Controller	05	Usable for CE	I/O selection	Battery
	Driver: Power capacity 05: 100W or less	No entry: Standard E: CE marking	N: NPN P: PNP CC: CC-Link DN: DeviceNet™ PB: PROFIBUS	B: With battery (Absolute) N: None (Incremental)

RDV-X

Driver	2	05	RBR1
	Power-supply voltage 2: AC200V	Driver: Power capacity 05: 100W or less	Regenerative unit

Note 1. The robot cable is standard cable (3L/5L/10L), but can be changed to flexible cable. See P.594 for details on robot cable.
Note 2. See P.498 for DIN rail mounting bracket.
Note 3. Select this selection when using the gateway function. For details, see P.60.

Specifications

AC servo motor output (W)	50
Repeatability (°)	+/-0.0083
Maximum speed (°/sec)	360
Maximum allowable moment inertia (kgm ² [kgfcm ²])	0.12 [1.2]
Rated torque (Nm[kgfm])	5.29 [0.54]
Speed reduction ratio	1/50
Rotation range (°)	360
Cable length (m)	Standard: 3.5 / Option: 5.10
Speed reducer type	Harmonic drive
Position detector	Resolvers
Resolution (Pulse/rotation)	16384

Maximum allowable moment inertia

Payload parameters W (kg)	1	2	3	4	5	6	7	8	9	10
Maximum allowable moment inertia J (kgfcm ²)	0.12	0.24	0.36	0.48	0.60	0.72	0.84	0.96	1.08	1.20

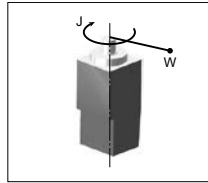

Note. When the weight of a tool or workpiece attached to the shaft R5 is W (kg), its moment of inertia (J) must be smaller than the values shown in the table above. (For example, enter 4kg if W is 3kg and J is 0.48kgf cm sec²) Enter the above mass parameter value for the controller, and optimum acceleration is automatically set based on this value.

Note. For calculation (equation) of the inertia moment, please refer to P.611.

Controller

Controller	Operation method
SR1-X05 RCX221/222 RCX240/340	Programming / I/O point trace / Remote command / Operation using RS-232C communication
TS-X105	I/O point trace / Remote command
TS-X205	Remote command
RDV-X205-RBR1	Pulse train control

R5

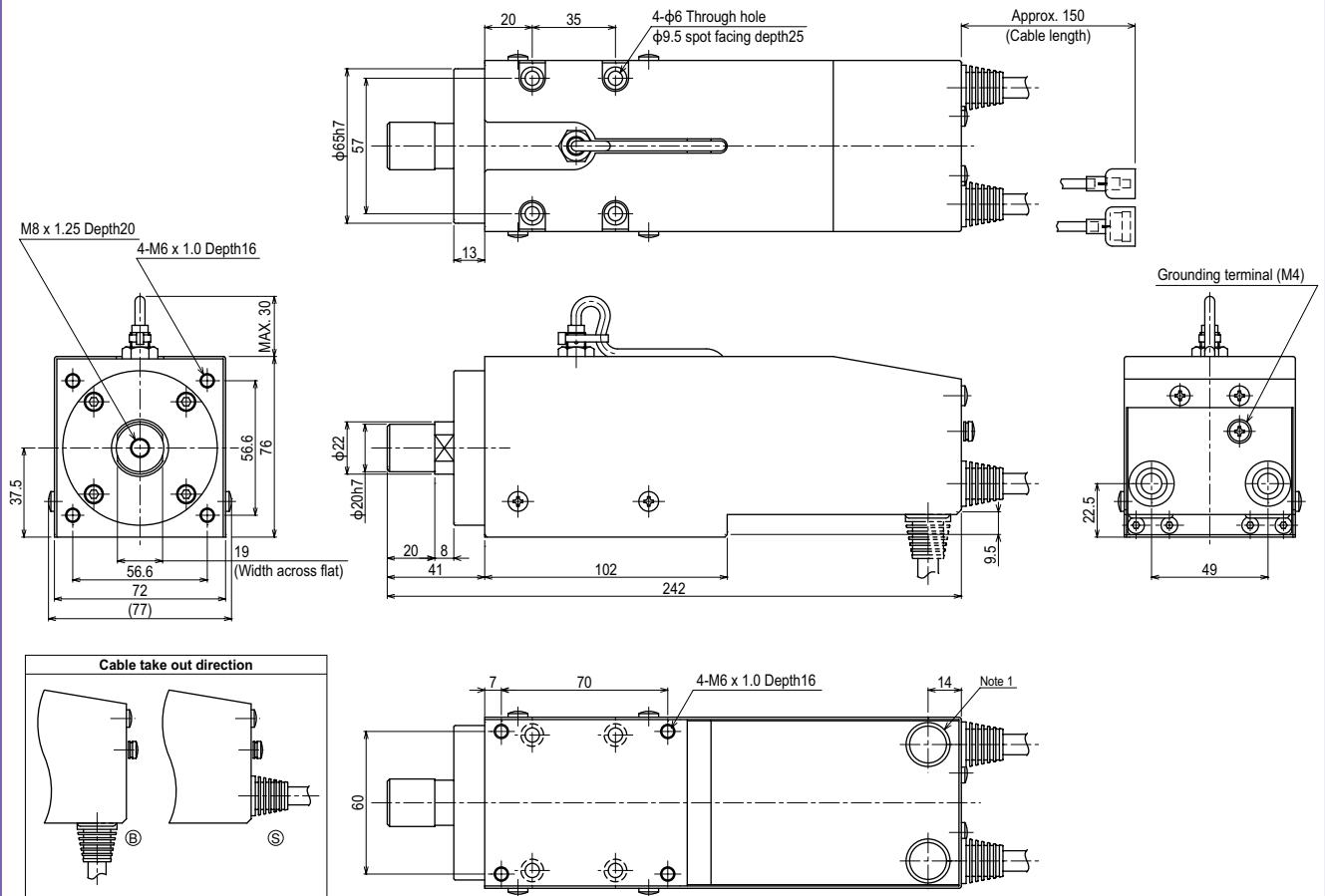

Weight (kg) 3.0 Note 1. The cable extraction port can be changed.

R10



Ordering method

R10	Model	Cable entry location No entry: Standard (S) B: From the side	Cable length <small>Note 1</small> 3L: 3.5m 5L: 5m 10L: 10m 3K/5K/10K (Flexible cable)	TSX	Positioner <small>Note 2</small> TS-X	Driver: Power-supply voltage / Power capacity 105: 100V/100W or less 205: 200V/100W or less	LCD monitor No entry: None L: With LCD	I/O selection NP: NPN PN: PNP CC: CC-Link DN: DeviceNet™ EP: EtherNet/IP™ PT: PROFINET GW: No I/O board <small>Note 3</small>	Battery B: With battery (Absolute) N: None (Incremental)
	SR1-X	Controller	05	Driver: Power capacity 05: 100W or less	Usable for CE No entry: Standard E: CE marking	I/O selection N: NPN P: PNP CC: CC-Link DN: DeviceNet™ PB: PROFIBUS	Battery B: With battery (Absolute) N: None (Incremental)		
	RDV-X	Driver	2	Power-supply voltage 2: AC200V	05	Driver: Power capacity 05: 100W or less	RBR1	Regenerative unit	

Note 1. The robot cable is standard cable (3L/5L/10L), but can be changed to flexible cable.
See P.594 for details on robot cable.
Note 2. See P.498 for DIN rail mounting bracket.
Note 3. Select this selection when using the gateway function. For details, see P.60.

Specifications

AC servo motor output (W)	100
Repeatability (°)	+/-0.0083
Maximum speed (°/sec)	360
Maximum allowable moment inertia (kgm ² [kgfcm ²])	0.36 [3.71]
Rated torque (Nm[kgfm])	10.78 [1.10]
Speed reduction ratio	1/50
Rotation range (°)	360
Cable length (m)	Standard: 3.5 / Option: 5,10
Speed reducer type	Harmonic drive
Position detector	Resolvers
Resolution (Pulse/rotation)	16384

Maximum allowable moment inertia

Payload parameters W (kg)	1	2	3	4	5	6	7	8	9	10
Maximum allowable moment inertia J (kgfcm ²)	0.25	0.49	0.74	0.99	1.24	1.48	1.73	1.98	2.23	2.47
Payload parameters W (kg)	11	12	13	14	15					
Maximum allowable moment inertia J (kgfcm ²)	2.72	2.97	3.22	3.46	3.71					

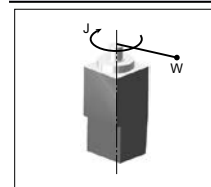

Note. When the weight of a tool or workpiece attached to the shaft R10 is W (kg), its moment of inertia (J) must be smaller than the values shown in the table above. (For example, enter 4kg if W is 3kg and J is 0.99kgf cm sec².) Enter the above mass parameter value for the controller, and optimum acceleration is automatically set based on this value.

Note. For calculation (equation) of the inertia moment, please refer to P.611.

Controller

Controller	Operation method
SR1-X05 RCX221/222 RCX240/340	Programming / I/O point trace / Remote command / Operation using RS-232C communication
TS-X105	I/O point trace / Remote command
TS-X205	Remote command
RDV-X205-RBR1	Pulse train control

R10

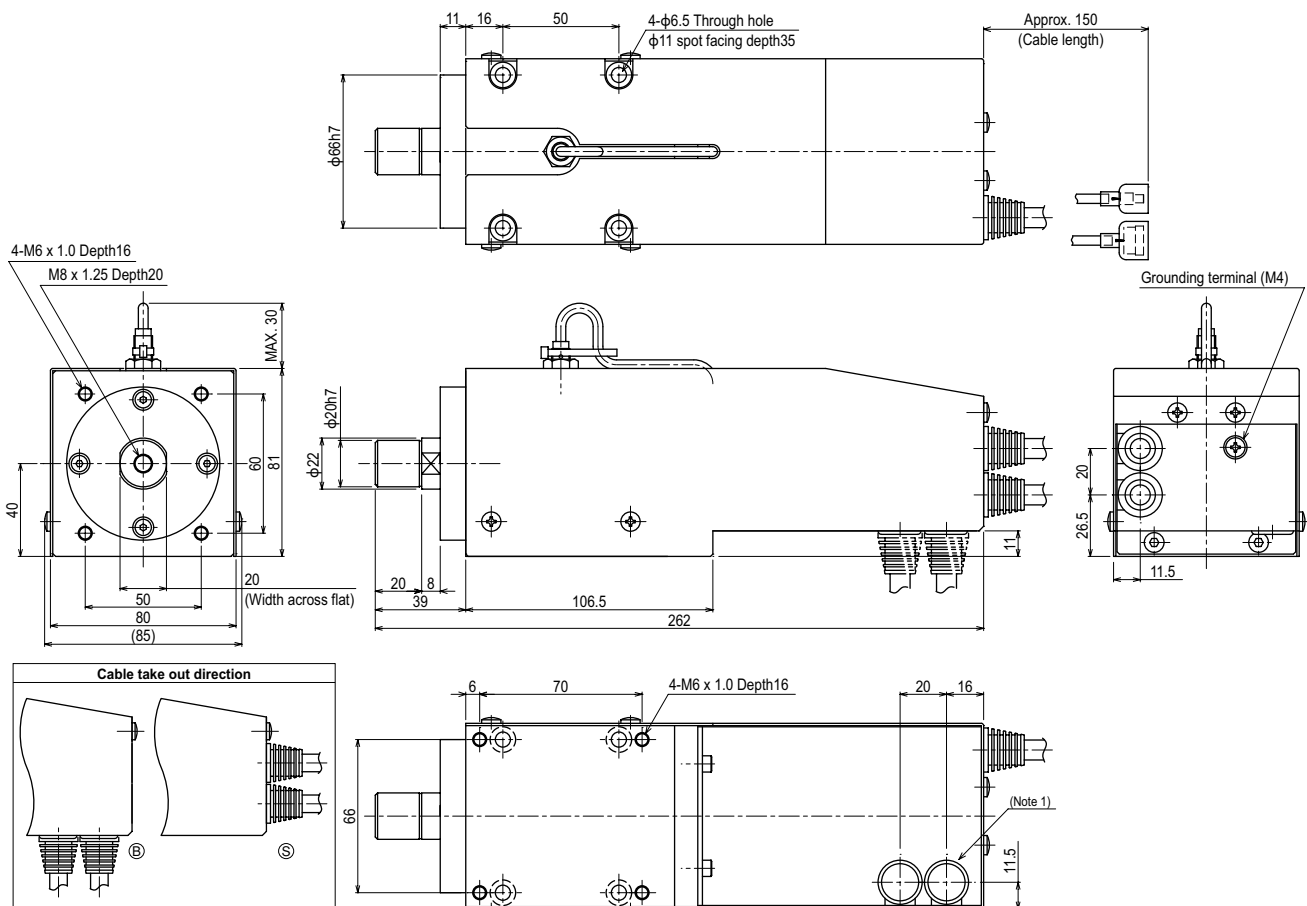

Weight (kg) 3.5 Note 1. The cable extraction port can be changed.

Articulated robots
YA

Linear conveyor modules
LCM100

Compact single-axis robots
TRANSEVO

Single-axis robots
FLIP-X

Linear motor single-axis robots
PHASER

Cartesian robots
XY-X

SCARA robots
YK-X

Pick & place robots
YP-X

CLEAN

CONTROLLER INFORMATION

T type

F type

GF type

N type

R type

R20



Ordering method

R20	Model	Cable entry location No entry: Standard (S) B: From the side	Cable length ^{Note 1} 3L: 3.5m 5L: 5m 10L: 10m 3K/5K/10K (Flexible cable)	TSX	Positioner ^{Note 2} TS-X	Driver: Power-supply voltage / Power capacity 110: 100V/200W or less 210: 200V/200W or less	LCD monitor No entry: None L: With LCD	I/O selection NP: NPN PN: PNP CC: CC-Link DN: DeviceNet™ EP: EtherNet/IP™ PT: PROFINET GW: No I/O board ^{Note 3}	Battery B: With battery (Absolute) N: None (Incremental)
	SR1-X	Controller	10	Driver: Power capacity 10: 200W or less	Usable for CE No entry: Standard E: CE marking	I/O selection N: NPN P: PNP CC: CC-Link DN: DeviceNet™ PB: PROFIBUS	Battery B: With battery (Absolute) N: None (Incremental)		
	RDV-X	Driver	2	Power-supply voltage 2: AC200V	10	Driver: Power capacity 10: 200W or less	RBR1	Regenerative unit	

Note 1. The robot cable is standard cable (3L/5L/10L), but can be changed to flexible cable.
See P.594 for details on robot cable.
Note 2. See P.498 for DIN rail mounting bracket.
Note 3. Select this selection when using the gateway function. For details, see P.60.

Specifications

AC servo motor output (W)	200
Repeatability (°)	+/-0.0083
Maximum speed (°/sec)	360
Maximum allowable moment inertia (kgm²[kgfcm²])	1.83 [18.7]
Rated torque (Nm[kgfm])	21.46 [2.19]
Speed reduction ratio	1/50
Rotation range (°)	360
Cable length (m)	Standard: 3.5 / Option: 5,10
Speed reducer type	Harmonic drive
Position detector	-
Resolution (Pulse/rotation)	16384

Maximum allowable moment inertia

Payload parameters W (kg)	1	2	3	4	5	6	7	8	9	10
Maximum allowable moment inertia J (kgfcm²)	0.93	1.8	2.8	3.7	4.6	5.6	6.5	7.4	8.4	9.3
Payload parameters W (kg)	11	12	13	14	15	16	17	18	19	20
Maximum allowable moment inertia J (kgfcm²)	10.2	11.2	12.1	13.1	14	14.9	15.9	16.8	17.7	18.7

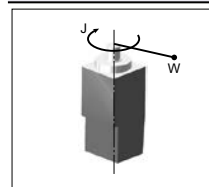

Note. When the weight of a tool or workpiece attached to the shaft R20 is W (kg), its moment of inertia (J) must be smaller than the values shown in the table above. (For example, enter 4kg if W is 3kg and J is 3.7kgf cm sec².) Enter the above mass parameter value for the controller, and optimum acceleration is automatically set based on this value.

Note. For calculation (equation) of the inertia moment, please refer to P.611.

Controller

Controller	Operation method
SR1-X10 RCX221/222 RCX240/340	Programming / I/O point trace / Remote command / Operation using RS-232C communication
TS-X110	I/O point trace / Remote command
TS-X210	Remote command
RDV-X210-RBR1	Pulse train control

R20

Weight (kg) 5.5

Note 1. The cable extraction port can be changed.