

PHASER Series

Product Lineup

LINEAR MOTOR SINGLE-AXIS ROBOTS

No limit on critical speed even when using a long stroke of 4 m.
"PHASER" series delivers superb performance
during long distance transfer.



Critical speed is not restricted and high-speed long-stroke transfer is possible.

MF type

High-power and long-stroke using flat motor with core

P.242

- Maximum stroke: 4050 mm
- Maximum speed: 2500 mm/s
- Repeated positioning accuracy: +/-5 μm
- Maximum payload: 7 to 160 kg

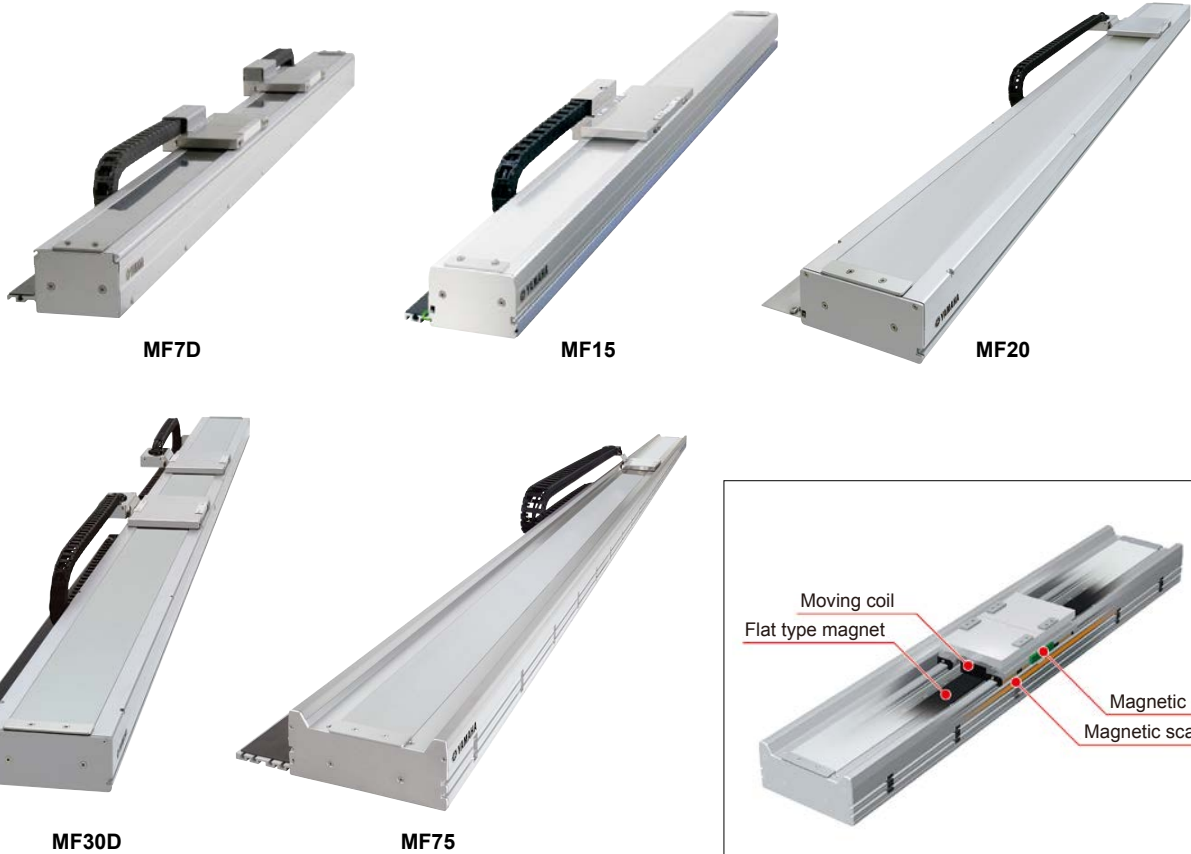

Type	Size (mm) ^{Note 1}	Model	Carrier	Maximum payload (kg)	Maximum speed (mm/sec.)	Stroke (mm)	Page
MF type Flat type with core Linear motor specifications	W85 × H80	MF7	Single	10 (7) ^{Note 2}	2500	100 to 4000	P.242
		MF7D	Double			100 to 3800	
	W100 × H80	MF15	Single	30 (15) ^{Note 2}		100 to 4000	P.248
		MF15D	Double			100 to 3800	
	W150 × H80	MF20	Single	40 (20) ^{Note 2}		150 to 4050	P.252
		MF20D	Double			150 to 3850	
		MF30	Single	60 (30) ^{Note 2}		100 to 4000	P.255
		MF30D	Double			150 to 3750	
	W210 × H100	MF75	Single	160 (75) ^{Note 2}		1000 to 4000	P.258
		MF75D	Double			680 to 3680	

Note 1. The size shows approximate maximum cross sectional size.

Note 2. When using at the maximum speed, the maximum payload becomes the value in ().

POINT 1

Maximum speed 2.5 m/sec. and no critical speed limit

The linear motor single-axis robot has no restrictions on critical speed like ball screw. The maximum stroke is 4 m. The long-distance transfer reduces the cycle time greatly.

Movement time comparison between linear single-axis robot PHASER and single-axis robot FLIP-X

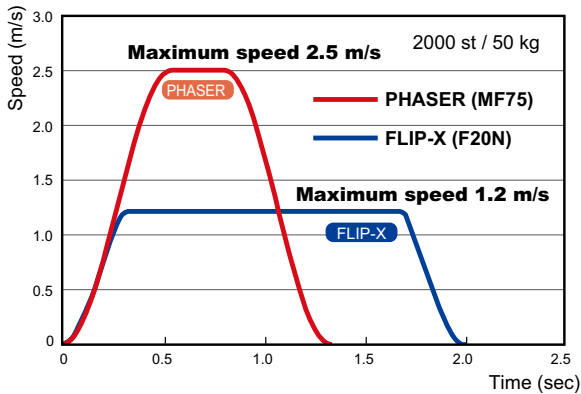

POINT 2

Suitable for heavy object transfer. Maximum payload 160 kg

The maximum payload is 160 kg. The robot can transfer a heavy object, such as large LCD panel at a high speed with high accuracy. (In the payload range of some MF types, the maximum speed may be restricted. For details, refer to the specification page of each model.)

POINT 3

Effective use of stroke

As the linear motor single-axis robot incorporates a coil that is the drive part inside the table, dead spaces are eliminated to maximize the stroke. Additionally, as the main body is symmetrical, the flexibility of the layout is improved.



POINT 4

In-house manufacturing of major parts achieves low costs.

Magnetic scales are developed and manufactured at YAMAHA. In-house manufacturing of other major parts achieves large cost reduction. Nowadays, the linear motor is not a special mechanism. The customer can select the linear motor or ball screw in the similar way according to the customer's needs. In particular, when performing a high-speed and long-distance transfer of a light workpiece, selecting linear motor robots may reduce the cost.

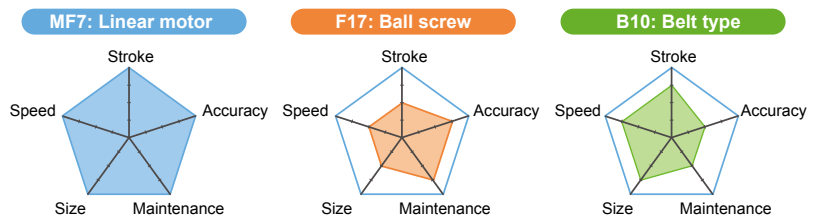

Comparison of single-axis robot models

Model name	Main body price ^{Note 1}	Maximum speed (mm/sec.)	Maximum payload (kg)	Repeated positioning accuracy (μm)	Maximum stroke (mm)	Maximum cross-sectional dimension ^{Note 2} (mm)
MF7-1500		2500	10 (7) ^{Note 3}	+/- 5	4000	W85 × H80
F17-40-1450		720 ^{Note 4}	40	+/- 10	1450	W168 × H100
B10-1450		1850	10	+/- 40	2550	W100 × H81

Note 1: The prices are compared with the strokes shown above.
 Note 2: Cable carriers are not included.
 Note 3: The payload is 7 kg when the maximum speed is 2500 mm/s. (10 kg-payload: 2100 mm/s)
 Note 4: This value is obtained by considering the critical speed with a stroke of 1450 mm.

POINT 5

Double-carrier available as standard

Double-carrier specifications that operate two carriers on one robot are available as standard. High effects, such as space saving, cost reduction, and tact improvement are obtained when compared to two single-axis robots. Furthermore, no axis alignment is needed and tools are commonly used to shorten the setup time. (When using the RCX series controller, an anti-collision function can be used.)

Layout using two ball screw single-axis robots

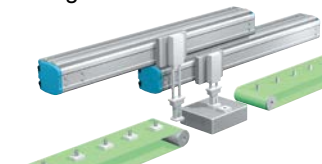

Space saving using double-carrier

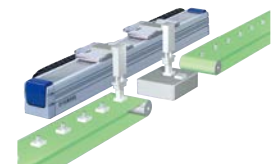

POINT 6

Linear scale developed by YAMAHA

YAMAHA originally developed a new linear scale based on its excellent magnetic signal detection technology.



Magnetic scale provides high environment resistance.

YAMAHA's magnetic scale is resistant to dirt and can be used in an environment where grease or cutting fluid sometimes splashes.

Semi-absolute specifications

The current position is obtained by reading the signal recorded in the linear scale. So, it is not necessary to perform a large return-to-origin movement before starting the operation after turning on the power (the slider moves up to 76 mm when reading the signals).

Cost reduction

In-house linear scale development and manufacturing achieves large cost reduction.

High resolution 1 μm

Magnetic signals recorded in the magnetic scale are detected and interpolated to achieve a highly accurate resolution of 1 μm .

Repeated positioning accuracy: $\pm 5 \mu\text{m}$

A fully-closed control that always feeds back the table position provides high accuracy steadily.

Additionally, there are no mechanical backlashes, such as ball screws or timing belts.

POINT 7

Silence and long service life

Unlike ball screw type robots, there are few sliding and rotating parts. So, the operation is very quiet. Moreover, as the coil is not in contact with the magnet, they are not worn out and can be used for an extended period of time.

POINT 8

Dust-proof structure

All YAMAHA's linear motor robots use a stainless steel shutter. This prevents entry of foreign objects. Additionally, these shutters are made of tough stainless steel with an extremely high fatigue strength to support high-speed and long-stroke operation.

POINT 9

Flat type without cable carrier protrusion

For the MF7, as the main body is made compact, a flat type that the cable carrier becomes flat on the top surface of the table is prepared as standard. Please select this type according to the tool or workpiece shape, or installation method.

Standard type

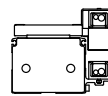

Flat type

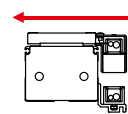

As the cable carrier does not protrude from the table upper surface in the flat type, a large tool can be installed easily.



Applicable to multi-carrier operation

The PHASER series also supports "multi-carrier" operation that allows using three or more carriers on one robot. This "multi-carrier" operation drastically extends applications due to its high effect in improving tact time and saving space.

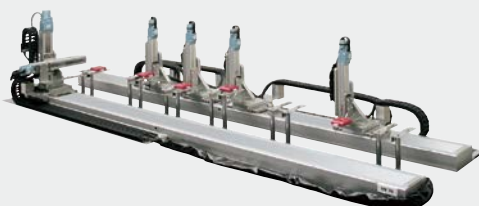

Applicable to dual-drive

As a dual-drive that simultaneously drives two axes, high-speed transfer and heavy object transfer are possible in a wide area. YAMAHA can propose an optimal control method according to the robot linkage rigidity.

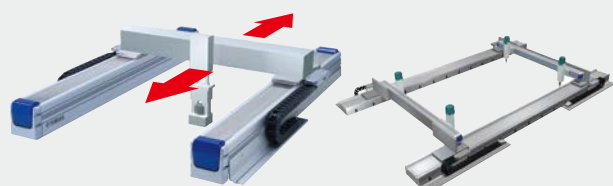

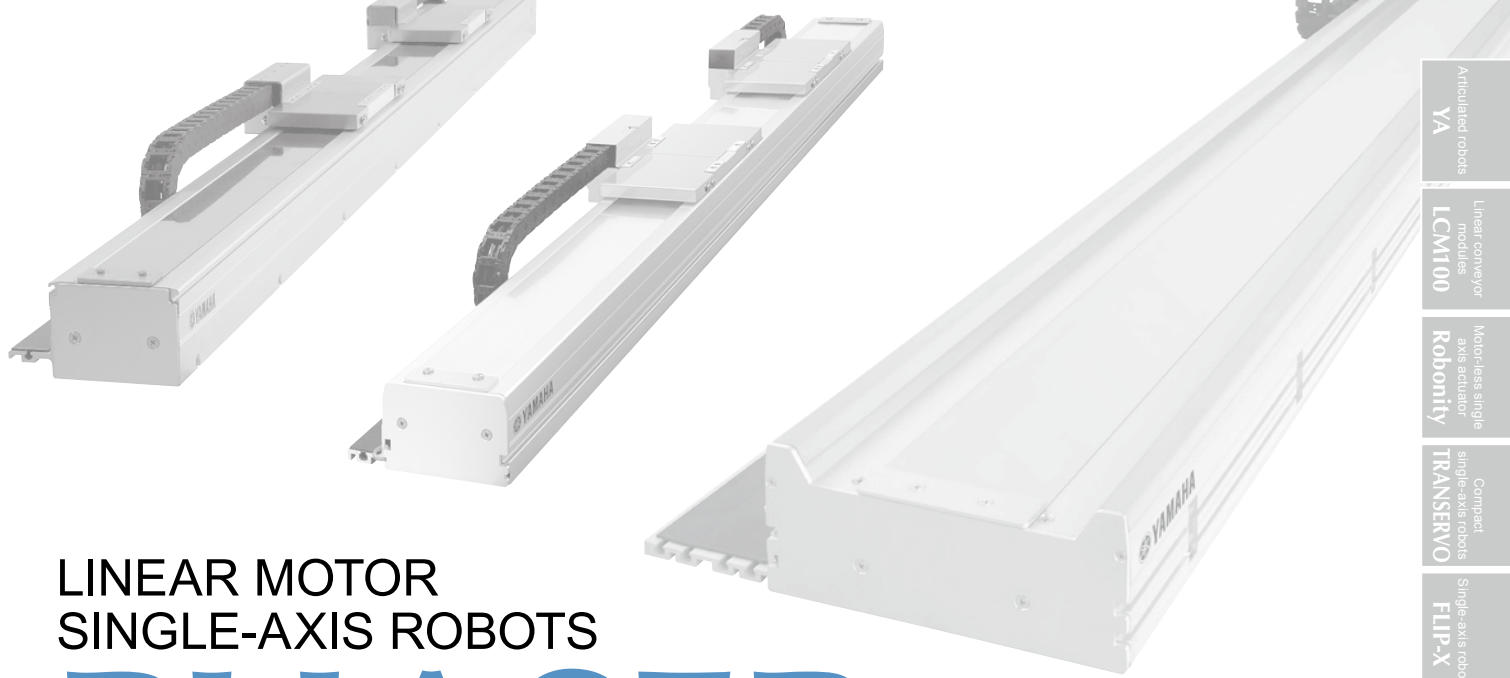

LINEAR MOTOR SINGLE-AXIS ROBOTS

PHASER SERIES

Articulated robots YA	Linear conveyor modules LCM100	Motor-less single axis actuator Robonity	Compact single-axis robots TRANSEVO	Single-axis robots FLIP-X	Linear motor single-axis robots PHASER	Cartesian robots XY-X	SCARA robots YK-X	Pick & place robots YP-X	CLEAN	CONTROLLER INFORMATION
--------------------------	--------------------------------------	--	---	------------------------------	--	-----------------------------	-------------------------	--------------------------------	-------	---------------------------

CONTENTS

■ PHASER SPECIFICATION SHEET	240
■ Robot ordering method description	240
■ Robot ordering method terminology	241
MF TYPE	
MF7/MF7D	242
MF15/MF15D	248
MF20/MF20D	252
MF30/MF30D	255
MF75/MF75D	258

PHASER SPECIFICATION SHEET

Type	Size (mm) ^{Note 1}	Model	Carrier	Maximum payload (kg)	Maximum speed (mm/sec.)	Stroke (mm)	Detailed info page
MF type Flat type with core Linear motor specifications	W85 × H80	MF7	Single	10 (7) ^{Note 2}	2500	100 to 4000 (Horizontal) 100 to 2000 (Wall mount)	P.242
		MF7D	Double			100 to 3800 (Horizontal) 100 to 1800 (Wall mount)	P.242
	W100 × H80	MF15	Single	30 (15) ^{Note 2}		100 to 4000 (Horizontal) 100 to 2000 (Wall mount)	P.248
		MF15D	Double			100 to 3800 (Horizontal) 100 to 1800 (Wall mount)	P.248
	W150 × H80	MF20	Single	40 (20) ^{Note 2}		150 to 4050	P.252
		MF20D	Double			150 to 3850	P.252
		MF30	Single	60 (30) ^{Note 2}		100 to 4000	P.255
		MF30D	Double			150 to 3750	P.255
	W210 × H100	MF75	Single	160 (75) ^{Note 2}		1000 to 4000	P.258
		MF75D	Double			680 to 3680	P.258

Note 1. The size shows approximate maximum cross sectional size.

Note 2. When using at the maximum speed, the maximum payload becomes the value in ().

⚠ Precautions for use

■ Handling

- Please be sure to read "PHASER Series Instruction Manual" carefully to have full understanding of its contents before using this product and strictly observe each instruction.
- Dropping or hitting this product may cause it to break. Always handle it carefully.
- Never disassemble this product. Entry of a foreign object will cause deterioration of accuracy.
- This product uses a magnetic type linear scale. Do not bring anything that generates a strong magnetic field near the robot itself as it may cause damage to the linear scale.

■ Installation place and environment

When installing this product, avoid the place where any of the following conditions applies.

- The ambient temperature is outside of the 0 °C to 40 °C range.
- Dielectric powder such as iron powder, dust, moist, salt or organic solvent is produced and flies in the air.
- Strong electric field, strong magnetic field, etc. occur.
- The product is affected by vibration or impact.
- Dewing occurs, or corrosive gas or combustible gas is generated.
- The product is exposed to direct sun or radiant heat.
- A noise source exists in the surrounding area.
- Inspection and cleaning cannot be performed.

■ Safety precaution

- A high performance rare earth magnets are used in the motor section of this product. For this reason, bringing a magnetic response type device or a medical device such as a heart pace maker close to the robot may cause it to malfunction. Be careful not to bring such a device close to the robot.

Robot ordering method description

In the order format for the YAMAHA linear motor single-axis robots PHASER series, the notation (letters/numbers) for the mechanical section is shown linked to the controller section notation.

[Example]

● Mechanical ▶ MF20

- Cable carrier take out direction ▷ RH
- Grease ▷ Standard
- Optional cable carrier for users ▷ S
- Stroke ▷ 550mm
- Origin position ▷ Change (R side)
- Cable length ▷ 3.5m

● Controller ▶ SR1-P

- Regenerative unit ▷ Required
- I/O selection ▷ NPN

● Ordering method

MF20 - RH - S - Z - 550 - 3L - SR1 - P10 - R - N

Mechanical section

Controller section

This page describes using the ordering form for mechanical components.

To find detailed controller information see the controller page.

SR1-P ▶ [P.540](#), TS-P ▶ [P.514](#), RDV-P ▶ [P.528](#)

Mechanical section

● Single carriage

① Model		② Cable carrier entry location	④ Optional cable carrier for users		⑤ Origin position change	⑥ Grease type		⑦ Stroke	⑧ Cable length	
MF7	MF7A	RH Horizontal, right	No entry	None	No entry	L side	No entry	Standard	3L	3.5m
MF15	MF15A	LH Horizontal, left	S	S type	Z	R side	GC	Clean	5L	5m
MF20	MF20A	RW Wall mounted, right	M	M type					10L	10m
MF30	MF30A	LW Wall mounted, left	L	L type					3K	3.5m
MF75	MF75A								5K	5m
									10K	10m

● Double carriage

① Model		③ Installing direction	④ Optional cable carrier for users		⑥ Grease type		⑦ Stroke	⑧ Cable length	
MF7D	MF7AD	H Horizontal installation	No entry	None	No entry	Standard	3L	3.5m	
MF15D	MF15AD		S	S type	GC	Clean	5L	5m	
MF20D	MF20AD	W Wall mounted installation	M	M type			10L	10m	
MF30D	MF30AD		L	L type			3K	3.5m	
MF75D	MF75AD						5K	5m	
							10K	10m	

Robot ordering method terminology

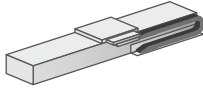
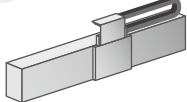
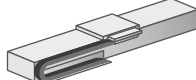
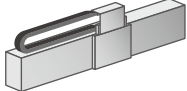
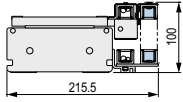
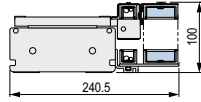
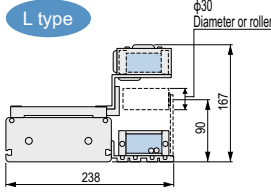
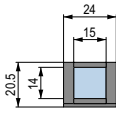
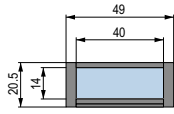
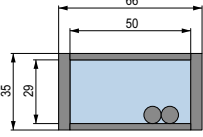
<p>① Model</p>	<p>Enter the robot unit model. Select from 2 types: incremental specifications and semi-absolute specifications.</p>
<p>② Cable carrier entry location</p>	<p>Select what direction to install the robot (horizontal / wall mounted) and what direction to extract the robot cable carrier.</p> <div style="display: flex; justify-content: space-around; align-items: flex-start;"> <div style="text-align: center;"> <p>RH Horizontal, right</p>  </div> <div style="text-align: center;"> <p>RW Wall hanging, right</p>  </div> <div style="text-align: center;"> <p>LH Horizontal, left</p>  </div> <div style="text-align: center;"> <p>LW Wall hanging, left</p>  </div> </div> <p>Note. Be sure to install in the direction as specified (in cable carrier take-out direction drawing and various specification drawings) individually. Installation in any other way will cause a failure. For requirement of installation in any way other than the above standard installation, please consult YAMAHA as special arrangement will be available.</p>
<p>③ Installing direction</p>	<p>Select what direction to install the robot (horizontal / wall mounted).</p>
<p>④ Optional cable carrier for users</p>	<p>Please specify if a cable carrier is needed for customer wiring. [MF type] (For MF20)</p> <div style="display: flex; justify-content: space-around; align-items: flex-start;"> <div style="text-align: center;"> <p>S type</p>  </div> <div style="text-align: center;"> <p>M type</p>  </div> <div style="text-align: center;"> <p>L type</p>  </div> </div> <div style="display: flex; justify-content: space-around; align-items: flex-start; margin-top: 10px;"> <div style="text-align: center;">  </div> <div style="text-align: center;">  </div> <div style="text-align: center;">  </div> </div> <p>Cable and pipe guide S : $\phi 8$ flexible cable x 1, $\phi 4$ air tube x 1 M : $\phi 8$ flexible cable x 2, $\phi 6$ air tube x 2 L : $\phi 8$ flexible cable x 2, $\phi 8$ air tube x 3</p> <p style="text-align: right;"> Space for optional cable for users</p>
<p>⑤ Origin position change</p>	<p>Origin point position can be changed.</p>
<p>⑥ Grease type</p>	<p>Clean grease can be selected.</p>
<p>⑦ Stroke</p>	<p>Select the stroke for the robot operating range.</p>
<p>⑧ Cable length</p>	<p>Select the length of the robot cable connecting the robot to the controller.</p> <p>3L : 3.5m (Standard) 5L : 5m 10L : 10m 3K : 3.5m (Flexible cable) 5K : 5m (Flexible cable) 10K : 10m (Flexible cable)</p>

Articulated robots
YA

Linear conveyor modules
LCM100

Motor-less single axis actuator
Robonity

Compact single-axis robots
TRANSEVO

Single-axis robots
FLIP-X

Linear motor single-axis robots
PHASER

Cartesian robots
XY-X

SCARA robots
YK-X

Pick & place robots
YP-X

CLEAN

CONTROLLER INFORMATION

MF7/MF7D

- Flat type available
- Can be used for wall-mount



Ordering method

Single carriage model

MF7

Model MF7: Incremental MF7A: Semi-absolute ^{Note 1}	Cable carrier entry location RH: Horizontal, right LH: Horizontal, left FRH: Horizontal, right (Flat) FLH: Horizontal, left (Flat) RW: Wall mount, right LW: Wall mount, left	Optional cable carrier for users^{Note 2} No entry: None S: S type M: M type L: L type	Origin position change Horizontal: No entry: L side (Standard) Z: R side (Standard) Wall: No entry: R side (Standard) Z: L side	Grease type No entry: Standard GC: Clean	Stroke^{Note 3} Horizontal: 100 to 4000 (100mm pitch) S: 5m 100 to 2000 (100mm pitch) Wall	Cable length^{Note 4} 3L: 3.5m 5L: 5m 10L: 10m 3K/5K/10K (Flexible cable) ^{Note 5}	TSP Positioner TS-P Driver: Power-supply voltage / Power capacity 110: 100V/200W 210: 200V/200W	LCD monitor No entry: None L: With LCD	I/O selection NP: NPN PN: PNP CC: CC-Link DN: DeviceNet™ EP: EtherNet/IP™ GW: No I/O board ^{Note 7}
---	--	---	--	---	---	--	---	---	---

SR1-P **10**

Controller SR1-P Driver: Power capacity 10: 200W	Usable for CE No entry: Standard E: CE marking	I/O selection N: NPN P: PNP CC: CC-Link DN: DeviceNet™ PB: PROFIBUS
---	---	---

RDV-P **2** **10** **RBR1**

Driver RDV-P Power-supply voltage 2: AC200V	Driver: Power capacity 10: 200W or less	Regenerative unit
--	---	--------------------------

Note 1. For the details of the semi-absolute model, please refer to P.39. RDV-P has an incremental model only.
 Note 2. For models with a 2,100mm or longer stroke, optional L type cable carriers can only be used. Flat type cannot be selected for L type.
 Note 3. Maximum stroke for flat type is 2000mm.
 Note 4. The robot cable is standard cable (3L/5L/10L), but can be changed to flexible cable. See P.614 for details on robot cable.
 Note 5. If a flexible cable is needed for the SR1-P, TS-P, or RDV-P, then select 3K/5K/10K. On the RCX221, the standard cable is a flexible cable, so enter 3L/5L/10L when ordering.
 Note 6. These controllers can be mounted on DIN rails. See P.522 for details.
 Note 7. Select this selection when using the gateway function. For details, see P.66.
 Note. It is possible to provide the model without a cable carrier. To find information on wiring (cable terminals) within the cable carrier see P.622.

Double carriage model

MF7D

Model MF7D: Incremental MF7AD: Semi-absolute ^{Note 1}	Installing direction H: Horizontal installation FH: Horizontal installation (Flat) W: Wall mount installation	Optional cable carrier for users^{Note 2} No entry: None S: S type M: M type L: L type	Grease type No entry: Standard GC: Clean	Stroke^{Note 3} Horizontal: 100 to 3800 (100mm pitch) S: 5m 100 to 1800 (100mm pitch) Wall	Cable length 3L: 3.5m 5L: 5m 10L: 10m 3K/5K/10K (Flexible cable) ^{Note 5}	Controller RCX320 RCX221 SR1-P (2 units) TS-P (2 units) RDV-P (2 units)
---	---	---	---	---	---	---

Note. Specify various controller setting items.

Specifications

Model	MF7	MF7D
Driving method	Steel cored linear motor with falt magnet	
Repeatability (μm)	+/-5	
Scale (μm)	Magnetic type: resolution of 1	
Maximum speed^{Note 2} (mm/sec)	2500	
Rated thrust (N)	37	
Maximum payload (kg)	10 ^{Note 1}	
Stroke (mm)	Horizontal	100 to 4000 (100mm pitch)
	Wall mount	100 to 2000 (100mm pitch)
Linear guide	Horizontal	100 to 3800 (100mm pitch)
	Wall mount	100 to 1800 (100mm pitch)
Maximum cross-section outside dimensions (mm)	W85 × H80 (except the cable carrier section)	
Total length (mm)	Stroke+280	Stroke+480
Cable length (m)	Standard: 3.5 / Option: 5.10	

Note. A vertical model (with brake) is not available with the PHASER series.
 Note. The basic specifications of semi-absolute model are the same as those of the incremental model.
 Note 1. Payload per carrier. When the payload exceeds 7kg, please consult our sales office or sales representative.
 Note 2. Table of maximum speed

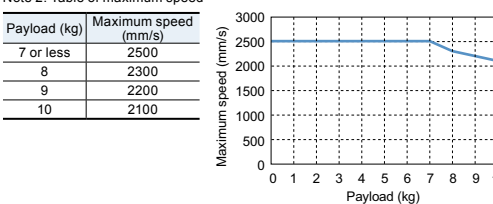

Allowable overhang

	Horizontal installation (Unit: mm)			Wall installation (Unit: mm)		
	A	B	C	A	B	C
1kg	3000	3000	680	700	3000	3000
3kg	3000	1350	215	195	1260	3000
5kg	2900	830	125	90	630	2480
7kg	2400	580	85	50	360	1680
9kg	2200	460	60			
10kg	2100	410	55			

Note. Distance from center of slider top to center of gravity of object being carried at a guide service life of 10,000 km.

Static loading moment

MY	MP	MR
156	156	194

(Unit: N·m)

Controller

Controller	Operating method
SR1-P10	Programming / I/O point trace / Remote command / Operation using RS-232C communication
RCX320 RCX221 RCX340	I/O point trace / Remote command
TS-P110	Pulse train control
TS-P210	
RDV-P210-RBR1	

Cable carrier entry location

Note. Be sure to install in the direction as specified (in cable carrier take-out direction drawing and various specification drawings) individually. Installation in any other way will cause a failure. For requirement of installation in any way other than the above standard installation, please consult YAMAHA as special arrangement will be available.

Optional cable carrier for users

Cable and air tube guide
 S: φ8 flexible cable x 1, φ4 air tube x 1
 M: φ8 flexible cable x 2, φ8 air tube x 2
 L: φ8 flexible cable x 2, φ8 air tube x 3

□ Space for optional cable for users

MF7 single carriage horizontal mount model **RH**

Optional cable carrier M type **Optional cable carrier S type**

Detail of section D **Cross-section of E-E**

Cross-section of cable carrier

Effective stroke	100	200	300	400	500	600	700	800	900	1000	1100	1200	1300	1400	1500	1600	1700	1800	1900	2000
L	380	480	580	680	780	880	980	1080	1180	1280	1380	1480	1580	1680	1780	1880	1980	2080	2180	2280
A	3	4	5	6	7	8	9	10	11	12	13	14	15	16	17	18	19	20	21	22
B	8	10	12	14	16	18	20	22	24	26	28	30	32	34	36	38	40	42	44	46
C	200	300	400	500	600	700	800	900	1000	1100	1200	1300	1400	1500	1600	1700	1800	1900	2000	2100
Weight (kg)	5.8	6.5	7.3	8	8.7	9.4	10.1	10.9	11.6	12.3	13	13.7	14.5	15.2	15.9	16.6	17.3	18.1	18.8	19.5

MF7 single carriage wall mount model **RW**

Cross-section of optional cable carrier **Cross-section of F-F**

Detail of section G

Standard and S types

Standard and M types

Standard and S types

Effective stroke	100	200	300	400	500	600	700	800	900	1000	1100	1200	1300	1400	1500	1600	1700	1800	1900	2000
L	380	480	580	680	780	880	980	1080	1180	1280	1380	1480	1580	1680	1780	1880	1980	2080	2180	2280
A	3	4	5	6	7	8	9	10	11	12	13	14	15	16	17	18	19	20	21	22
B	8	10	12	14	16	18	20	22	24	26	28	30	32	34	36	38	40	42	44	46
C	200	300	400	500	600	700	800	900	1000	1100	1200	1300	1400	1500	1600	1700	1800	1900	2000	2100
D	220	270	320	370	420	470	520	570	620	670	720	770	820	870	920	970	1020	1070	1120	1170
Weight (kg)	5.8	6.5	7.3	8	8.7	9.4	10.1	10.9	11.6	12.3	13	13.7	14.5	15.2	15.9	16.6	17.3	18.1	18.8	19.5

Articulated robots
YA
Linear conveyer/modelling
LCM100
Motor-less single axis actuator
Robonity
Compact single-axis robots
TRANSEVO
Single-axis robots
FLIP-X
Linear motor single-axis robots
PHASER
Cartesian robots
XY-X
SCARA robots
YK-X
Pick & place robots
YP-X
CLEAN
CONTROLLER INFORMATION

MF7 single carriage horizontal mount model **RH-L** Optional L-type cable carrier

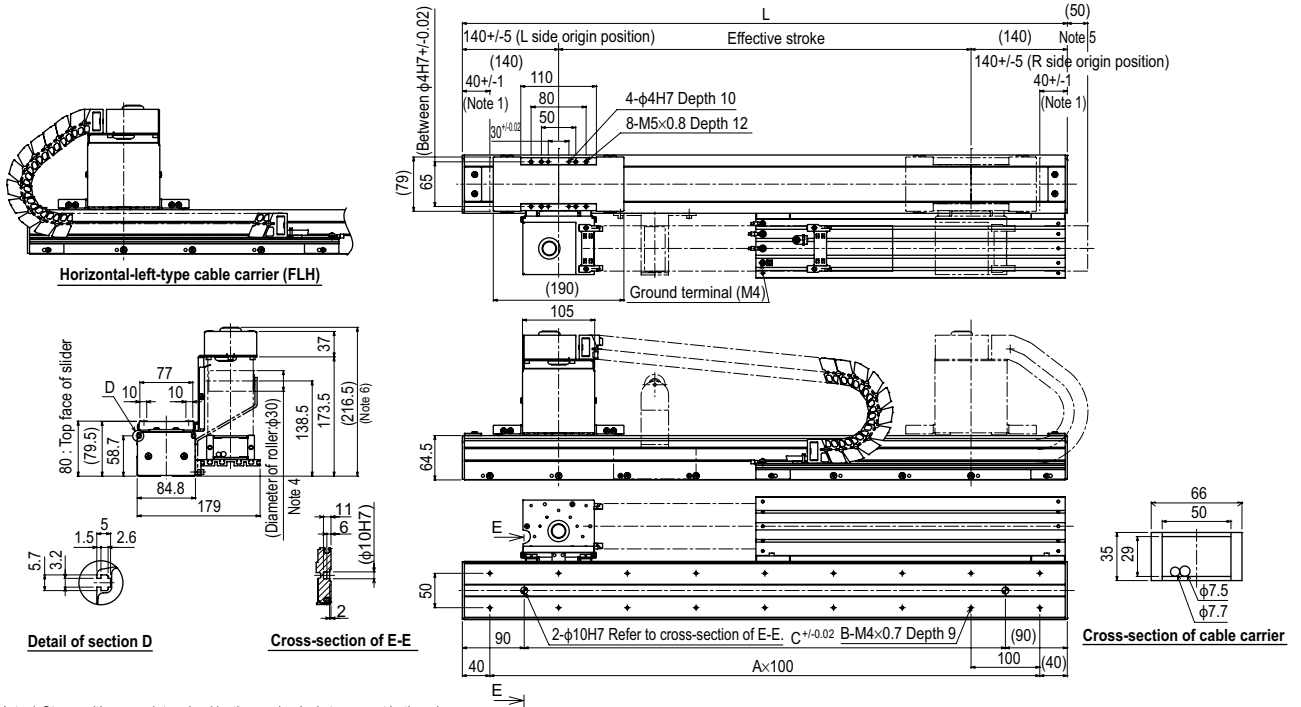

Note 1. Stop positions are determined by the mechanical stoppers at both ends.
 Note 2. The origin is set on the L side at the time of shipment. It can be changed to the R side by parameter setting.
 Note 3. The drawings on this page show the unit with horizontal-right-type cable carrier (RH).
 Note 4. For models with a 3,000mm or longer stroke, a roller is installed to prevent the cable carrier from sagging.
 Note 5. Protrusion is the distance the cable carrier extends from the edge of the unit.
 Note 6. Depending on the stroke and the operating conditions, the cable carrier bending radius might be larger, making it higher than the dimensions shown in the diagram.

Effective stroke	100	200	300	400	500	600	700	800	900	1000	1100	1200	1300	1400	1500	1600	1700	1800	1900	2000	2100	2200	2300	2400	2500	2600	2700	2800	2900	3000	3100	3200	3300	3400	3500	3600	3700	3800	3900	4000
L	380	480	580	680	780	880	980	1080	1180	1280	1380	1480	1580	1680	1780	1880	1980	2080	2180	2280	2380	2480	2580	2680	2780	2880	2980	3080	3180	3280	3380	3480	3580	3680	3780	3880	3980	4080	4180	4280
A	3	4	5	6	7	8	9	10	11	12	13	14	15	16	17	18	19	20	21	22	23	24	25	26	27	28	29	30	31	32	33	34	35	36	37	38	39	40	41	42
B	8	10	12	14	16	18	20	22	24	26	28	30	32	34	36	38	40	42	44	46	48	50	52	54	56	58	60	62	64	66	68	70	72	74	76	78	80	82	84	86
C	200	300	400	500	600	700	800	900	1000	1100	1200	1300	1400	1500	1600	1700	1800	1900	2000	2100	2200	2300	2400	2500	2600	2700	2800	2900	3000	3100	3200	3300	3400	3500	3600	3700	3800	3900	4000	4100
Weight (kg)	5.8	6.5	7.3	8.0	8.7	9.4	10.1	10.9	11.6	12.3	13.0	13.7	14.5	15.2	15.9	16.6	17.3	18.1	18.8	19.5	20.2	20.9	21.7	22.4	23.1	23.8	24.5	25.3	26.0	26.7	27.4	28.1	28.9	29.6	30.3	31.0	31.7	32.5	33.2	33.9

MF7 single carriage horizontal mount model **FRH** Flat type

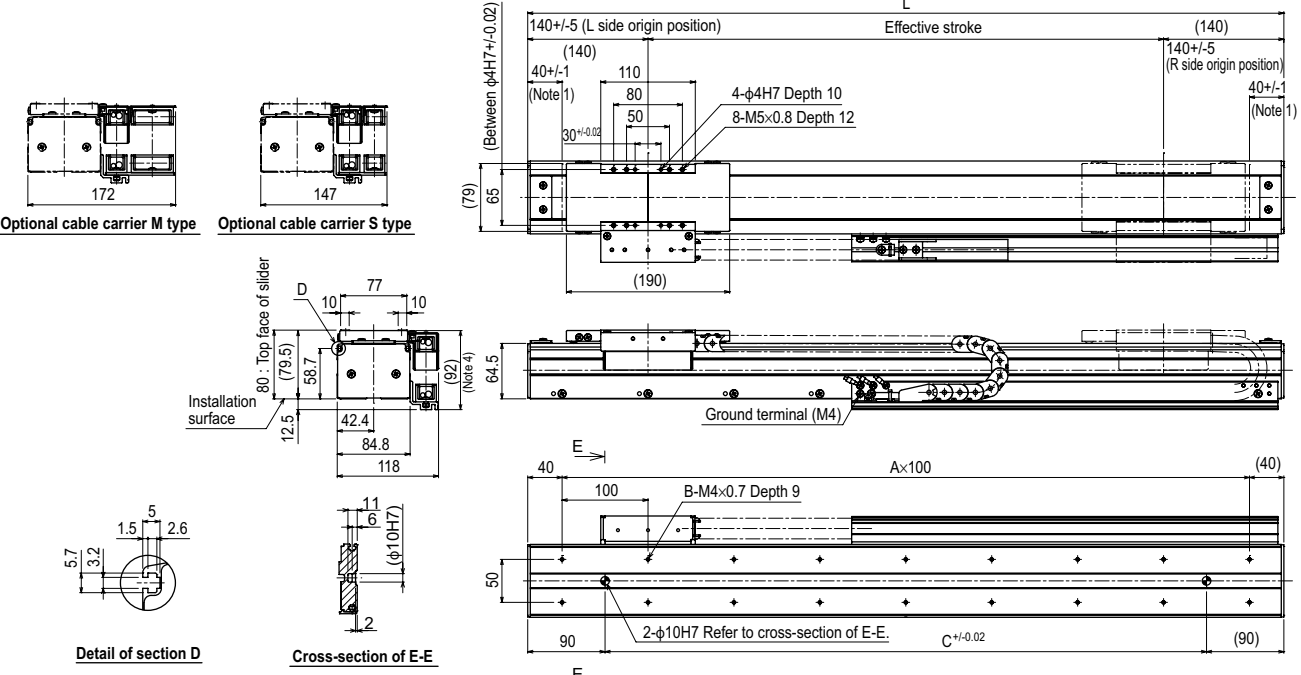

Note 1. Stop positions are determined by the mechanical stoppers at both ends.
 Note 2. The origin is set on the L side at the time of shipment. It can be changed to the R side by parameter setting.
 Note 3. The drawings on this page show the unit with horizontal-right-type cable carrier (RH).
 Note 4. Depending on the stroke and the operating conditions, the cable carrier bending radius might be larger, making it higher than the dimensions shown in the diagram.

Effective stroke	100	200	300	400	500	600	700	800	900	1000	1100	1200	1300	1400	1500	1600	1700	1800	1900	2000
L	380	480	580	680	780	880	980	1080	1180	1280	1380	1480	1580	1680	1780	1880	1980	2080	2180	2280
A	3	4	5	6	7	8	9	10	11	12	13	14	15	16	17	18	19	20	21	22
B	8	10	12	14	16	18	20	22	24	26	28	30	32	34	36	38	40	42	44	46
C	200	300	400	500	600	700	800	900	1000	1100	1200	1300	1400	1500	1600	1700	1800	1900	2000	2100
Weight (kg)	5.8	6.5	7.3	8	8.7	9.4	10.1	10.9	11.6	12.3	13	13.7	14.5	15.2	15.9	16.6	17.3	18.1	18.8	19.5

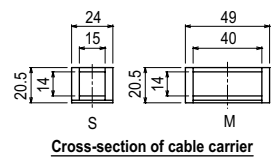

MF7D double carriage horizontal mount model **H**

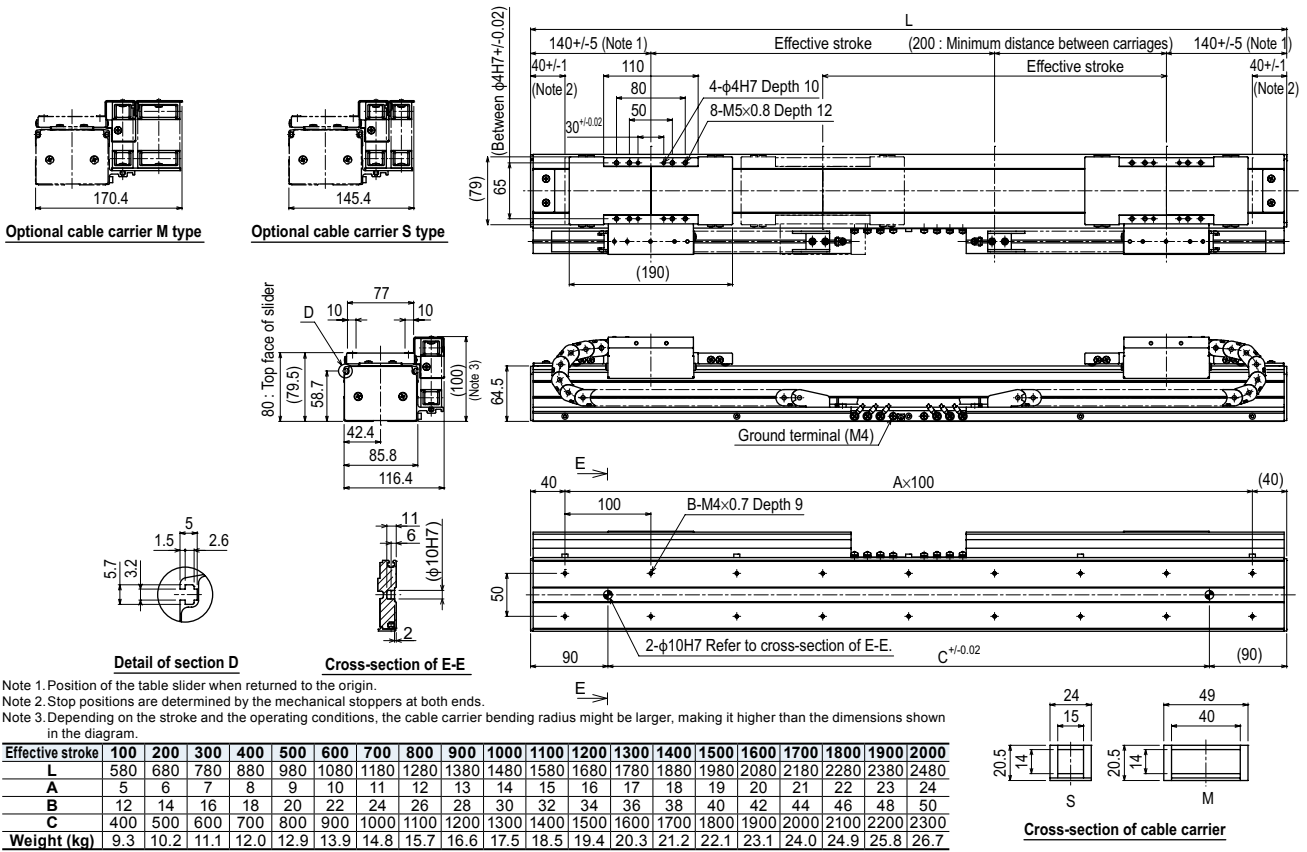

MF7D double carriage wall mount model **W**

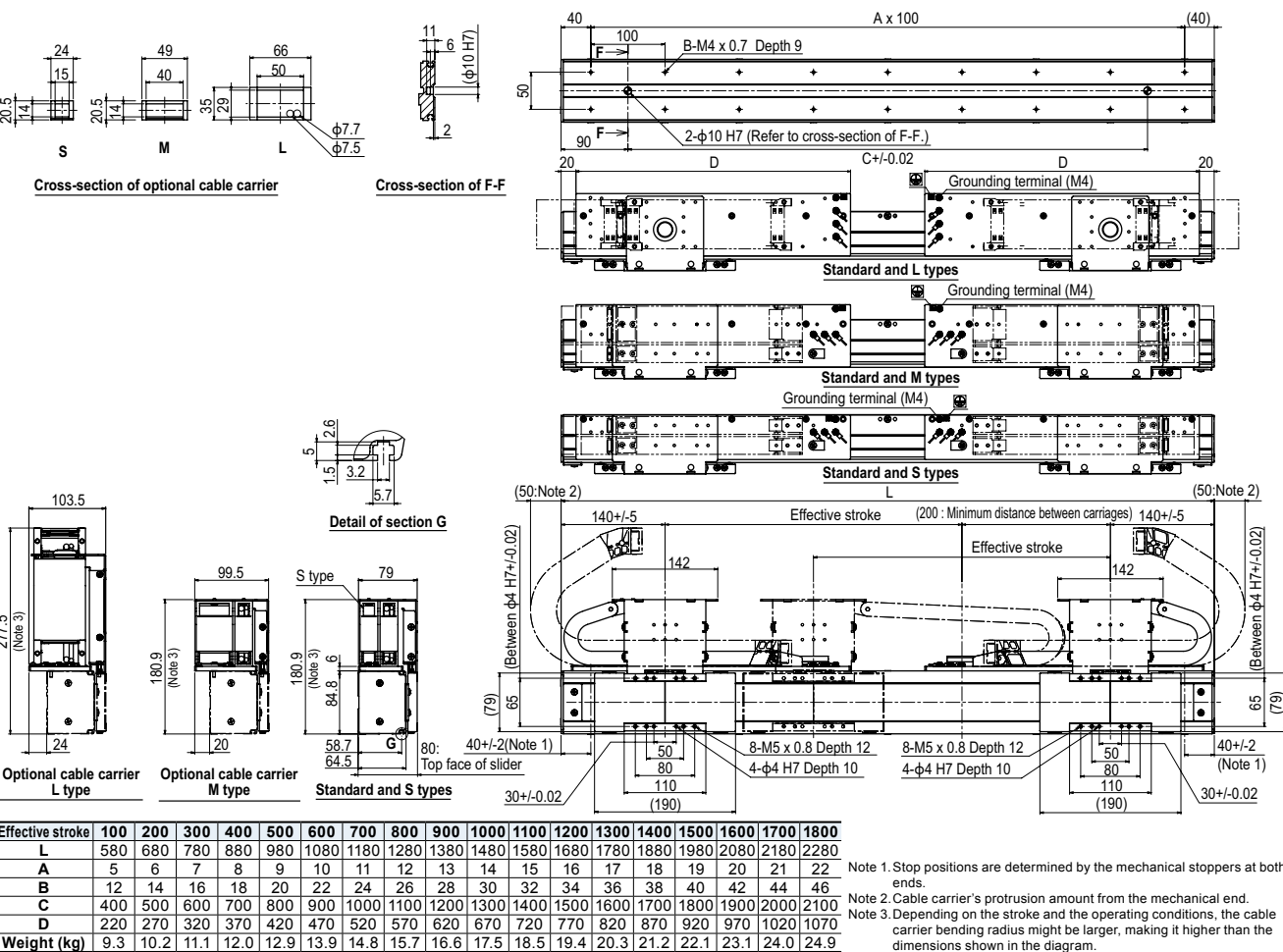

MF7D double carriage horizontal mount model **H-L** Optional L-type cable carrier

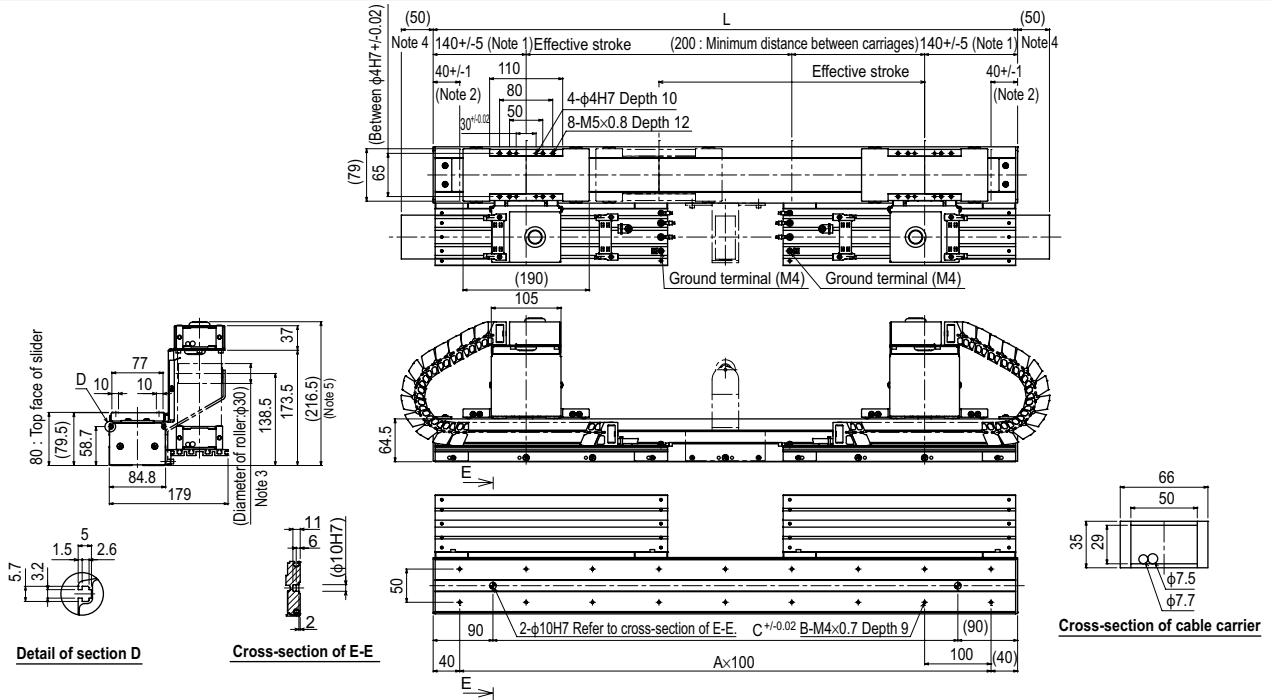

Note 1. Position of the table slider when returned to the origin.
 Note 2. Stop positions are determined by the mechanical stoppers at both ends.
 Note 3. For models with a 3,000mm or longer stroke, a roller is installed to prevent the cable carrier from sagging.
 Note 4. Protrusion is the distance the cable carrier extends from the edge of the unit.
 Note 5. Depending on the stroke and the operating conditions, the cable carrier bending radius might be larger, making it higher than the dimensions shown in the diagram.

Effective stroke	100	200	300	400	500	600	700	800	900	1000	1100	1200	1300	1400	1500	1600	1700	1800	1900	2000	2100	2200	2300	2400	2500	2600	2700	2800	2900	3000	3100	3200	3300	3400	3500	3600	3700	3800
L	580	680	780	880	980	1080	1180	1280	1380	1480	1580	1680	1780	1880	1980	2080	2180	2280	2380	2480	2580	2680	2780	2880	2980	3080	3180	3280	3380	3480	3580	3680	3780	3880	3980	4080	4180	4280
A	5	6	7	8	9	10	11	12	13	14	15	16	17	18	19	20	21	22	23	24	25	26	27	28	29	30	31	32	33	34	35	36	37	38	39	40	41	42
B	12	14	16	18	20	22	24	26	28	30	32	34	36	38	40	42	44	46	48	50	52	54	56	58	60	62	64	66	68	70	72	74	76	78	80	82	84	86
C	400	500	600	700	800	900	1000	1100	1200	1300	1400	1500	1600	1700	1800	1900	2000	2100	2200	2300	2400	2500	2600	2700	2800	2900	3000	3100	3200	3300	3400	3500	3600	3700	3800	3900	4000	4100
Weight (kg)	9.3	10.2	11.1	12.0	12.9	13.9	14.8	15.7	16.6	17.5	18.5	19.4	20.3	21.2	22.1	23.1	24.0	24.9	25.8	26.7	27.7	28.6	29.5	30.4	31.3	32.3	33.2	34.1	35.0	35.9	36.9	37.8	38.7	39.6	40.5	41.5	42.4	43.3

MF7D double carriage horizontal mount model **FH** Flat type

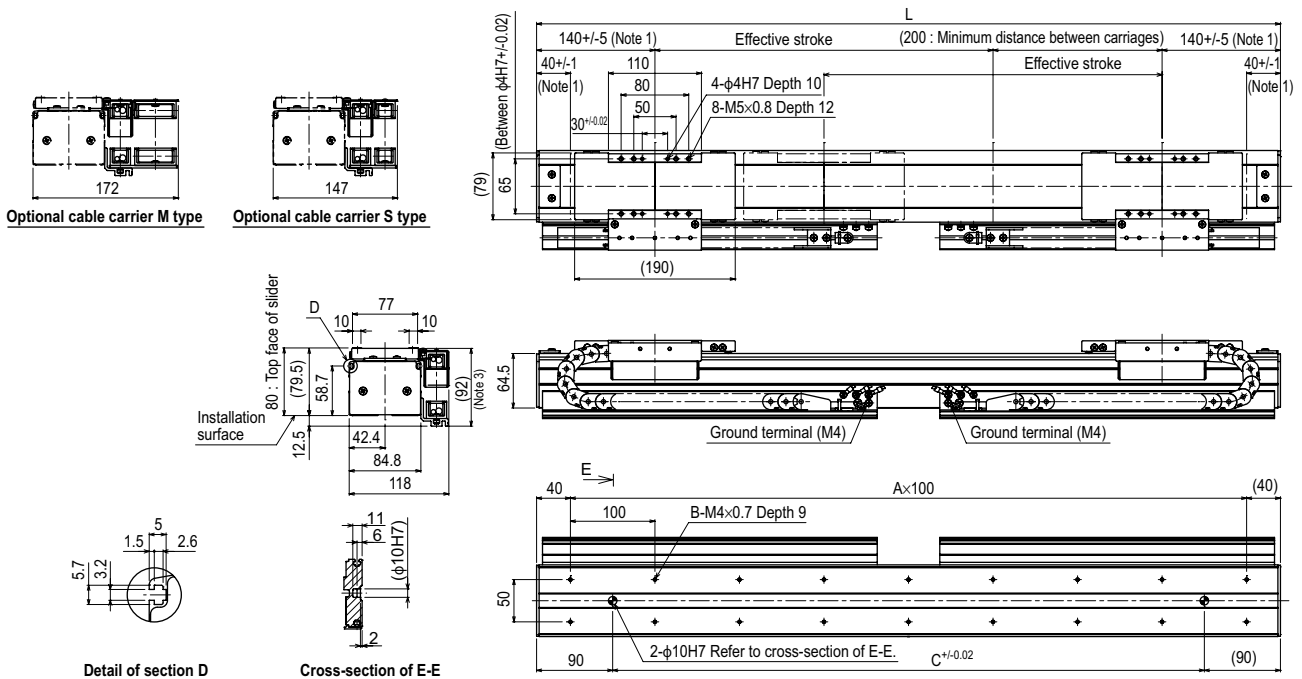

Note 1. Position of the table slider when returned to the origin.
 Note 2. Stop positions are determined by the mechanical stoppers at both ends.
 Note 3. Depending on the stroke and the operating conditions, the cable carrier bending radius might be larger, making it higher than the dimensions shown in the diagram.

Effective stroke	100	200	300	400	500	600	700	800	900	1000	1100	1200	1300	1400	1500	1600	1700	1800	1900	2000
L	580	680	780	880	980	1080	1180	1280	1380	1480	1580	1680	1780	1880	1980	2080	2180	2280	2380	2480
A	5	6	7	8	9	10	11	12	13	14	15	16	17	18	19	20	21	22	23	24
B	12	14	16	18	20	22	24	26	28	30	32	34	36	38	40	42	44	46	48	50
C	400	500	600	700	800	900	1000	1100	1200	1300	1400	1500	1600	1700	1800	1900	2000	2100	2200	2300
Weight (kg)	9.3	10.2	11.1	12.0	12.9	13.9	14.8	15.7	16.6	17.5	18.5	19.4	20.3	21.2	22.1	23.1	24.0	24.9	25.8	26.7

Articulated robots
YA

Linear conveyor
modules
LCM100

Motor-less single
axis actuator
Robonity

Compact
single-axis robots
TRANSERVO

Single-axis robots
FLIP-X

Linear motor
single-axis robots
PHASER

Cartesian
robots
XY-X

SCARA
robots
YK-X

Pick & place
robots
YP-X

CLEAN

CONTROLLER

INFORMATION

MF15/MF15D

Can be used for wall-mount

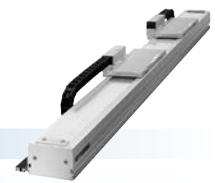

Ordering method

Single carriage model

MF15		TSP		SR1-P		RDV-P				
Model MF15: Incremental MF15A: Semi-absolute ^{Note 1}	Cable carrier entry location RH: Horizontal, right LH: Horizontal, left RW: Wall mount, right LW: Wall mount, left	Optional cable carrier for users^{Note 2} No entry: None S: S type M: M type L: L type	Origin position change Horizontal: No entry: L side (Standard) Z: R side Wall: No entry: R side (Standard) Z: L side	Grease type No entry: Standard GC: Clean	Stroke Horizontal: 100 to 4000 (100mm pitch) 100 to 2000 (100mm pitch) Wall: 100 to 2000 (100mm pitch)	Cable length^{Note 3} 3L: 3.5m 5L: 5m 10L: 10m 3K/5K/10K (Flexible cable) ^{Note 4}	Positioner^{Note 5} TS-P	Driver: Power-supply voltage / Power capacity 110: 100V/200W 210: 200V/200W	LCD monitor No entry: None L: With LCD	I/O selection NP: NPN PN: PNP CC: CC-Link DN: DeviceNet™ EP: EtherNet/IP™ GW: No I/O board ^{Note 5}
				Controller		RDV-P		RBR1		
				10. 200W		2. AC200V		10. 200W or less		
				Usable for CE No entry: Standard E: CE marking		Power-supply voltage		Regenerative unit		

Note 1. For the details of the semi-absolute model, please refer to P.39. RDV-P has an incremental model only.
 Note 2. For models with a 2,100mm or longer stroke, optional L type cable carriers can only be used.
 Note 3. The robot cable is standard cable (3L/5L/10L), but can be changed to flexible cable. See P.614 for details on robot cable.
 Note 4. If a flexible cable is needed for the SR1-P, TS-P, or RDV-P, then select 3K/5K/10K. On the RCX221, the standard cable is a flexible cable, so enter 3L/5L/10L when ordering.
 Note 5. These controllers can be mounted on DIN rails. See P.522 for details.
 Note 6. Select this selection when using the gateway function. For details, see P.66.
 Note. It is possible to provide the model without a cable carrier. To find information on wiring (cable terminals) within the cable carrier see P.622.

Double carriage model

MF15D		Controller	
Model MF15D: Incremental MF15AD: Semi-absolute ^{Note 1}	Installing direction H: Horizontal installation W: Wall mount installation	Optional cable carrier for users^{Note 2} No entry: None S: S type M: M type L: L type	Stroke Horizontal: 100 to 3800 (100mm pitch) 100 to 1800 (100mm pitch) Wall: 100 to 1800 (100mm pitch)
		Grease type No entry: Standard GC: Clean	Cable length 3L: 3.5m 5L: 5m 10L: 10m 3K/5K/10K (Flexible cable) ^{Note 4}
			Controller RCX320 RCX221 SR1-P (2 units) TS-P (2 units) RDV-P (2 units)

Note. Specify various controller setting items.

Specifications

Model	MF15	MF15D
Driving method	Steel cored linear motor with falt magnet	
Repeatability (µm)	+/-5	
Scale (µm)	Magnetic type: resolution of 1	
Maximum speed^{Note 2} (mm/sec)	2500	
Rated thrust (N)	54	
Maximum payload^{Note 1} (kg)	30	
Stroke (mm)	Horizontal	100 to 4000 (100mm pitch) / 100 to 3800 (100mm pitch)
	Wall mount	100 to 2000 (100mm pitch) / 100 to 1800 (100mm pitch)
Linear guide	4 rows of circular arc grooves x 2 rail	
Maximum cross-section outside dimensions (mm)	W100 x H80 (except the cable carrier section)	
Total length (mm)	Stroke+260	Stroke+460
Cable length (m)	Standard: 3.5 / Option: 5,10	

Note. A vertical model (with brake) is not available with the PHASER series.
 Note. The basic specifications of semi-absolute model are the same as those of the incremental model.

Note 1. Payload per carrier. When the payload exceeds 15kg, please consult our sales office or sales representative.

Note 2. Table of maximum speed

Payload (kg)	Maximum speed (mm/s)
15 or less	2500
20	2200
25	1800
30	1500

Allowable overhang

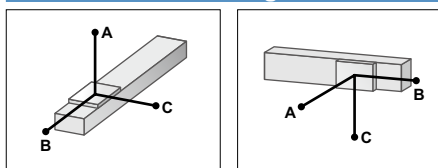

Horizontal installation (Unit: mm)

	A	B	C
5kg	3000	3000	915
10kg	2604	1542	481
15kg	2368	1051	340
20kg	1820	600	260
25kg	1470	450	175
30kg	1250	310	145

Wall installation (Unit: mm)

	A	B	C
5kg	865	1880	3060
10kg	410	905	2115
15kg	255	575	1910
20kg	170	410	1780
25kg	120	295	1660
30kg	90	215	1440

Note. Distance from center of slider top to center of gravity of object being carried at a guide service life of 10,000 km.

Static loading moment

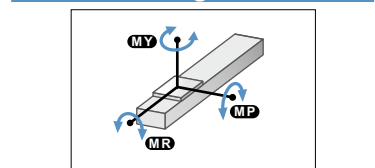

MY	MP	MR
290	291	256

Controller

Controller	Operating method
SR1-P10	Programming / I/O point trace / Remote command / Operation using RS-232C communication
RCX320 RCX221 RCX340	I/O point trace / Remote command
TS-P110 TS-P210	Pulse train control
RDV-P210-RBR1	

Cable carrier entry location

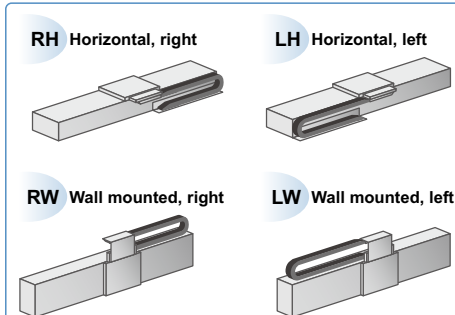

Note. Be sure to install in the direction as specified (in cable carrier take-out direction drawing and various specification drawings) individually. Installation in any other way will cause a failure. For requirement of installation in any way other than the above standard installation, please consult YAMAHA as special arrangement will be available.

Optional cable carrier for users

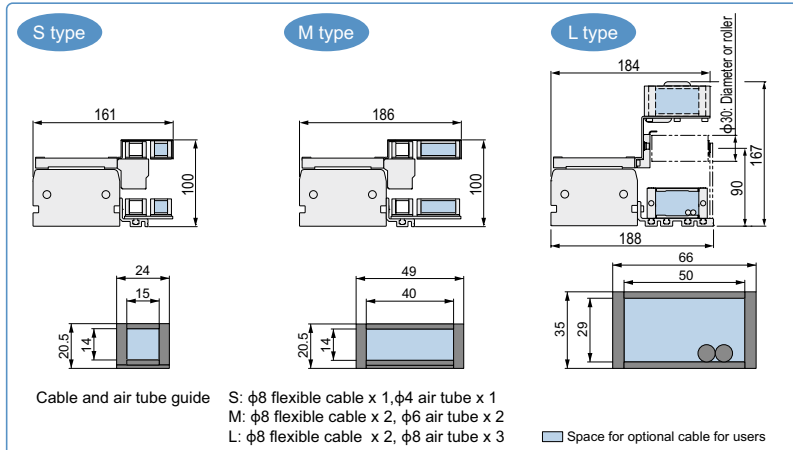

Cable and air tube guide

S: φ8 flexible cable x 1, φ4 air tube x 1
 M: φ8 flexible cable x 2, φ6 air tube x 2
 L: φ8 flexible cable x 2, φ8 air tube x 3

Space for optional cable for users

MF15 single carriage horizontal mount model **RH**

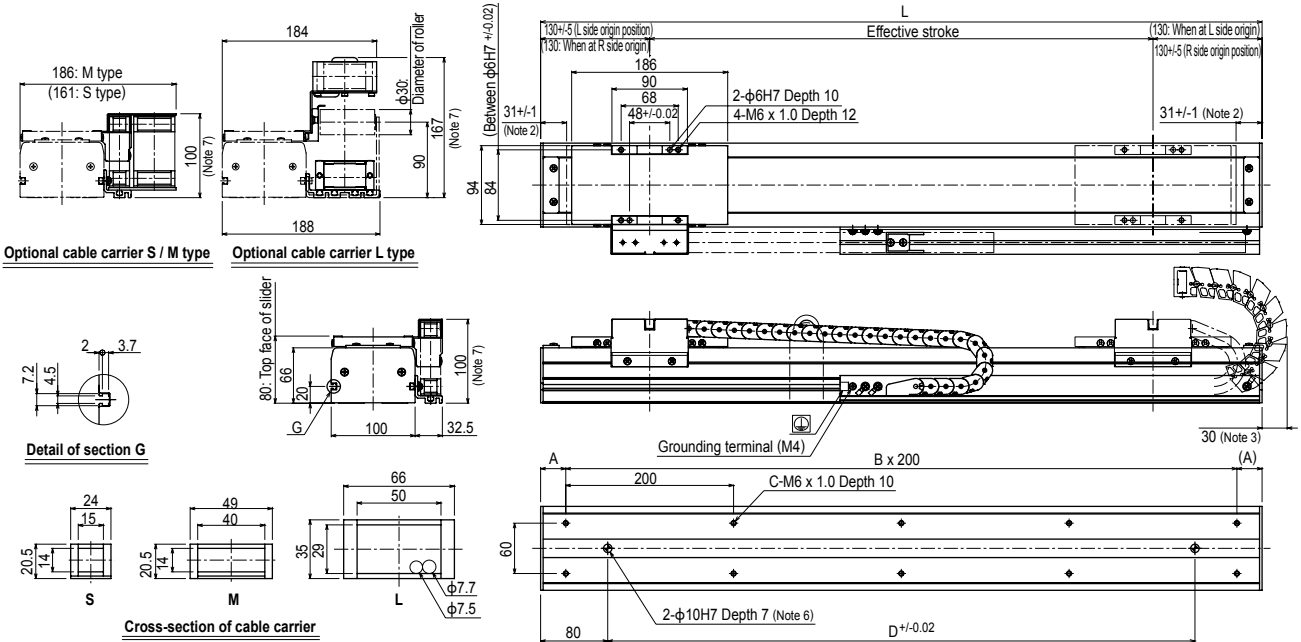

Note 1. Position of the table slider when returned to the origin.
 Note 2. Stop positions are determined by the mechanical stoppers at both ends.
 Note 3. Protrusion is the distance the cable carrier extends from the edge of unit when an optional L type cable carrier is used.
 Note 4. For models with a 2,100mm or longer stroke, optional L type cable carriers can only be used.
 Note 5. For models with a 3,000mm or longer stroke and an optional L type cable carrier, a roller is installed to prevent the cable carrier from sagging.
 Note 6. When using φ10 H7 hole, do not insert the pin more than the depth stated in the drawing. Otherwise, the motor may break.
 Note 7. Depending on the stroke and the operating conditions, the cable carrier bending radius might be larger, making it higher than the dimensions shown in the diagram.

Effective stroke	100	200	300	400	500	600	700	800	900	1000	1100	1200	1300	1400	1500	1600	1700	1800	1900	2000	2100	2200	2300	2400	2500	2600	2700	2800	2900	3000	3100	3200	3300	3400	3500	3600	3700	3800	3900	4000		
L	360	460	560	660	760	860	960	1060	1160	1260	1360	1460	1560	1660	1760	1860	1960	2060	2160	2260	2360	2460	2560	2660	2760	2860	2960	3060	3160	3260	3360	3460	3560	3660	3760	3860	3960	4060	4160	4260		
A	80	30	80	30	80	30	80	30	80	30	80	30	80	30	80	30	80	30	80	30	80	30	80	30	80	30	80	30	80	30	80	30	80	30	80	30	80	30	80	30	80	30
B	1	2	2	3	3	4	4	5	5	6	6	7	7	8	8	9	9	10	10	11	11	12	12	13	13	14	14	15	15	16	16	17	17	18	18	19	19	20	20	21	21	
C	4	6	6	8	8	10	10	12	12	14	14	16	16	18	18	20	20	22	22	24	24	26	26	28	28	30	30	32	32	34	34	36	36	38	38	40	40	42	42	44	44	
D	200	300	400	500	600	700	800	900	1000	1100	1200	1300	1400	1500	1600	1700	1800	1900	2000	2100	2200	2300	2400	2500	2600	2700	2800	2900	3000	3100	3200	3300	3400	3500	3600	3700	3800	3900	4000	4100		
Weight (kg)	6.3	7.3	8.3	9.3	10.3	11.3	12.3	13.3	14.3	15.4	16.4	17.4	18.4	19.4	20.4	21.4	22.4	23.4	24.4	25.4	26.4	27.4	28.4	29.4	30.4	31.4	32.4	33.4	34.4	35.4	36.4	37.4	38.4	39.4	40.4	41.4	42.4	43.4	44.4	45.4	46.4	

MF15D double carriage horizontal mount model **H**

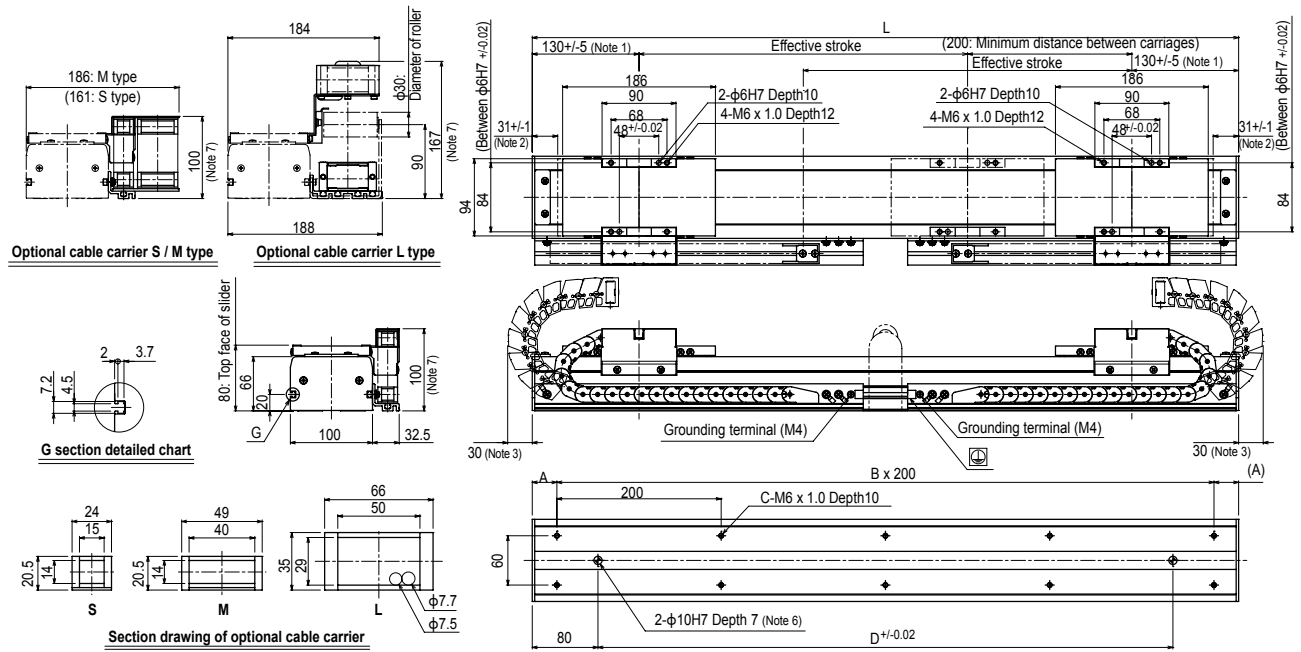

Note 4. For models with a 2,100mm or longer stroke, optional L type cable carriers can only be used.
 Note 5. For models with a 3,000mm or longer stroke and an optional L type cable carrier, a roller is installed to prevent the cable carrier from sagging.
 Note 6. When using φ10 H7 hole, do not insert the pin more than the depth stated in the drawing. Otherwise, the motor may break.
 Note 7. Depending on the stroke and the operating conditions, the cable carrier bending radius might be larger, making it higher than the dimensions shown in the diagram.

Effective stroke	100	200	300	400	500	600	700	800	900	1000	1100	1200	1300	1400	1500	1600	1700	1800	1900	2000	2100	2200	2300	2400	2500	2600	2700	2800	2900	3000	3100	3200	3300	3400	3500	3600	3700	3800	3900	4000	4100	
L	560	660	760	860	960	1060	1160	1260	1360	1460	1560	1660	1760	1860	1960	2060	2160	2260	2360	2460	2560	2660	2760	2860	2960	3060	3160	3260	3360	3460	3560	3660	3760	3860	3960	4060	4160	4260				
A	80	30	80	30	80	30	80	30	80	30	80	30	80	30	80	30	80	30	80	30	80	30	80	30	80	30	80	30	80	30	80	30	80	30	80	30	80	30	80	30	80	30
B	2	3	3	4	4	5	5	6	6	7	7	8	8	9	9	10	10	11	11	12	12	13	13	14	14	15	15	16	16	17	17	18	18	19	19	20	20	21	21			
C	6	8	8	10	10	12	12	14	14	16	16	18	18	20	20	22	22	24	24	26	26	28	28	30	30	32	32	34	34	36	36	38	38	40	40	42	42	44	44			
D	400	500	600	700	800	900	1000	1100	1200	1300	1400	1500	1600	1700	1800	1900	2000	2100	2200	2300	2400	2500	2600	2700	2800	2900	3000	3100	3200	3300	3400	3500	3600	3700	3800	3900	4000	4100				
Weight (kg)	10.3	11.5	12.6	13.7	14.8	16.0	17.1	18.2	19.3	20.5	21.6	22.7	23.8	25.0	26.1	27.2	28.3	29.5	30.6	31.7	32.8	34.0	35.1	36.2	37.4	38.5	39.6	40.8	41.9	43.1	44.2	45.3	46.4	47.5	48.6	49.7	50.8	51.9	53.0	54.1	55.2	56.3

Articulated robots
YA
 Linear conveyor modules
LCM100
 Motor-less single axis actuator
Robonity
 Compact single-axis robots
TRANSEVO
 Single-axis robots
FLIP-X
 Linear motor single-axis robots
PHASER
 Cartesian robots
XX-X
 SCARA robots
YK-X
 Pick & place robots
YP-X
 CLEAN
 CONTROLLER INFORMATION

MF15 single carriage wall mount model RW

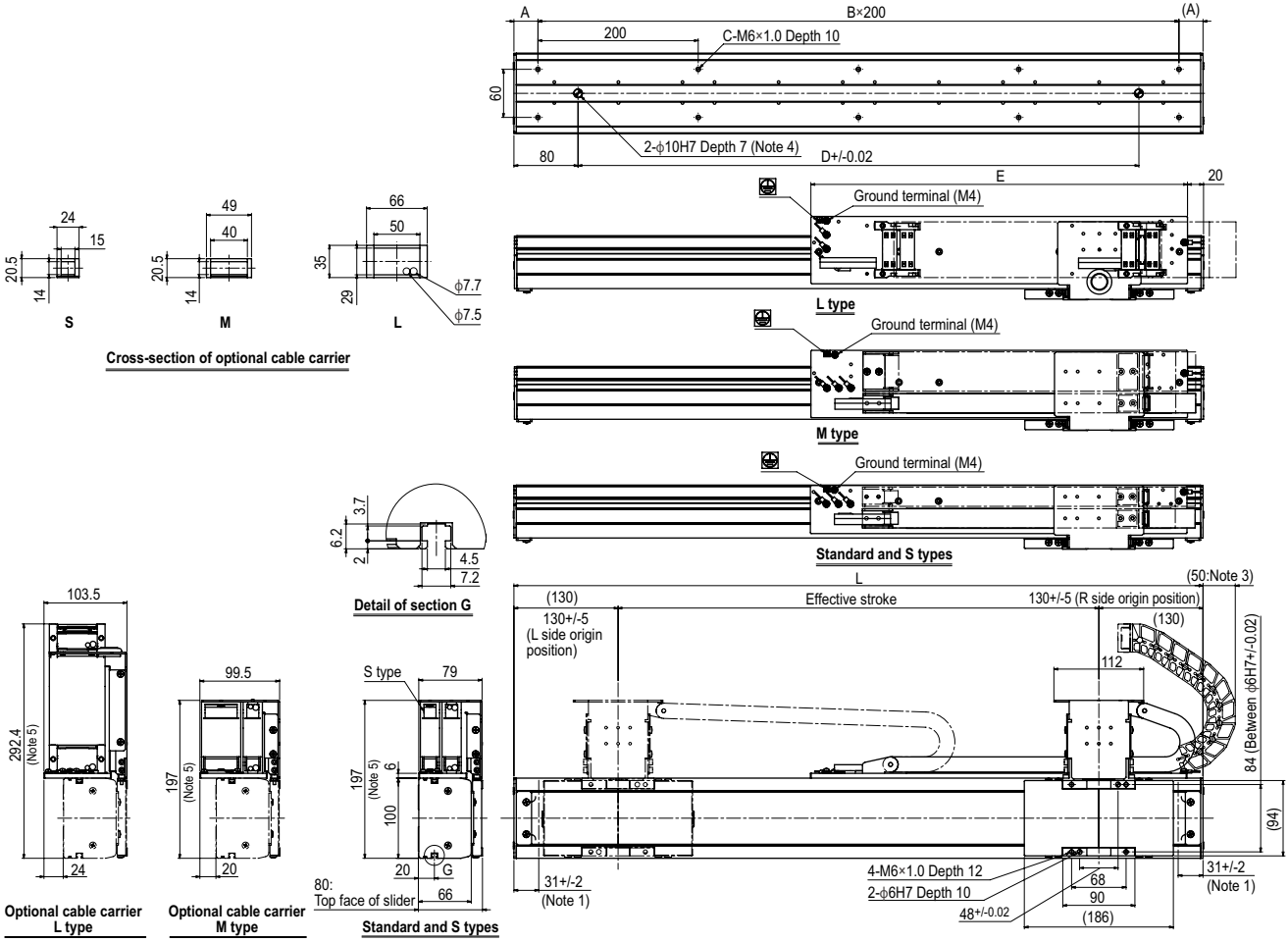

Note 1. Stop positions are determined by the mechanical stoppers at both ends.
 Note 2. The origin is set on the R side at the time of shipment. It can be changed to the L side by parameter setting.
 Note 3. Protrusion is the distance the cable carrier extends from the edge of unit when an optional L type cable carrier is used.
 Note 4. When using φ10 H7 hole, do not insert the pin more than the depth stated in the drawing. Otherwise, the motor may break.
 Note 5. Depending on the stroke and the operating conditions, the cable carrier bending radius might be larger, making it higher than the dimensions shown in the diagram.

Effective stroke	100	200	300	400	500	600	700	800	900	1000	1100	1200	1300	1400	1500	1600	1700	1800	1900	2000
L	360	460	560	660	760	860	960	1060	1160	1260	1360	1460	1560	1660	1760	1860	1960	2060	2160	2260
A	80	30	80	30	80	30	80	30	80	30	80	30	80	30	80	30	80	30	80	30
B	1	2	2	3	3	4	4	5	5	6	6	7	7	8	8	9	9	10	10	11
C	4	6	6	8	8	10	10	12	12	14	14	16	16	18	18	20	20	22	22	24
D	200	300	400	500	600	700	800	900	1000	1100	1200	1300	1400	1500	1600	1700	1800	1900	2000	2100
E	220	270	320	370	420	470	520	570	620	670	720	770	820	870	920	970	1020	1070	1120	1170
Weight (kg)	6.3	7.3	8.3	9.3	10.3	11.3	12.3	13.3	14.3	15.4	16.4	17.4	18.4	19.4	20.4	21.4	22.4	23.4	24.4	25.4

MF20/MF20D

Can be used for wall-mount



Ordering method

Single carriage model

MF20

Model	Cable carrier entry location	Optional cable carrier for users ^{Note 2}	Origin position change	Grease type	Stroke	Cable length
MF20: Incremental MF20AD: Semi-absolute ^{Note 1}	RH: Horizontal, right LH: Horizontal, left RW: Wall mount, right LW: Wall mount, left	No entry: None S: S type M: M type L: L type	Horizontal No entry: L side (Standard) Z: R side Wall No entry: R side (Standard) Z: L side	No entry: Standard GC: Clean	150 to 4050 (100mm pitch)	3L: 3.5m 5L: 5m 10L: 10m 3K/5K/10K (Flexible cable) ^{Note 4}

TSP

Positioner	Driver: Power-supply voltage / Power capacity	Regenerative unit	LCD monitor	I/O selection
Note 5 TS-P	110: 100V/200W 210: 200V/200W	R: With RGT	No entry: None L: With LCD	N: NPN PN: PNP CC: CC-Link DN: DeviceNet™ EP: EtherNet/IP™ GW: No I/O board ^{Note 6}

SR1-P 10

Controller	Driver: Power capacity	Usable for CE	Regenerative unit	I/O selection
	10: 200W	No entry: Standard E: CE marking	R: With RGT1	N: NPN P: PNP CC: CC-Link DN: DeviceNet™ PB: PROFIBUS

RDV-P 2 10 RBR1

Driver	Power-supply voltage	Driver: Power capacity	Regenerative unit
	2: AC200V	10: 200W or less	

Note 1. For the details of the semi-absolute model, please refer to P.39. RDV-P has an incremental model only.
 Note 2. For models with a 2,050mm or longer stroke, optional L type cable carriers can only be used.
 Note 3. The robot cable is standard cable (3L/5L/10L), but can be changed to flexible cable. See P.614 for details on robot cable.
 Note 4. If a flexible cable is needed for the SR1-P, TS-P, or RDV-P, then select 3K/5K/10K. On the RCX221, the standard cable is a flexible cable, so enter 3L/5L/10L when ordering.
 Note 5. These controllers can be mounted on DIN rails. See P.522 for details.
 Note 6. Select this selection when using the gateway function. For details, see P.66.
 Note. It is possible to provide the model without a cable carrier. To find information on wiring (cable terminals) within the cable carrier see P.622.

Double carriage model

MF20D

Model	Installing direction	Optional cable carrier for users ^{Note 2}	Grease type	Stroke	Cable length	Controller
MF20D: Incremental MF20AD: Semi-absolute ^{Note 1}	H: Horizontal installation W: Wall mount installation	No entry: None S: S type M: M type L: L type	No entry: Standard GC: Clean	150 to 3850 (100mm pitch)	3L: 3.5m 5L: 5m 10L: 10m 3K/5K/10K (Flexible cable) ^{Note 4}	RCX320 RCX221 SR1-P (2 units) TS-P (2 units) RDV-P (2 units)

Note. Specify various controller setting items.

Specifications

Model	MF20	MF20D
Driving method	Steel cored linear motor with falt magnet	
Repeatability (µm)	+/-5	
Scale (µm)	Magnetic type: resolution of 1	
Maximum speed ^{Note 2} (mm/sec)	2500	
Rated thrust (N)	86	
Maximum payload ^{Note 1} (kg)	40	
Stroke (mm)	150 to 4050 (100mm pitch)	150 to 3850 (100mm pitch)
Linear guide	4 rows of circular arc grooves x 2 rail W150 x H80	
Maximum cross-section outside dimensions (mm)	(except the cable carrier section)	
Total length (mm)	Stroke+260	Stroke+460
Cable length (m)	Standard: 3.5 / Option: 5.10	

Note. A vertical model (with brake) is not available with the PHASER series.
 Note. The basic specifications of semi-absolute model are the same as those of the incremental model.
 Note 1. Payload per carrier. When the payload exceeds 20kg, please consult our sales office or sales representative.
 Note 2. Table of maximum speed

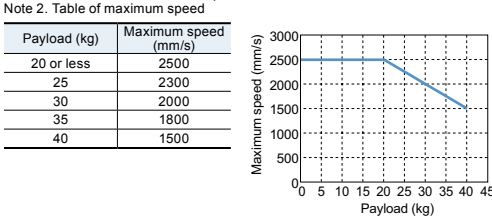

Allowable overhang

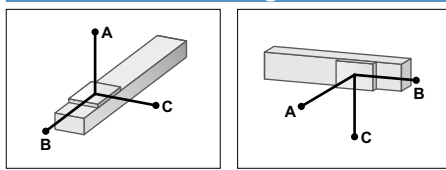

	Horizontal installation (Unit: mm)			Wall installation (Unit: mm)			
	A	B	C	A	B	C	
10kg	3156	1747	1196	10kg	1220	1320	2540
15kg	2811	1176	883	15kg	870	850	2200
20kg	2679	890	717	20kg	670	610	2030
25kg	2190	720	505	25kg	485	400	1280
30kg	1830	605	370	30kg	350	325	1050
35kg	1580	525	275	35kg	265	270	890
40kg	1390	465	225	40kg	235	230	765

Note. Distance from center of slider top to center of gravity of object being carried at a guide service life of 10,000 km.

Static loading moment

MY	MP	MR
373	373	328

(Unit: N·m)

Controller

Controller	Operating method
SR1-P10-R	Programming / I/O point trace / Remote command / Operation using RS-232C communication
RCX320-R RCX221-R RCX340	I/O point trace / Remote command
TS-P110-R TS-P210-R	Pulse train control

Cable carrier entry location

RH Horizontal, right **LH Horizontal, left**

RW Wall mounted, right **LW Wall mounted, left**

Note. Be sure to install in the direction as specified (in cable carrier take-out direction drawing and various specification drawings) individually. Installation in any other way will cause a failure. For requirement of installation in any way other than the above standard installation, please consult YAMAHA as special arrangement will be available.

Optional cable carrier for users

S type **M type** **L type**

Cable and air tube guide

S: φ8 flexible cable x 1, φ4 air tube x 1
 M: φ8 flexible cable x 2, φ6 air tube x 2
 L: φ8 flexible cable x 2, φ8 air tube x 3

Space for optional cable for users

MF20 single carriage horizontal mount model **RH**

Optional cable carrier S / M type
240.5 (M option)
215.5 (S option)

Optional cable carrier L type
238

Detail of section G

Cross-section of cable carrier
S, M, L

Grounding terminal (M4)

Table:

Effective stroke	150	250	350	450	550	650	750	850	950	1050	1150	1250	1350	1450	1550	1650	1750	1850	1950	2050	2150	2250	2350	2450	2550	2650	2750	2850	2950	3050	3150	3250	3350	3450	3550	3650	3750	3850	3950	4050																																																																																																																																																																																																																																																																																																																																																																																																																																																																																																																																																																																																																																																																																																																																																																																																																																																																																																																																																															
L	410	510	610	710	810	910	1010	1110	1210	1310	1410	1510	1610	1710	1810	1910	2010	2110	2210	2310	2410	2510	2610	2710	2810	2910	3010	3110	3210	3310	3410	3510	3610	3710	3810	3910	4010	410	4210	4310																																																																																																																																																																																																																																																																																																																																																																																																																																																																																																																																																																																																																																																																																																																																																																																																																																																																																																																																																															
A	105	55	105	55	105	55	105	55	105	55	105	55	105	55	105	55	105	55	105	55	105	55	105	55	105	55	105	55	105	55	105	55	105	55	105	55	105	55	105	55	105	55																																																																																																																																																																																																																																																																																																																																																																																																																																																																																																																																																																																																																																																																																																																																																																																																																																																																																																																																																													
B	1	2	2	3	3	4	4	5	5	6	6	7	7	8	8	9	9	10	10	11	11	12	12	13	13	14	14	15	15	16	16	17	17	18	18	19	19	20	20	21	21																																																																																																																																																																																																																																																																																																																																																																																																																																																																																																																																																																																																																																																																																																																																																																																																																																																																																																																																																														
C	4	6	6	8	8	10	10	12	12	14	14	16	16	18	18	20	20	22	22	24	24	26	26	28	28	30	30	32	32	34	34	36	36	38	38	40	40	42	42	44	44																																																																																																																																																																																																																																																																																																																																																																																																																																																																																																																																																																																																																																																																																																																																																																																																																																																																																																																																																														
D	200	300	400	500	600	700	800	900	1000	1100	1200	1300	1400	1500	1600	1700	1800	1900	2000	2100	2200	2300	2400	2500	2600	2700	2800	2900	3000	3100	3200	3300	3400	3500	3600	3700	3800	3900	4000	4100																																																																																																																																																																																																																																																																																																																																																																																																																																																																																																																																																																																																																																																																																																																																																																																																																																																																																																																																																															
Weight (kg)	8.4	10.1	11.7	13.3	15.0	16.6	18.2	19.8	21.5	23.1	24.7	26.2	27.8	29.3	30.9	32.4	33.9	35.3	36.8	38.3	39.7	41.1	42.5	43.9	45.3	46.7	48.1	49.5	50.9	52.3	53.7	55.1	56.5	57.9	59.3	60.7	62.1	63.5	64.9	66.3	67.7	69.1	70.5	71.9	73.3	74.7	76.1	77.5	78.9	80.3	81.7	83.1	84.5	85.9	87.3	88.7	90.1	91.5	92.9	94.3	95.7	97.1	98.5	99.9	101.3	102.7	104.1	105.5	106.9	108.3	109.7	111.1	112.5	113.9	115.3	116.7	118.1	119.5	120.9	122.3	123.7	125.1	126.5	127.9	129.3	130.7	132.1	133.5	134.9	136.3	137.7	139.1	140.5	141.9	143.3	144.7	146.1	147.5	148.9	150.3	151.7	153.1	154.5	155.9	157.3	158.7	160.1	161.5	162.9	164.3	165.7	167.1	168.5	169.9	171.3	172.7	174.1	175.5	176.9	178.3	179.7	181.1	182.5	183.9	185.3	186.7	188.1	189.5	190.9	192.3	193.7	195.1	196.5	197.9	199.3	200.7	202.1	203.5	204.9	206.3	207.7	209.1	210.5	211.9	213.3	214.7	216.1	217.5	218.9	220.3	221.7	223.1	224.5	225.9	227.3	228.7	230.1	231.5	232.9	234.3	235.7	237.1	238.5	239.9	241.3	242.7	244.1	245.5	246.9	248.3	249.7	251.1	252.5	253.9	255.3	256.7	258.1	259.5	260.9	262.3	263.7	265.1	266.5	267.9	269.3	270.7	272.1	273.5	274.9	276.3	277.7	279.1	280.5	281.9	283.3	284.7	286.1	287.5	288.9	290.3	291.7	293.1	294.5	295.9	297.3	298.7	300.1	301.5	302.9	304.3	305.7	307.1	308.5	309.9	311.3	312.7	314.1	315.5	316.9	318.3	319.7	321.1	322.5	323.9	325.3	326.7	328.1	329.5	330.9	332.3	333.7	335.1	336.5	337.9	339.3	340.7	342.1	343.5	344.9	346.3	347.7	349.1	350.5	351.9	353.3	354.7	356.1	357.5	358.9	360.3	361.7	363.1	364.5	365.9	367.3	368.7	370.1	371.5	372.9	374.3	375.7	377.1	378.5	379.9	381.3	382.7	384.1	385.5	386.9	388.3	389.7	391.1	392.5	393.9	395.3	396.7	398.1	399.5	400.9	402.3	403.7	405.1	406.5	407.9	409.3	410.7	412.1	413.5	414.9	416.3	417.7	419.1	420.5	421.9	423.3	424.7	426.1	427.5	428.9	430.3	431.7	433.1	434.5	435.9	437.3	438.7	440.1	441.5	442.9	444.3	445.7	447.1	448.5	449.9	451.3	452.7	454.1	455.5	456.9	458.3	459.7	461.1	462.5	463.9	465.3	466.7	468.1	469.5	470.9	472.3	473.7	475.1	476.5	477.9	479.3	480.7	482.1	483.5	484.9	486.3	487.7	489.1	490.5	491.9	493.3	494.7	496.1	497.5	498.9	500.3	501.7	503.1	504.5	505.9	507.3	508.7	510.1	511.5	512.9	514.3	515.7	517.1	518.5	519.9	521.3	522.7	524.1	525.5	526.9	528.3	529.7	531.1	532.5	533.9	535.3	536.7	538.1	539.5	540.9	542.3	543.7	545.1	546.5	547.9	549.3	550.7	552.1	553.5	554.9	556.3	557.7	559.1	560.5	561.9	563.3	564.7	566.1	567.5	568.9	570.3	571.7	573.1	574.5	575.9	577.3	578.7	580.1	581.5	582.9	584.3	585.7	587.1	588.5	589.9	591.3	592.7	594.1	595.5	596.9	598.3	599.7	601.1	602.5	603.9	605.3	606.7	608.1	609.5	610.9	612.3	613.7	615.1	616.5	617.9	619.3	620.7	622.1	623.5	624.9	626.3	627.7	629.1	630.5	631.9	633.3	634.7	636.1	637.5	638.9	640.3	641.7	643.1	644.5	645.9	647.3	648.7	650.1	651.5	652.9	654.3	655.7	657.1	658.5	659.9	661.3	662.7	664.1	665.5	666.9	668.3	669.7	671.1	672.5	673.9	675.3	676.7	678.1	679.5	680.9	682.3	683.7	685.1	686.5	687.9	689.3	690.7	692.1	693.5	694.9	696.3	697.7	699.1	700.5	701.9	703.3	704.7	706.1	707.5	708.9	710.3	711.7	713.1	714.5	715.9	717.3	718.7	720.1	721.5	722.9	724.3	725.7	727.1	728.5	729.9	731.3	732.7	734.1	735.5	736.9	738.3	739.7	741.1	742.5	743.9	745.3	746.7	748.1	749.5	750.9	752.3	753.7	755.1	756.5	757.9	759.3	760.7	762.1	763.5	764.9	766.3	767.7	769.1	770.5	771.9	773.3	774.7	776.1	777.5	778.9	780.3	781.7	783.1	784.5	785.9	787.3	788.7	790.1	791.5	792.9	794.3	795.7	797.1	798.5	799.9	801.3	802.7	804.1	805.5	806.9	808.3	809.7	811.1	812.5	813.9	815.3	816.7	818.1	819.5	820.9	822.3	823.7	825.1	826.5	827.9	829.3	830.7	832.1	833.5	834.9	836.3	837.7	839.1	840.5	841.9	843.3	844.7	846.1	847.5	848.9	850.3	851.7	853.1	854.5	855.9	857.3	858.7	860.1	861.5	862.9	864.3	865.7	867.1	868.5	869.9	871.3	872.7	874.1	875.5	876.9	878.3	879.7	881.1	882.5	883.9	885.3	886.7	888.1	889.5	890.9	892.3	893.7	895.1	896.5	897.9	899.3	900.7	902.1	903.5	904.9	906.3	907.7	909.1	910.5	911.9	913.3	914.7	916.1	917.5	918.9	920.3	921.7	923.1	924.5	925.9	927.3	928.7	930.1	931.5	932.9	934.3	935.7	937.1	938.5	939.9	941.3	942.7	944.1	945.5	946.9	948.3	949.7	951.1	952.5	953.9	955.3	956.7	958.1	959.5	960.9	962.3	963.7	965.1	966.5	967.9	969.3	970.7	972.1	973.5	974.9	976.3	977.7	979.1	980.5	981.9	983.3	984.7	986.1	987.5	988.9	990.3	991.7	993.1	994.5	995.9	997.3	998.7	1000.1	1001.5	1002.9	1004.3	1005.7	1007.1	1008.5	1009.9	1011.3	1012.7	1014.1	1015.5	1016.9	1018.3	1019.7	1021.1	1022.5	1023.9	1025.3	1026.7	1028.1	1029.5	1030.9	1032.3	1033.7	1035.1	1036.5	1037.9	1039.3	1040.7	1042.1	1043.5	1044.9	1046.3	1047.7	1049.1	1050.5	1051.9	1053.3	1054.7	1056.1	1057.5	1058.9	1060.3	1061.7	1063.1	1064.5	1065.9	1067.3	1068.7	1070.1	1071.5	1072.9	1074.3	1075.7	1077.1	1078.5	1079.9	1081.3	1082.7	1084.1	1085.5	1086.9	1088.3	1089.7	1091.1	1092.5	1093.9	1095.3	1096.7	1098.1	1099.5	1100.9	1102.3	1103.7	1105.1	1106.5	1107.9	1109.3	1110.7	1112.1	1113.5	1114.9	1116.3	1117.7	1119.1	1120.5	1121.9	1123.3	1124.7	1126.1	1127.5	1128.9	1130.3	1131.7	1133.1	1134.5	1135.9	1137.3	1138.7	1140.1	1141.5	1142.9	1144.3	1145.7	1147.1	1148.5	1149.9	1151.3	1152.7	1154.1	1155.5	1156.9	1158.3	1159.7	1161.1	1162.5	1163.9	1165.3	1166.7	1168.1	1169.5	1170.9	1172.3	1173.7	1175.1	1176.5	1177.9	1179.3	1180.7	1182.1	1183.5	1184.9	1186.3	1187.7	1189.1	1190.5	1191.9	1193.3	1194.7	1196.1	1197.5	1198.9	1200.3	1201.7	1203.1	1204.5	1205.9	1207.3	1208.7	1210.1	1211.5	1212.9	1214.3	1215.7	1217.1	1218.5	1219.9	1221.3	1222.7	1224.1	1225.5	1226.9	1228.3	1229.7	1231.1	1232.5	1233.9	1235.3	1236.7	1238.1	1239.5	1240.9	1242.3	1243.7	1245.1	1246.5	1247.9	1249.3	1250.7	1252.1	1253.5	1254.9	1256.3	1257.7	1259.1	1260.5	1261.9	1263.3	1264.7	1266.1	1267.5	1268.9	1270.3	1271.7	1273.1	1274.5	1275.9	1277.3	1278.7	1280.1	1281.5	1282.9	1284.3	1285.7	1287.1	1288.5	1289.9	1291.3	1292.7	1294.1	1295.5	1296.9	1298.3	1299.7	1301.1	1302.5	1303.9	1305.3	1306.7	1308.1	1309.5	1310.9	1312.3	1313.7	1315.1	1316.5	1317.9	1319.3	1320.7	1322.1	1323.5	1324.9	1326.3	1327.7	1329.1	1330.5	1331.9	1333.3	1334.7	1336.1	1337.5	1338.9	1340.3	1341.7	1343.1	1344.5	1345.9	1347.3	1348.7	1350.1	1351.5	1352.9	1354.3	1355.7	1357.1	1358.5	1359.9	1361.3	1362.7	1

MF20D double carriage horizontal mount model H

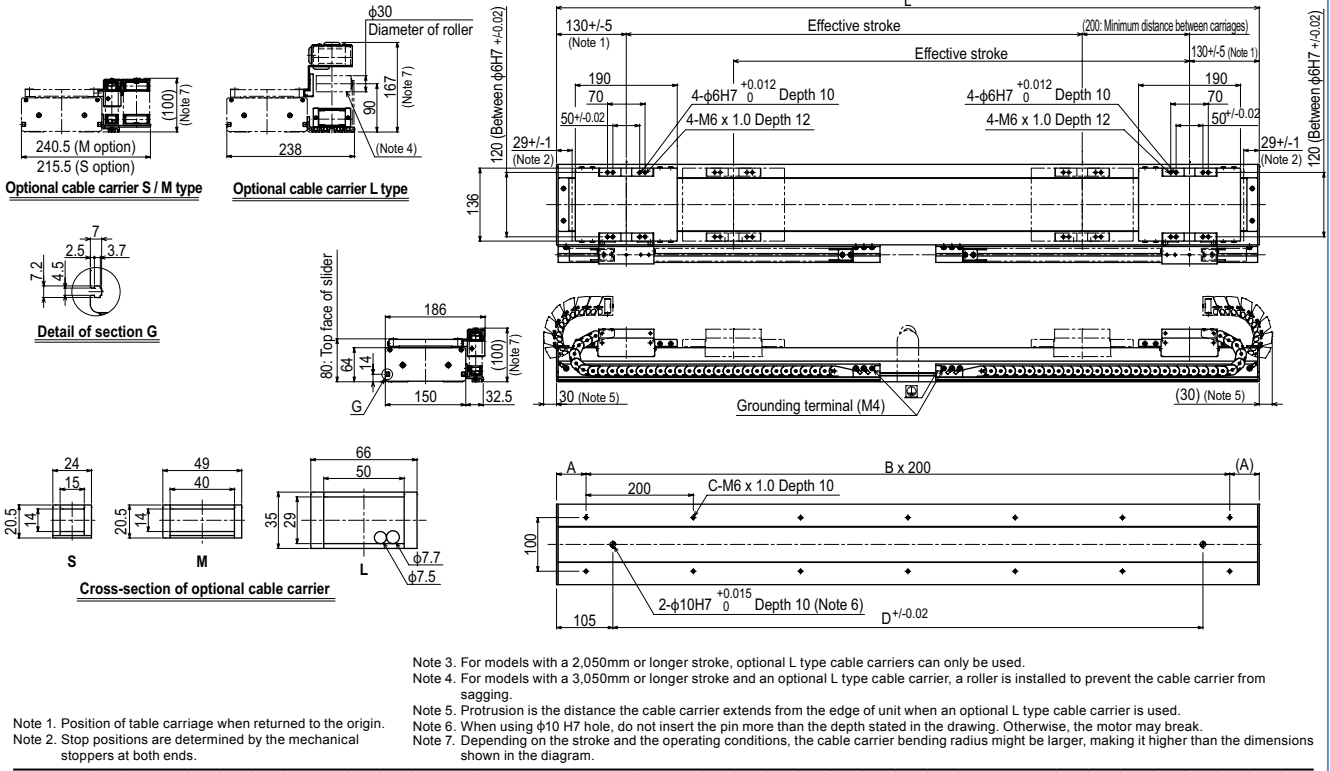

Effective stroke	150	250	350	450	550	650	750	850	950	1050	1150	1250	1350	1450	1550	1650	1750	1850	1950	2050	2150	2250	2350	2450	2550	2650	2750	2850	2950	3050	3150	3250	3350	3450	3550	3650	3750	3850		
L	610	710	810	910	1010	1110	1210	1310	1410	1510	1610	1710	1810	1910	2010	2110	2210	2310	2410	2510	2610	2710	2810	2910	3010	3110	3210	3310	3410	3510	3610	3710	3810	3910	4010	4110	4210	4310		
A	105	55	105	55	105	55	105	55	105	55	105	55	105	55	105	55	105	55	105	55	105	55	105	55	105	55	105	55	105	55	105	55	105	55	105	55	105	55	105	55
B	2	3	3	4	4	5	5	6	6	7	7	8	8	9	9	10	10	11	11	12	12	13	13	14	14	15	15	16	16	17	17	18	18	19	19	20	20	21	21	
C	6	8	8	10	10	12	12	14	14	16	16	18	18	20	20	22	22	24	24	26	26	28	28	30	30	32	32	34	34	36	36	38	38	40	40	42	42	44	44	
D	400	500	600	700	800	900	1000	1100	1200	1300	1400	1500	1600	1700	1800	1900	2000	2100	2200	2300	2400	2500	2600	2700	2800	2900	3000	3100	3200	3300	3400	3500	3600	3700	3800	3900	4000	4100		
Weight (kg)	14.9	16.6	18.3	20.0	21.7	23.5	25.2	26.9	28.6	30.3	32.0	33.7	35.4	37.1	38.8	40.5	42.2	43.9	45.6	47.3	49.0	50.7	52.4	54.1	55.8	57.5	59.2	60.9	62.6	64.3	66.0	67.7	69.4	71.1	72.8	74.5	76.2	77.9		

MF20D double carriage wall mount model W

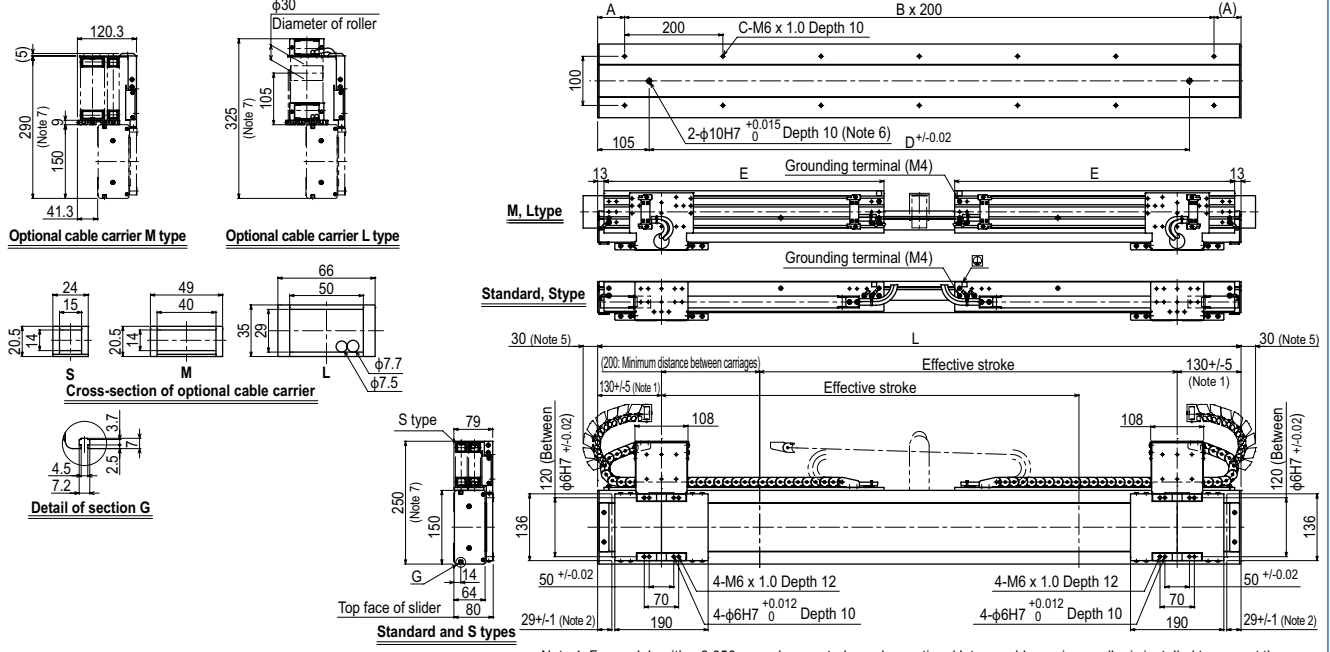

Effective stroke	150	250	350	450	550	650	750	850	950	1050	1150	1250	1350	1450	1550	1650	1750	1850	1950	2050	2150	2250	2350	2450	2550	2650	2750	2850	2950	3050	3150	3250	3350	3450	3550	3650	3750	3850		
L	610	710	810	910	1010	1110	1210	1310	1410	1510	1610	1710	1810	1910	2010	2110	2210	2310	2410	2510	2610	2710	2810	2910	3010	3110	3210	3310	3410	3510	3610	3710	3810	3910	4010	4110	4210	4310		
A	105	55	105	55	105	55	105	55	105	55	105	55	105	55	105	55	105	55	105	55	105	55	105	55	105	55	105	55	105	55	105	55	105	55	105	55	105	55	105	55
B	2	3	3	4	4	5	5	6	6	7	7	8	8	9	9	10	10	11	11	12	12	13	13	14	14	15	15	16	16	17	17	18	18	19	19	20	20	21	21	
C	6	8	8	10	10	12	12	14	14	16	16	18	18	20	20	22	22	24	24	26	26	28	28	30	30	32	32	34	34	36	36	38	38	40	40	42	42	44	44	
D	400	500	600	700	800	900	1000	1100	1200	1300	1400	1500	1600	1700	1800	1900	2000	2100	2200	2300	2400	2500	2600	2700	2800	2900	3000	3100	3200	3300	3400	3500	3600	3700	3800	3900	4000	4100		
E	220	270	320	370	420	470	520	570	620	670	720	770	820	870	920	970	1020	1070	1120	1170	1220	1270	1320	1370	1420	1470	1520	1570	1620	1670	1720	1770	1820	1870	1920	1970	2020	2070		
Weight (kg)	14.9	16.6	18.3	20.0	21.7	23.5	25.2	26.9	28.6	30.3	32.0	33.7	35.4	37.1	38.8	40.5	42.2	43.9	45.6	47.3	49.0	50.7	52.4	54.1	55.8	57.5	59.2	60.9	62.6	64.3	66.0	67.7	69.4	71.1	72.8	74.5	76.2	77.9		

MF30/MF30D

● Can be used for wall-mount



Ordering method

Single carriage model

MF30

Model	Cable carrier entry location	Optional cable carrier for users ^{Note 2}	Origin position change	Grease type	Stroke	Cable length
MF30: Incremental MF30A: Semi-absolute ^{Note 1}	RH: Horizontal, right LH: Horizontal, left RW: Wall mount, right LW: Wall mount, left	No entry: None S: S type M: M type L: L type	No entry: L side (Standard) Z: R side No entry: R side (Standard) Z: L side	No entry: Standard GC: Clean	100 to 4000 (100mm pitch)	3L: 3.5m 5L: 5m 10L: 10m 3K/5K/10K (Flexible cable) ^{Note 4}

TSP 220 R

Positioner	Driver: Power-supply voltage / Power capacity	Regenerative unit	LCD monitor	I/O selection
TS-P	220: 200V/400 to 600W	R: With RGT	No entry: None L: With LCD	NP: NPN PN: PNP CC: CC-Link DN: DeviceNet™ EP: EtherNet/IP™ GW: No I/O board ^{Note 5}

SR1-P 20 R

Controller	Driver: Power capacity	Usable for CE	Regenerative unit	I/O selection
	20: 400 to 600W	No entry: Standard E: CE marking	R: With RGT	N: NPN P: PNP CC: CC-Link DN: DeviceNet™ EP: EtherNet/IP™ PB: PROFIBUS

RDV-P 2 RBR1

Driver	Power-supply voltage	Driver: Power capacity	Regenerative unit
	2: AC200V	20: 400W or less	

- Note 1. For the details of the semi-absolute model, please refer to P.39. RDV-P has an incremental model only.
- Note 2. For models with a stroke of 2100 or longer (2050 or longer for double carriage models), only the optional L type cable carriers can be used.
- Note 3. The robot cable is standard cable (3L/5L/10L), but can be changed to flexible cable. See P.614 for details on robot cable.
- Note 4. If a flexible cable is needed for the SR1-P, TS-P, or RDV-P, then select 3K/5K/10K. On the RCX221HP, the standard cable is a flexible cable, so enter 3L/5L/10L when ordering.
- Note 5. These controllers can be mounted on DIN rails. See P.522 for details.
- Note 6. Select this selection when using the gateway function. For details, see P.66.
- Note. It is possible to provide the model without a cable carrier. To find information on wiring (cable terminals) within the cable carrier see P.622.

Double carriage model

MF30D

Model	Installing direction	Optional cable carrier for users ^{Note 2}	Grease type	Stroke	Cable length	Controller
MF30D: Incremental MF30AD: Semi-absolute ^{Note 1}	H: Horizontal installation W: Wall mount installation	No entry: None S: S type M: M type L: L type	No entry: Standard GC: Clean	150 to 3750 (100mm pitch)	3L: 3.5m 5L: 5m 10L: 10m 3K/5K/10K (Flexible cable) ^{Note 4}	RCX320 RCX221HP SR1-P (2 units) TS-P (2 units) RDV-P (2 units)

Note. Specify various controller setting items.

Specifications

Model	MF30	MF30D
Driving method	Steel cored linear motor with falt magnet	
Repeatability (μm)	+/-5	
Scale (μm)	Magnetic type: resolution of 1	
Maximum speed ^{Note 2} (mm/sec)	2500	
Rated thrust (N)	125	
Maximum payload ^{Note 1} (kg)	60	
Stroke (mm)	100 to 4000 (100mm pitch)	150 to 3750 (100mm pitch)
Linear guide	4 rows of circular arc grooves x 2 rail	
Maximum cross-section outside dimensions (mm)	W150 x H80 (except the cable carrier section)	
Total length (mm)	Stroke+310	Stroke+560
Cable length (m)	Standard: 3.5 / Option: 5,10	

- Note. A vertical model (with brake) is not available with the PHASER series.
- Note. The basic specifications of semi-absolute model are the same as those of the incremental model.
- Note 1. Payload per carrier. When the payload exceeds 30kg, please consult our sales office or sales representative.
- Note 2. Table of maximum speed

Payload (kg)	Maximum speed (mm/s)
30 or less	2500
40	2200
50	1800
60	1500

Allowable overhang

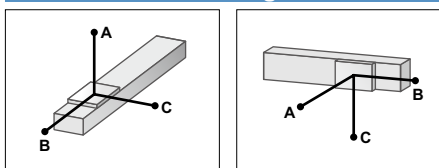

	Horizontal installation (Unit: mm)			Wall installation (Unit: mm)		
	A	B	C	A	B	C
10kg	3364	2485	1284	1290	1320	2730
20kg	2298	1265	694	650	610	1750
30kg	2060	859	507	430	360	1460
40kg	1570	600	310	205	230	610
50kg	1265	400	180	145	175	470
60kg	1070	350	135	105	140	380

Note. Distance from center of slider top to center of gravity of object being carried at a guide service life of 10,000 km.

Static loading moment

MY	MP	MR
373	373	328

(Unit: N-m)

Controller

Controller	Operating method
SR1-P20-R	Programming / I/O point trace / Remote command / Operation using RS-232C communication
RCX320-R RCX221HP-R RCX340	I/O point trace / Remote command
TS-P220-R	Pulse train control
RDV-P220-RBR1	

Cable carrier entry location

RH Horizontal, right **LH Horizontal, left**

RW Wall mounted, right **LW Wall mounted, left**

Note. Be sure to install in the direction as specified (in cable carrier take-out direction drawing and various specification drawings) individually. Installation in any other way will cause a failure. For requirement of installation in any way other than the above standard installation, please consult YAMAHA as special arrangement will be available.

Optional cable carrier for users

S type **M type** **L type**

Cable and air tube guide

S: φ8 flexible cable x 1, φ4 air tube x 1
M: φ8 flexible cable x 2, φ6 air tube x 2
L: φ8 flexible cable x 2, φ8 air tube x 3

Space for optional cable for users

Controller

SR1-P ▶ 540 **RCX320 ▶ 548** **RCX221 ▶ 558** **TS-P ▶ 514** **RDV-P ▶ 528**

MF30D double carriage horizontal mount model **H**

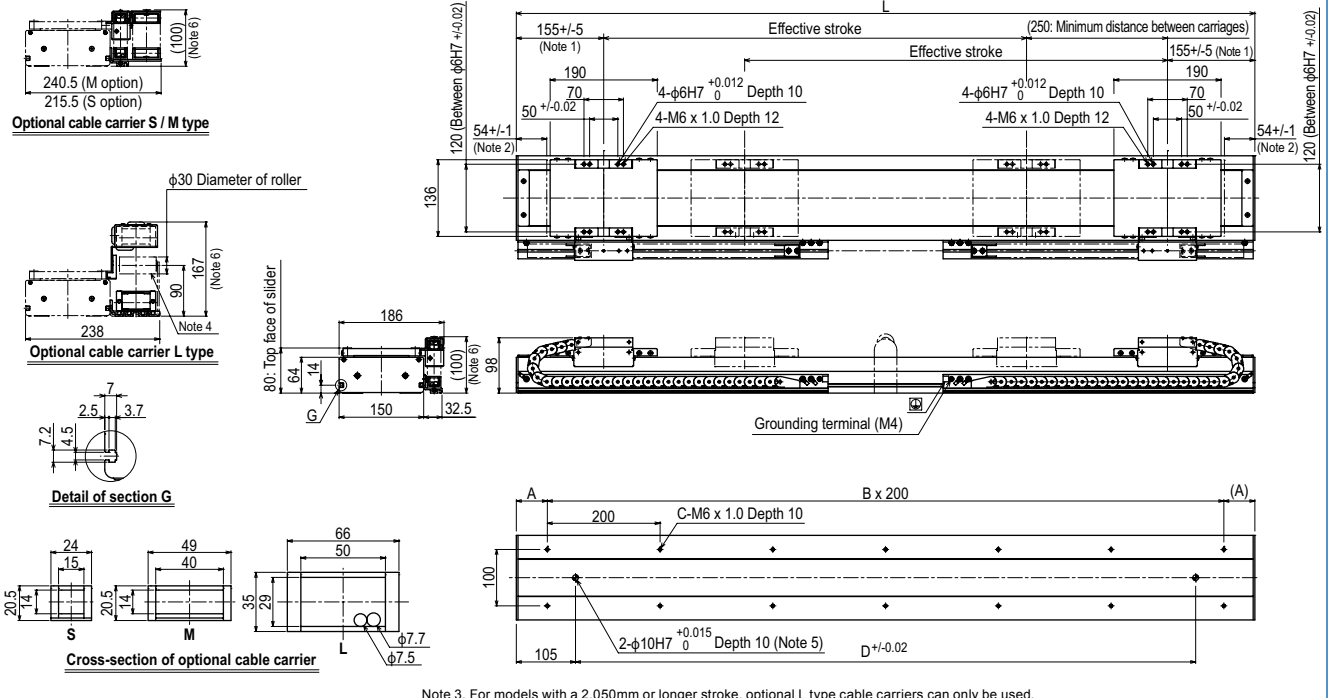

Note 1. Position of table carriage when returned to the origin.
 Note 2. Stop positions are determined by the mechanical stoppers at both ends.
 Note 3. For models with a 2,050mm or longer stroke, optional L type cable carriers can only be used.
 Note 4. For models with a 3,050mm or longer stroke and an optional L type cable carrier, a roller is installed to prevent the cable carrier from sagging.
 Note 5. When using φ10 H7 hole, do not insert the pin more than the depth stated in the drawing. Otherwise, the motor may break.
 Note 6. Depending on the stroke and the operating conditions, the cable carrier bending radius might be larger, making it higher than the dimensions shown in the diagram.

Effective stroke	150	250	350	450	550	650	750	850	950	1050	1150	1250	1350	1450	1550	1650	1750	1850	1950	2050	2150	2250	2350	2450	2550	2650	2750	2850	2950	3050	3150	3250	3350	3450	3550	3650	3750		
L	710	810	910	1010	1110	1210	1310	1410	1510	1610	1710	1810	1910	2010	2110	2210	2310	2410	2510	2610	2710	2810	2910	3010	3110	3210	3310	3410	3510	3610	3710	3810	3910	4010	4110	4210	4310		
A	55	105	55	105	55	105	55	105	55	105	55	105	55	105	55	105	55	105	55	105	55	105	55	105	55	105	55	105	55	105	55	105	55	105	55	105	55	105	55
B	3	3	4	4	5	5	6	6	7	7	8	8	9	9	10	10	11	11	12	12	13	13	14	14	15	15	16	16	17	17	18	18	19	19	20	20	21	21	
C	8	8	10	10	12	12	14	14	16	16	18	18	20	20	22	22	24	24	26	26	28	28	30	30	32	32	34	34	36	36	38	38	40	40	42	42	44	44	
D	500	600	700	800	900	1000	1100	1200	1300	1400	1500	1600	1700	1800	1900	2000	2100	2200	2300	2400	2500	2600	2700	2800	2900	3000	3100	3200	3300	3400	3500	3600	3700	3800	3900	4000	4100	4200	
Weight (kg)	17.6	19.3	21.0	22.2	24.2	25.2	27.7	29.9	29.6	31.3	33.3	33.4	35.3	37.3	39.9	41.4	43.4	45.4	45.0	25.1	9.53	6.55	3.57	0.58	7.60	4.62	1.63	9.65	6.67	3.69	0.70	7.72	4.74	1.75	8.77	5.79	3.93		

MF30D double carriage wall mount model **W**

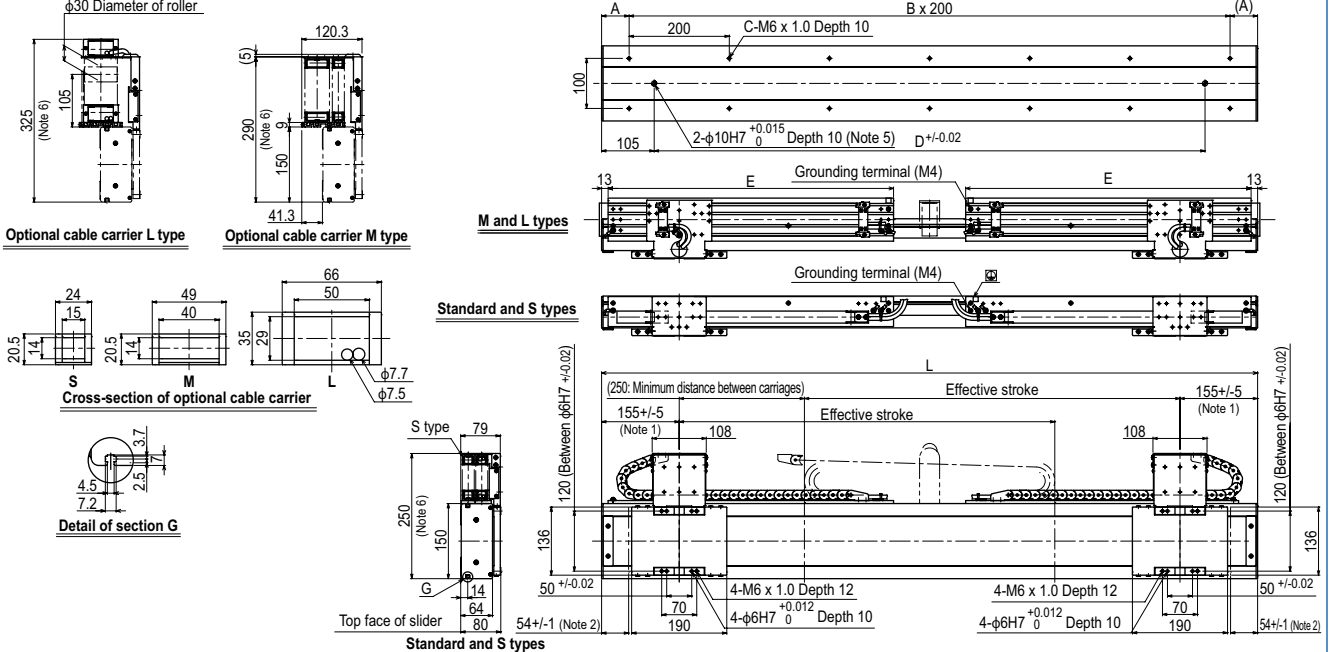

Note 1. Position of table carriage when returned to the origin.
 Note 2. Stop positions are determined by the mechanical stoppers at both ends.
 Note 3. For models with a 2,050mm or longer stroke, optional L type cable carriers can only be used.
 Note 4. For models with a 3,050mm or longer stroke and an optional L type cable carrier, a roller is installed to prevent the cable carrier from sagging.
 Note 5. When using φ10 H7 hole, do not insert the pin more than the depth stated in the drawing. Otherwise, the motor may break.
 Note 6. Depending on the stroke and the operating conditions, the cable carrier bending radius might be larger, making it higher than the dimensions shown in the diagram.

Effective stroke	150	250	350	450	550	650	750	850	950	1050	1150	1250	1350	1450	1550	1650	1750	1850	1950	2050	2150	2250	2350	2450	2550	2650	2750	2850	2950	3050	3150	3250	3350	3450	3550	3650	3750		
L	710	810	910	1010	1110	1210	1310	1410	1510	1610	1710	1810	1910	2010	2110	2210	2310	2410	2510	2610	2710	2810	2910	3010	3110	3210	3310	3410	3510	3610	3710	3810	3910	4010	4110	4210	4310		
A	55	105	55	105	55	105	55	105	55	105	55	105	55	105	55	105	55	105	55	105	55	105	55	105	55	105	55	105	55	105	55	105	55	105	55	105	55	105	55
B	3	3	4	4	5	5	6	6	7	7	8	8	9	9	10	10	11	11	12	12	13	13	14	14	15	15	16	16	17	17	18	18	19	19	20	20	21	21	
C	8	8	10	10	12	12	14	14	16	16	18	18	20	20	22	22	24	24	26	26	28	28	30	30	32	32	34	34	36	36	38	38	40	40	42	42	44	44	
D	500	600	700	800	900	1000	1100	1200	1300	1400	1500	1600	1700	1800	1900	2000	2100	2200	2300	2400	2500	2600	2700	2800	2900	3000	3100	3200	3300	3400	3500	3600	3700	3800	3900	4000	4100	4200	
E	220	270	320	370	420	470	520	570	620	670	720	770	820	870	920	970	1020	1070	1120	1170	1220	1270	1320	1370	1420	1470	1520	1570	1620	1670	1720	1770	1820	1870	1920	1970	2020		
Weight (kg)	17.6	19.3	21.0	22.2	24.2	25.2	27.7	29.9	29.6	31.3	33.3	33.4	35.3	37.3	39.9	41.4	43.4	45.4	45.0	25.1	9.53	6.55	3.57	0.58	7.60	4.62	1.63	9.65	6.67	3.69	0.70	7.72	4.74	1.75	8.77	5.79	3.93		

MF75/MF75D



Ordering method

Single carriage model

MF75

Model MF75: Incremental MF75A: Semi-absolute ^{Note 1}	Cable carrier entry location RH: Horizontal, right LH: Horizontal, left	Origin position change No entry: L side (Standard) Z: R side	Grease type No entry: Standard GC: Clean	Stroke 1000 to 4000 (100mm pitch)	Cable length ^{Note 2} 3L: 3.5m 5L: 5m 10L: 10m 3K/5K/10K (Flexible cable) ^{Note 3}	TSP Positioner ^{Note 4} TS-P	220 Driver: Power-supply voltage / Power capacity 220: 200V/400 to 600W	R Regenerative unit R: With RGU-2	LCD monitor No entry: None L: With LCD	I/O selection NP: NPN PN: PNP CC: CC-Link DN: DeviceNet™ EP: EtherNet/IP™ GW: No I/O board ^{Note 5}
---	--	---	---	---	---	---	---	---	---	---

SR1-P

Controller	20 Driver: Power capacity 20: 400 to 600W	Usable for CE No entry: Standard E: CE marking	R Regenerative unit R: With RGU-2	I/O selection N: NPN P: PNP CC: CC-Link DN: DeviceNet™ PB: PROFIBUS
-------------------	---	---	---	---

RDV-P

Driver	2 Power-supply voltage 2: AC200V	25 Driver: Power capacity 25: 750W or less	RBR2 Regenerative unit
---------------	--	--	---

- Note 1. For the details of the semi-absolute model, please refer to P.39. RDV-P has an incremental model only.
- Note 2. The robot cable is standard cable (3L/5L/10L), but can be changed to flexible cable. See P.614 for details on robot cable.
- Note 3. If a flexible cable is needed for the SR1-P, TS-P, or RDV-P, then select 3K/5K/10K. On the RCX221HP, the standard cable is a flexible cable, so enter 3L/5L/10L when ordering.
- Note 4. These controllers can be mounted on DIN rails. See P.522 for details.
- Note 5. Select this selection when using the gateway function. For details, see P.66.
- Note. It is possible to provide the model without a cable carrier. To find information on wiring (cable terminals) within the cable carrier see P.622.

Double carriage model

MF75D - **H**

Model MF75D: Incremental MF75AD: Semi-absolute ^{Note 1}	Installing direction H: Horizontal installation	Grease type No entry: Standard GC: Clean	Stroke 680 to 3680 (100mm pitch)	Cable length 3L: 3.5m 5L: 5m 10L: 10m 3K/5K/10K (Flexible cable) ^{Note 3}	Controller RCX320 RCX221HP SR1-P (2 units) TS-P (2 units) RDV-P (2 units)
---	---	---	--	---	---

Note. Specify various controller setting items.

Specifications ^{Note}

Model	MF75	MF75D
Driving method	Steel cored linear motor with falt magnet	
Repeatability (µm)	+/-5	
Scale (µm)	Magnetic type: resolution of 1	
Maximum speed ^{Note 2} (mm/sec)	2500	
Rated thrust (N)	260	
Maximum payload ^{Note 1} (kg)	160	
Stroke (mm)	1000 to 4000 (100mm pitch)	680 to 3680 (100mm pitch)
Linear guide	4 rows of circular arc grooves x 2 rail	
Maximum cross-section outside dimensions (mm)	W210xH100 (except the cable carrier section)	
Total length (mm)	Stroke+360	Stroke+680
Cable length (m)	Standard: 3.5 / Option: 5,10	

Note. A vertical model (with brake) is not available with the PHASER series.
Note. The basic specifications of semi-absolute model are the same as those of the incremental model.
Note 1. Payload per carrier. When the payload exceeds 75kg, please consult our sales office or sales representative.

Note 2. Table of maximum speed

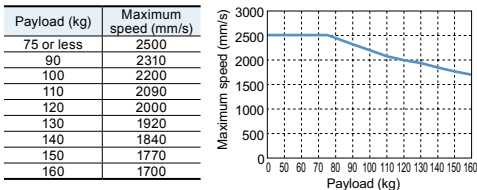

Allowable overhang ^{Note}

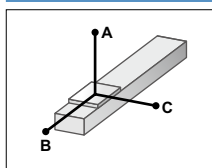

Horizontal installation (Unit: mm)

	A	B	C
20kg	3397	2841	1840
40kg	2795	1389	964
60kg	2200	530	450
80kg	1800	175	150
100kg	1500	130	110
120kg	1250	100	80
140kg	1100	80	65
160kg	950	60	50

Note. Distance from center of slider top to center of gravity of object being carried at a guide service life of 10,000 km.

Static loading moment

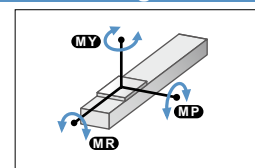

(Unit: N-m)

MY	MP	MR
830	831	730

Controller

Controller	Operating method
SR1-P20-R	Programming / I/O point trace /
RCX320-R	Remote command /
RCX221HP-R	Operation using RS-232C
RCX340	communication
TS-P220-R	I/O point trace / Remote command
RDV-P225-RBR2	Pulse train control

Cable carrier entry location

RH Horizontal, right **LH Horizontal, left**

Note. Be sure to install in the direction as specified (in cable carrier take-out direction drawing and various specification drawings) individually. Installation in any other way will cause a failure. For requirement of installation in any way other than the above standard installation, please consult YAMAHA as special arrangement will be available.

Cable carrier

Cable and air tube guide φ8 flexible cable x 2, φ6 air tube x 3

Space for optional cable for users

MF75 single carriage horizontal mount model **RH**

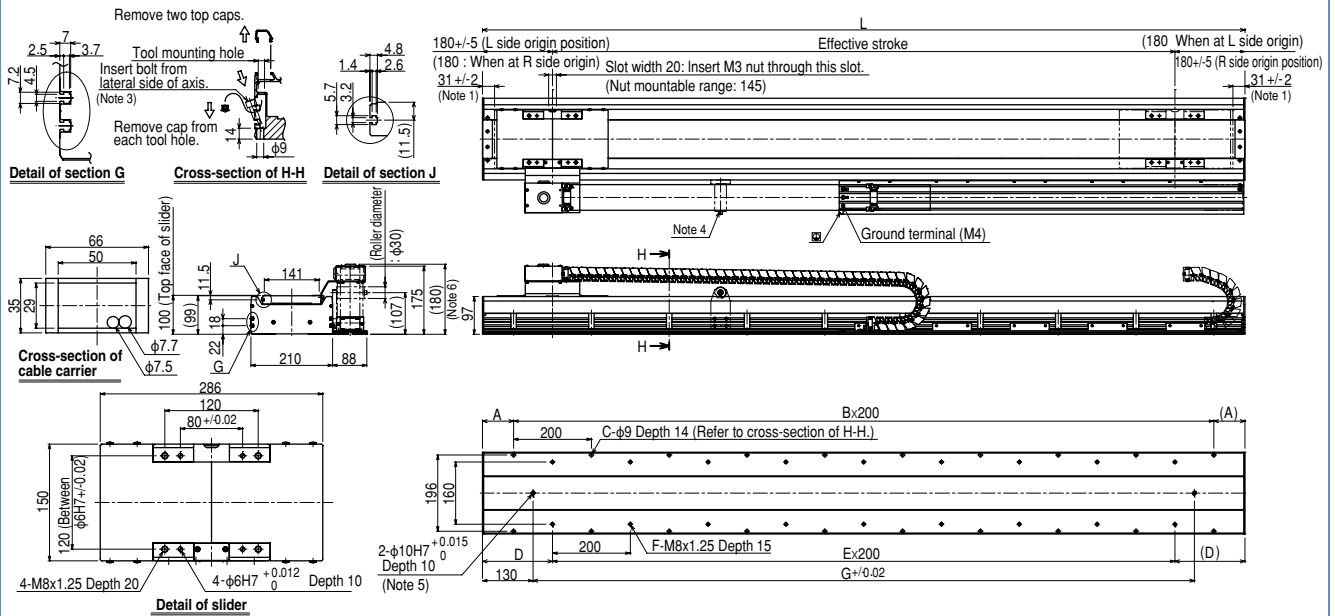

Note 1. Stop positions are determined by the mechanical stoppers at both ends.
 Note 2. The origin is set on the L side (as shown above) at the time of shipment. It can be changed to the R side by parameter setting.
 Note 3. The length under head of M8 hex socket head bolts for installing the robot body must not be longer than 30mm.
 Note 4. For models with a 3,000mm or longer stroke, a roller is installed to prevent the cable carrier from sagging.
 Note 5. When using $\phi 10$ H7 hole, do not insert the pin more than the depth stated in the drawing. Otherwise, the motor may break.
 Note 6. Depending on the stroke and the operating conditions, the cable carrier bending radius might be larger, making it higher than the dimensions shown in the diagram.

Effective stroke	1000	1100	1200	1300	1400	1500	1600	1700	1800	1900	2000	2100	2200	2300	2400	2500	2600	2700	2800	2900	3000	3100	3200	3300	3400	3500	3600	3700	3800	3900	4000
L	1360	1460	1560	1660	1760	1860	1960	2060	2160	2260	2360	2460	2560	2660	2760	2860	2960	3060	3160	3260	3360	3460	3560	3660	3760	3860	3960	4060	4160	4260	4360
A	180	230	80	130	180	230	80	130	180	230	80	130	180	230	80	130	180	230	80	130	180	230	80	130	180	230	80	130	180	230	80
B	5	5	7	7	7	7	9	9	9	9	11	11	11	11	13	13	13	13	13	15	15	15	17	17	17	17	19	19	19	19	21
C	12	12	16	16	16	16	20	20	20	24	24	24	24	28	28	28	28	28	32	32	32	32	32	36	36	36	36	40	40	40	44
D	80	130	180	230	80	130	180	230	80	130	180	230	80	130	180	230	80	130	180	230	80	130	180	230	80	130	180	230	80	130	180
E	6	6	6	6	8	8	8	8	10	10	10	10	12	12	12	12	14	14	14	14	16	16	16	16	18	18	18	18	20	20	20
F	14	14	14	14	18	18	18	18	22	22	22	22	26	26	26	26	30	30	30	30	34	34	34	34	38	38	38	38	42	42	42
G	1100	1200	1300	1400	1500	1600	1700	1800	1900	2000	2100	2200	2300	2400	2500	2600	2700	2800	2900	3000	3100	3200	3300	3400	3500	3600	3700	3800	3900	4000	4100
Weight (kg)	46	49	51	54	56	59	61	64	66	69	71	74	76	79	81	84	86	89	91	94	96	99	101	104	106	109	111	114	116	119	121

MF75D double carriage mount model **H**

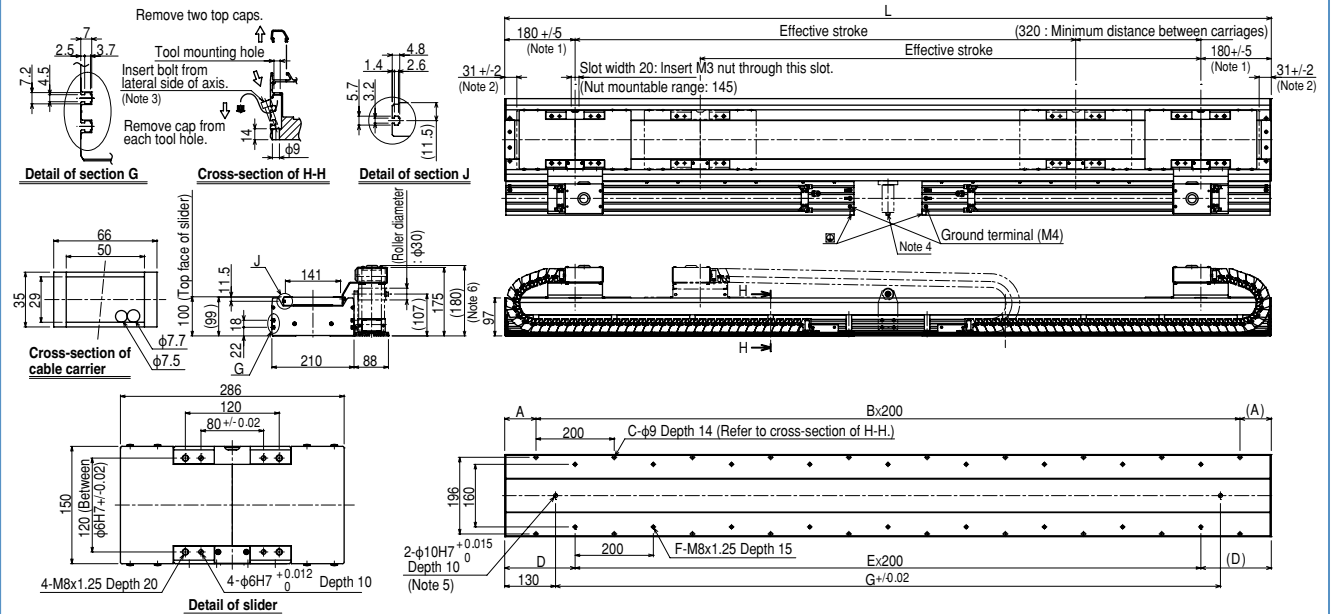

Note 1. Position of table carriage when returned to the origin.
 Note 2. Stop positions are determined by the mechanical stoppers at both ends.
 Note 3. The length under head of M8 hex socket head bolts for installing the robot body must not be longer than 30mm.
 Note 4. For models with a 3,080mm or longer stroke, a roller is installed to prevent the cable carrier from sagging.
 Note 5. When using $\phi 10$ H7 hole, do not insert the pin more than the depth stated in the drawing. Otherwise, the motor may break.
 Note 6. Depending on the stroke and the operating conditions, the cable carrier bending radius might be larger, making it higher than the dimensions shown in the diagram.

Effective stroke	680	780	880	980	1080	1180	1280	1380	1480	1580	1680	1780	1880	1980	2080	2180	2280	2380	2480	2580	2680	2780	2880	2980	3080	3180	3280	3380	3480	3580	3680
L	1360	1460	1560	1660	1760	1860	1960	2060	2160	2260	2360	2460	2560	2660	2760	2860	2960	3060	3160	3260	3360	3460	3560	3660	3760	3860	3960	4060	4160	4260	4360
A	180	230	80	130	180	230	80	130	180	230	80	130	180	230	80	130	180	230	80	130	180	230	80	130	180	230	80	130	180	230	80
B	5	5	7	7	7	7	9	9	9	9	11	11	11	11	13	13	13	13	13	15	15	15	17	17	17	17	19	19	19	19	21
C	12	12	16	16	16	16	20	20	20	24	24	24	24	28	28	28	28	28	32	32	32	32	32	36	36	36	36	40	40	40	44
D	80	130	180	230	80	130	180	230	80	130	180	230	80	130	180	230	80	130	180	230	80	130	180	230	80	130	180	230	80	130	180
E	6	6	6	6	8	8	8	8	10	10	10	10	12	12	12	12	14	14	14	14	16	16	16	16	18	18	18	18	20	20	20
F	14	14	14	14	18	18	18	18	22	22	22	22	26	26	26	26	30	30	30	30	34	34	34	34	38	38	38	38	42	42	42
G	1100	1200	1300	1400	1500	1600	1700	1800	1900	2000	2100	2200	2300	2400	2500	2600	2700	2800	2900	3000	3100	3200	3300	3400	3500	3600	3700	3800	3900	4000	4100
Weight (kg)	57	60	62	65	67	70	73	75	78	81	83	86	88	91	94	96	99	101	104	107	109	112	114	117	120	122	125	127	130	133	135

Articulated robots
 YA
 Linear conveyor modules
 LCM100
 Motor-less single axis actuator
 Robonity
 Compact single-axis robots
 TRANSEVO
 Single-axis robots
 FLIP-X
 Linear motor single-axis robots
 PHASER
 Cartesian robots
 XX-X
 SCARA robots
 YK-X
 Pick & place robots
 YP-X
 CLEAN
 CONTROLLER INFORMATION