

MA1

series



Product Segments

• Industrial Motion

TiMOTION's MA1 series linear actuator is the proven choice for applications requiring a durable, long life solution. Specifically designed for harsh working environments, the MA1 linear actuator is ideal for use in heavy-duty machinery, industrial equipment and off road vehicles. This linear actuator has been certified for applications requiring IP69K compliance. Available options for the MA1 linear actuator include AC or DC power, ball or acme spindles, mechanical or electrical braking and a load limiting clutch or limit switches.

General Features

Max. load	ACME screw: 2,500N (push / pull) Ball screw: 4,500N (push / pull)
Max. speed at max. load	14.3mm/s (ACME screw, DC motor) 14mm/s (Ball screw, DC motor)
Max. speed at no load	58.5mm/s (Ball screw, DC motor)
Retracted length	≥ Stroke + 160mm (ACME screw, without POT) ≥ Stroke + 201mm (Ball screw, without POT)
IP rating	IP69K
Certificate	UL73, EMC
Stroke	20~1000mm (ACME screw); 50~800mm (Ball screw)
Options	Overload clutch, electromagnetic brake, Hall sensors, POT, manual crank function
Voltage	12 / 24 / 36V DC; 110 / 220V AC
Spindle	ACME or Ball screw
Color	Black
Operational temperature range	-30°C~+65°C
Operational temperature range at full performance	+5°C~+45°C
Mechanical or electromagnetic brake	
Higher duty cycle (25%), corrosion proof	

Drawing

Standard Dimensions
(mm)

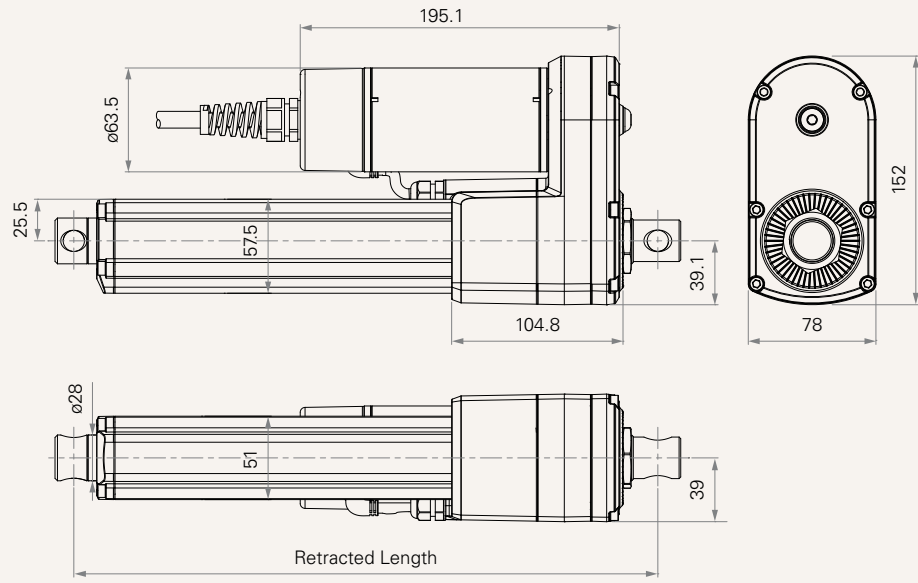

Load and Speed - DC Motor

ACME Screw

CODE	Load (N)		Self Locking Force (N)		Typical Current (A)				Typical Speed (mm/s)				Overload Clutch Range (N)
	Push	Pull	Mechanical Brake		No Load		With Load		No Load		With Load		
			Without	With	12VDC	24VDC	12VDC	24VDC	12VDC	24VDC	12VDC	24VDC	
Motor Speed (Duty Cycle 25%)													
B	1500	1500	500	1950	10.0	5.0	15.4	7.7	29.5	29.5	27.0	27.0	1800-3300
C	2500	2500	500	3250	5.0	2.5	14.0	7.0	15.8	15.8	14.3	14.3	3000-5500

Note

- The current & speed in table are tested with 24V DC motor. With a 12V DC motor, the current is approximately twice the current measured in 24V DC. With a 36V DC motor, the current is approximately two-thirds the current measured in 24V DC. Speed will be similar for all the voltages.
- The current & speed in table are tested when the actuator is extending under push load.
- Standard stroke: Min. ≥ 20 mm, Max. please refer to below table.

CODE	Load (N)	Max Stroke (mm)
B	1500	1000
C	2500	800

Ball Screw

CODE	Load (N)		Self Locking Force (N)		Typical Current (A)				Typical Speed (mm/s)				Overload Clutch Range (N)
	Push	Pull	Mechanical Brake		No Load		With Load		No Load		With Load		
			Without	With	12VDC	24VDC	12VDC	24VDC	12VDC	24VDC	12VDC	24VDC	
Motor Speed (Duty Cycle 25%)													
A	2500	2500	0	3250	7.0	3.5	30.0	12.5	58.5	58.5	36.5	48.0	3000-5500
B	3500	3500	0	4550	5.0	2.5	18.0	9.0	29.8	29.8	25.5	25.5	4200-7700
C	4500	4500	0	5850	4.0	2.0	13.0	6.5	16.0	16.0	14.0	14.0	5400-9900

Note

- The current & speed in table are tested with 24V DC motor. With a 12V DC motor, the current is approximately twice the current measured in 24V DC. With a 36V DC motor, the current is approximately two-thirds the current measured in 24V DC. Speed will be similar for all the voltages.
- The current & speed in table are tested when the actuator is extending under push load.
- Standard stroke: Min. ≥ 50 mm, Max. please refer to below table.

CODE	Load (N)	Max Stroke (mm)
A	2500	800
B	3500	600
C	4500	600

Load and Speed - AC Motor

ACME Screw

CODE	Load (N)		Self Locking Force (N)		Typical Current (A)				Typical Speed (mm/s)				Overload Clutch Range (N)
	Push	Pull	Mechanical Brake		No Load		With Load		No Load		With Load		
			Without	With	110VAC	220VAC	110VAC	220VAC	110VAC	220VAC	110VAC	220VAC	

Motor Speed (Duty Cycle 25%)

B	1500	1500	500	1950	1.9	0.9	2.0	1.0	26.1	22.5	23.0	21.0	1800-3300
C	2500	2500	500	3250	1.9	0.9	2.0	1.0	14.1	12.0	12.8	11.2	3000-5500

Note

1 The current & speed in table are tested when the actuator is extending under push load.

2 Standard stroke: Min. ≥ 20mm, Max. please refer to below table.

CODE	Load (N)	Max Stroke (mm)
B	1500	1000
C	2500	800

Ball Screw

CODE	Load (N)		Self Locking Force (N)		Typical Current (A)				Typical Speed (mm/s)				Overload Clutch Range (N)
	Push	Pull	Mechanical Brake		No Load		With Load		No Load		With Load		
			Without	With	110VAC	220VAC	110VAC	220VAC	110VAC	220VAC	110VAC	220VAC	

Motor Speed (Duty Cycle 25%)

A	2500	2500	0	3250	2.0	0.9	2.5	1.3	53.0	46.0	38.5	40.0	3000-5500
B	3500	3500	0	4550	1.9	0.9	2.1	1.1	27.0	23.5	22.5	21.5	4200-7700
C	4500	4500	0	5850	1.9	0.9	2.0	1.0	14.5	12.0	13.0	11.5	5400-9900

Note

1 The current & speed in table are tested when the actuator is extending under push load.

2 Standard stroke: Min. ≥ 20mm, Max. please refer to below table.

CODE	Load (N)	Max Stroke (mm)
A	2500	800
B	3500	600
C	4500	600

Performance Data (24V DC Motor)

ACME Screw (Duty Cycle 25%)

Speed vs. Load

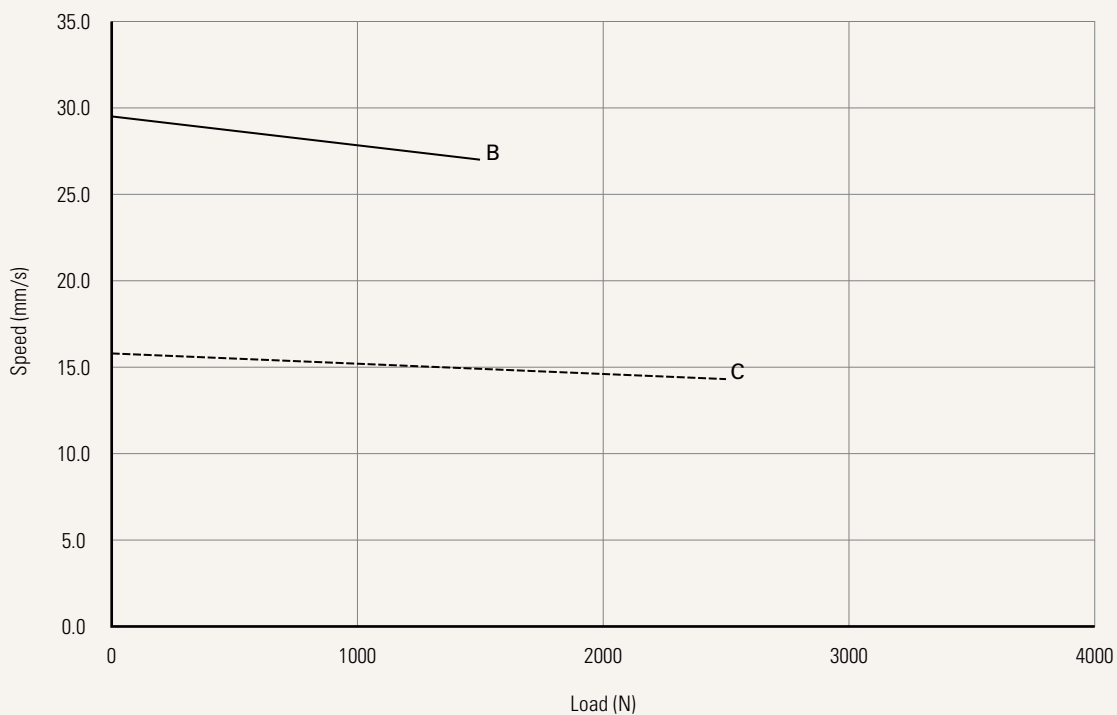

Current vs. Load

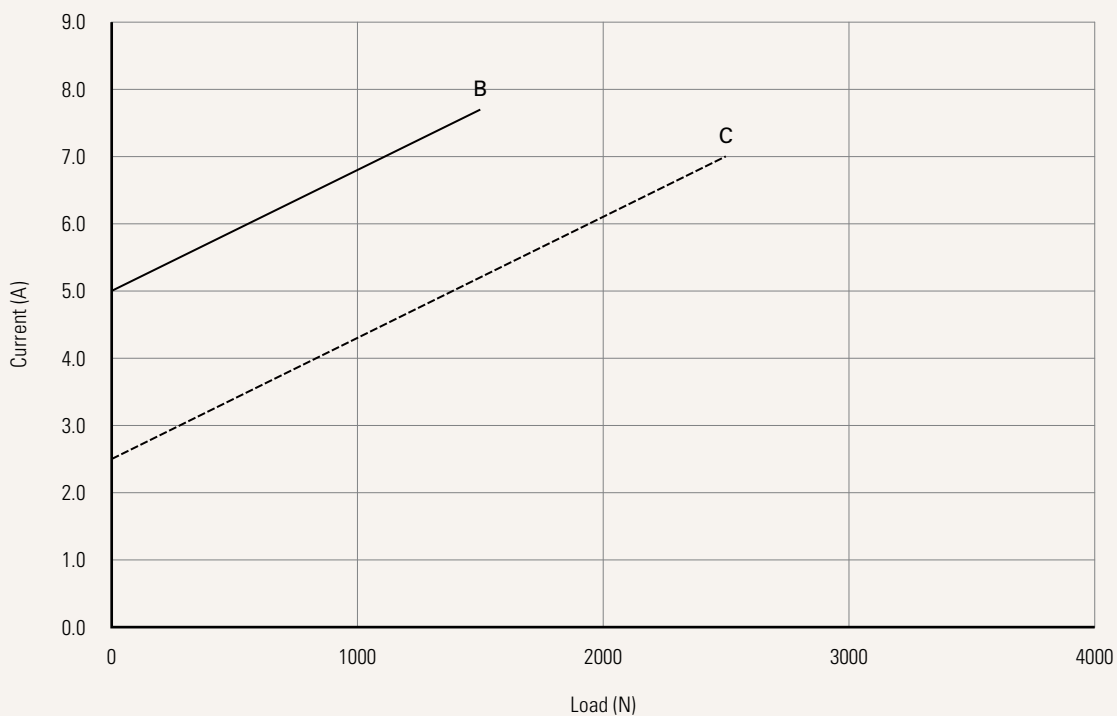

Performance Data (12V DC Motor)

ACME Screw (Duty Cycle 25%)

Speed vs. Load

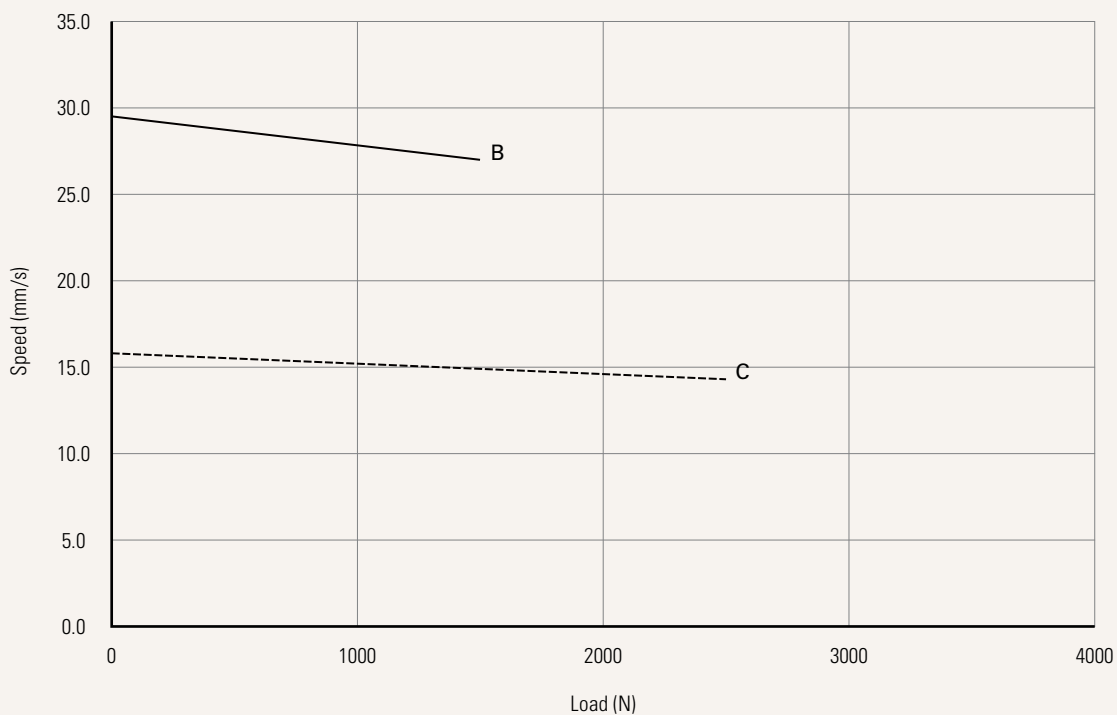

Current vs. Load

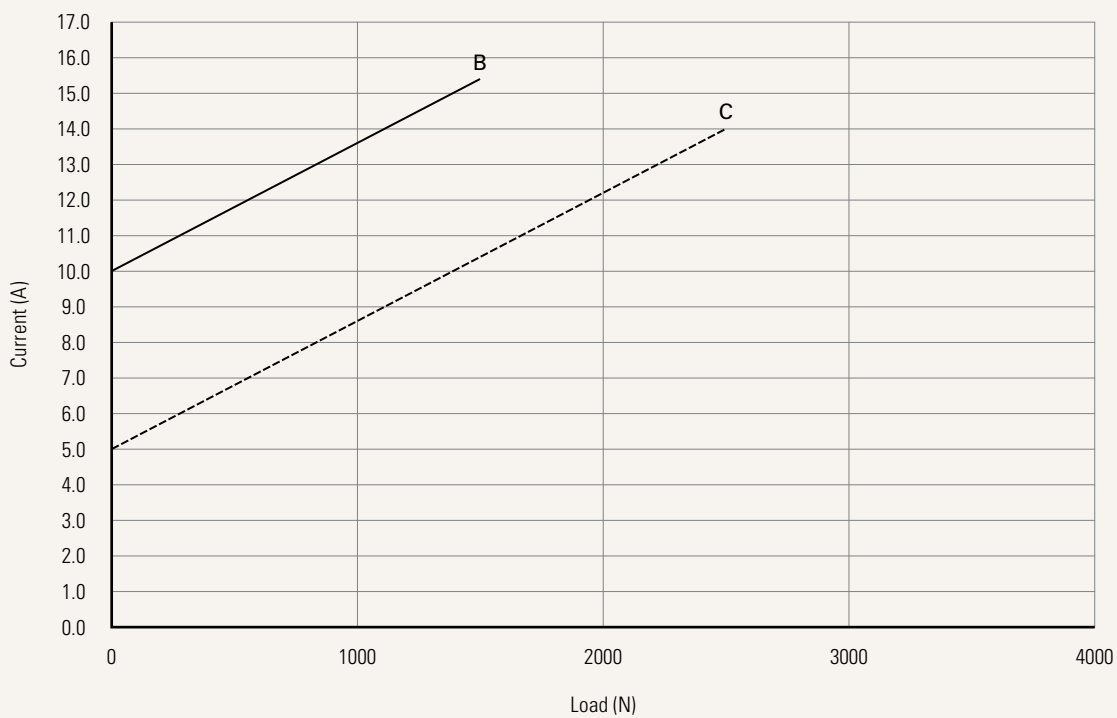

Performance Data (24V DC Motor)

Ball Screw (Duty Cycle 25%)

Speed vs. Load

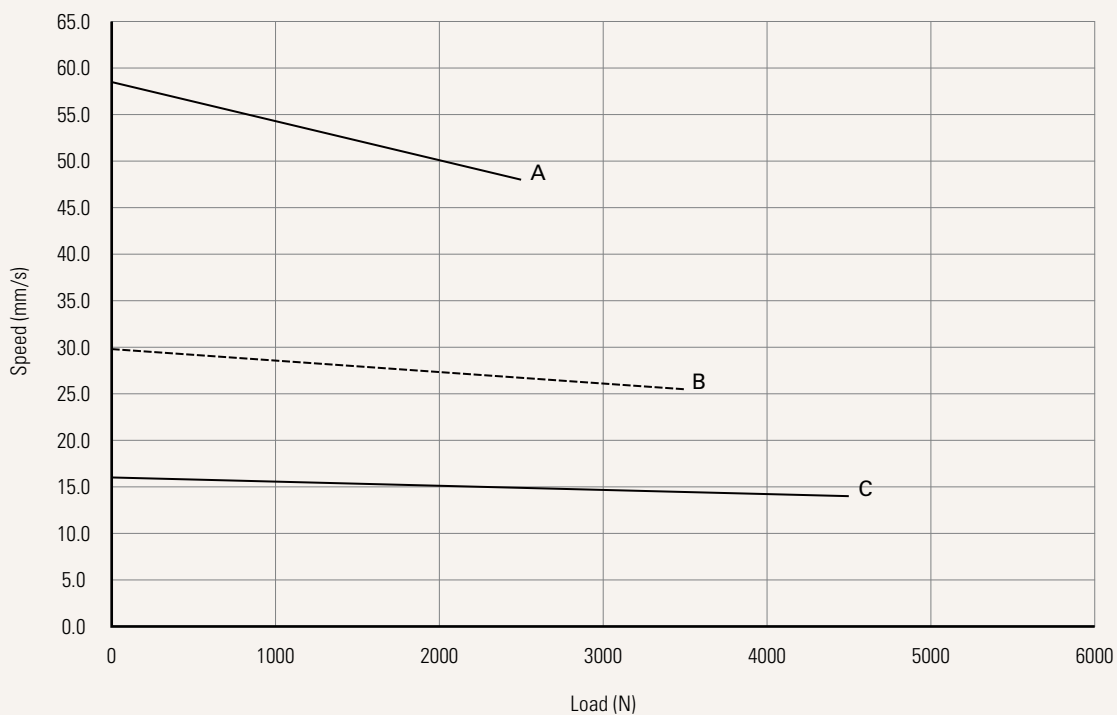

Current vs. Load

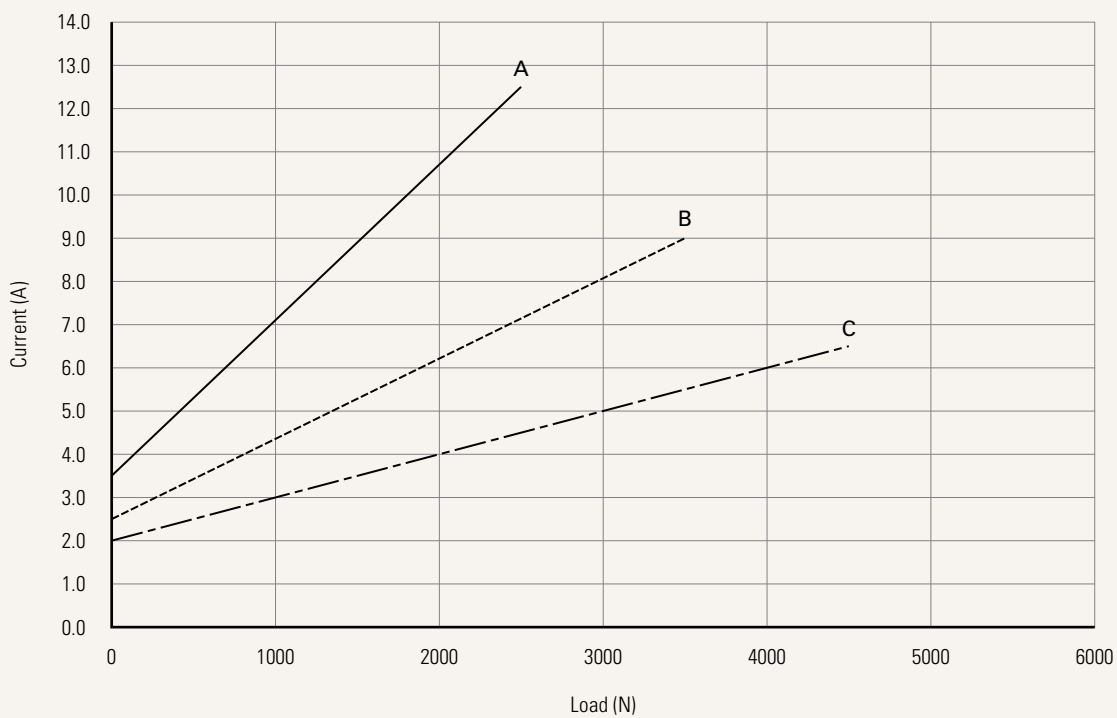

Performance Data (12V DC Motor)

Ball Screw (Duty Cycle 25%)

Speed vs. Load

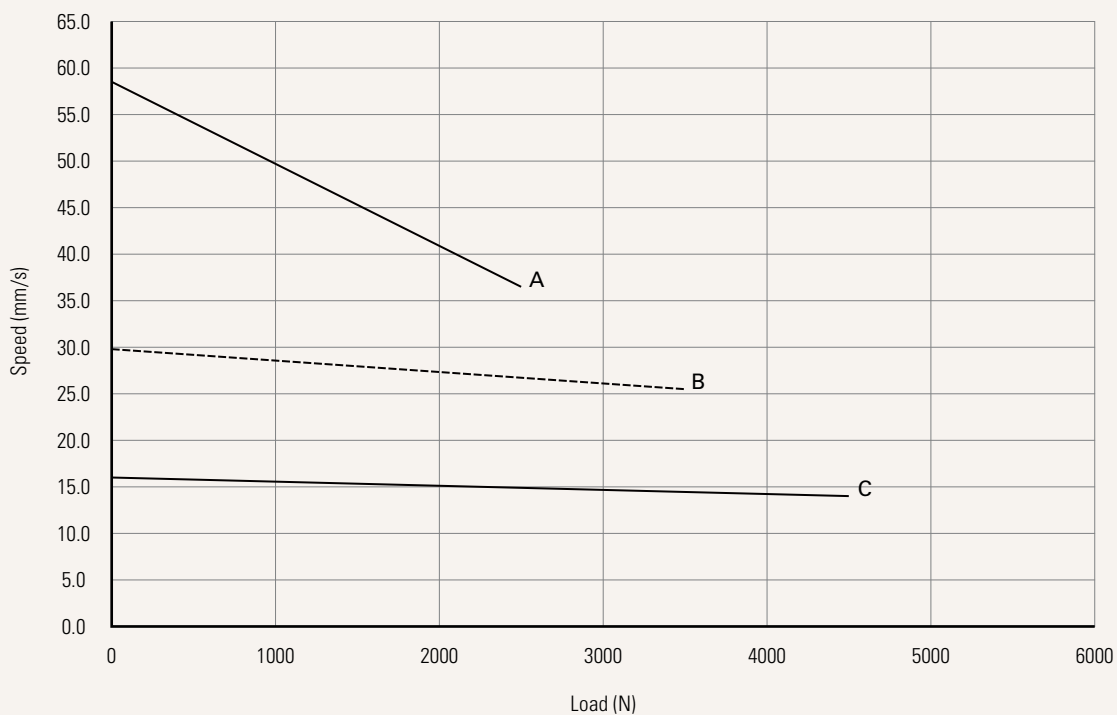

Current vs. Load

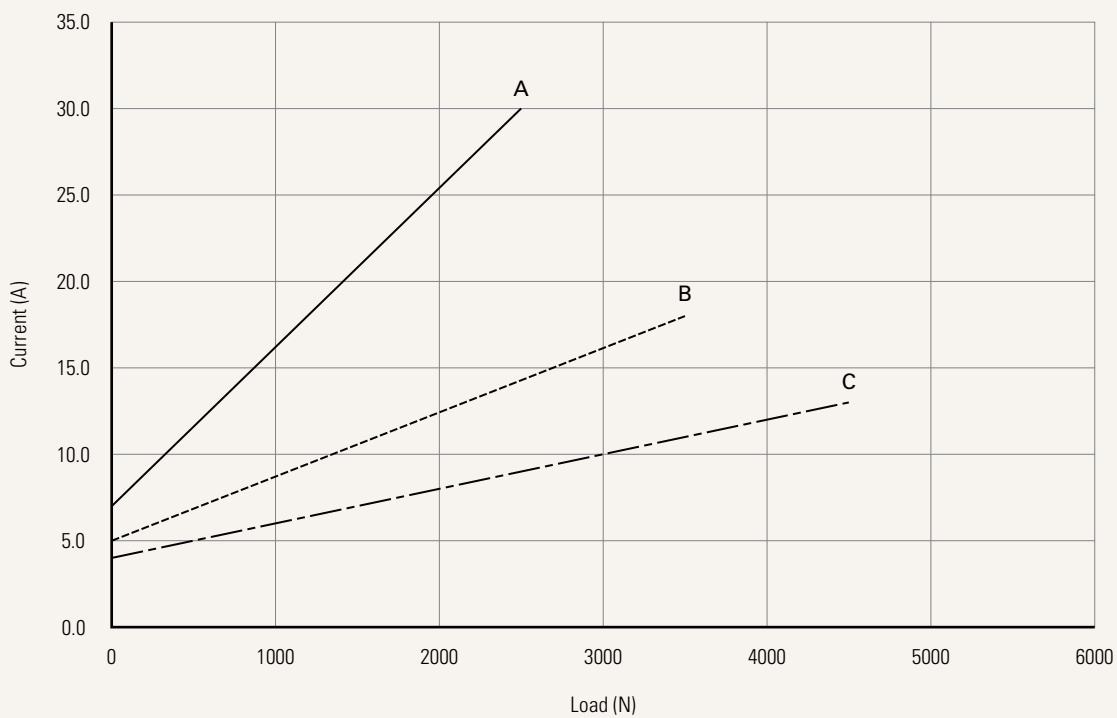

Performance Data (110V AC Motor)

ACME Screw (Duty Cycle 25%)

Speed vs. Load

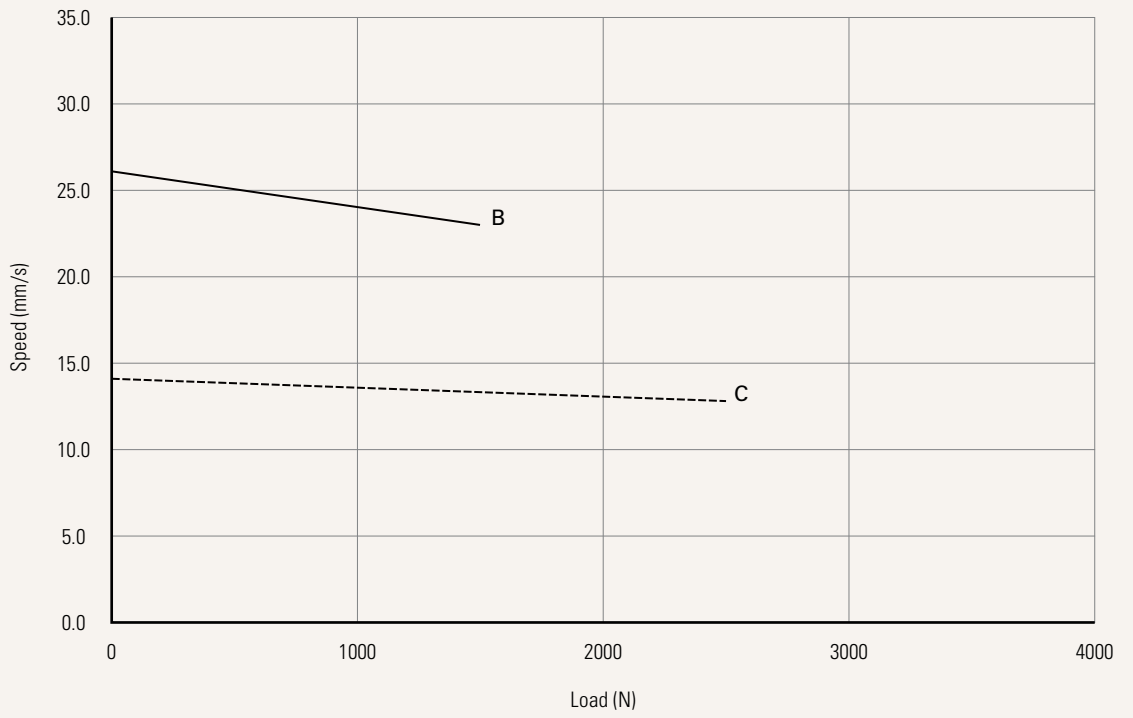

Current vs. Load

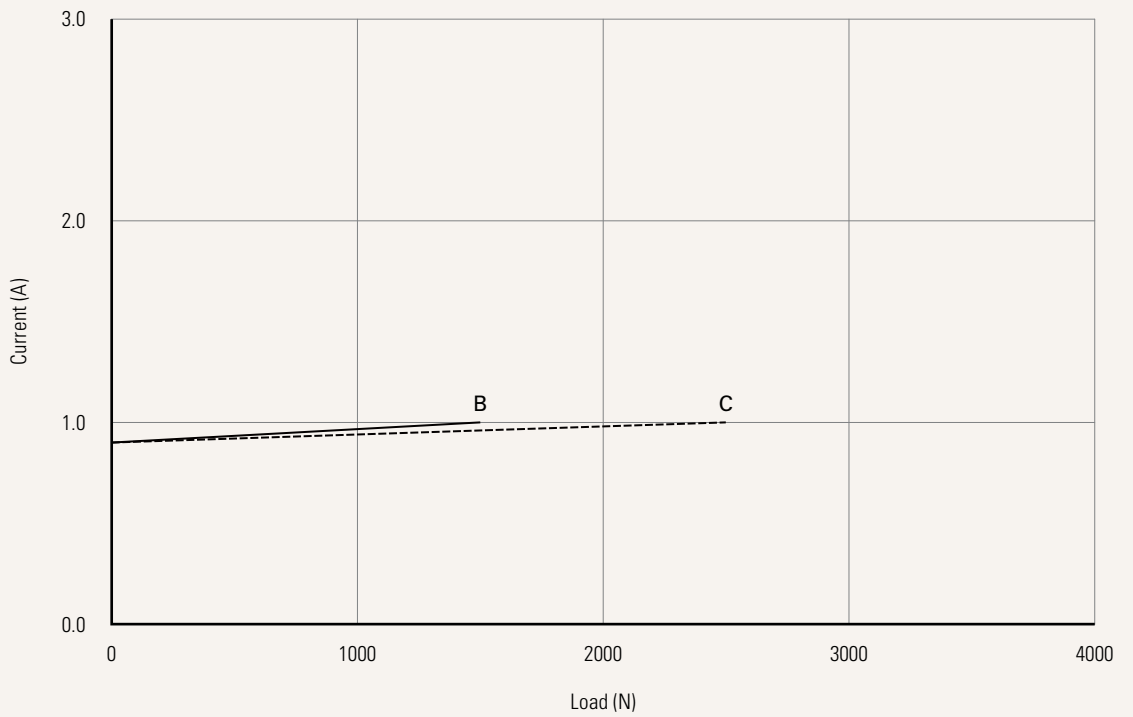

Performance Data (220V AC Motor)

ACME Screw (Duty Cycle 25%)

Speed vs. Load

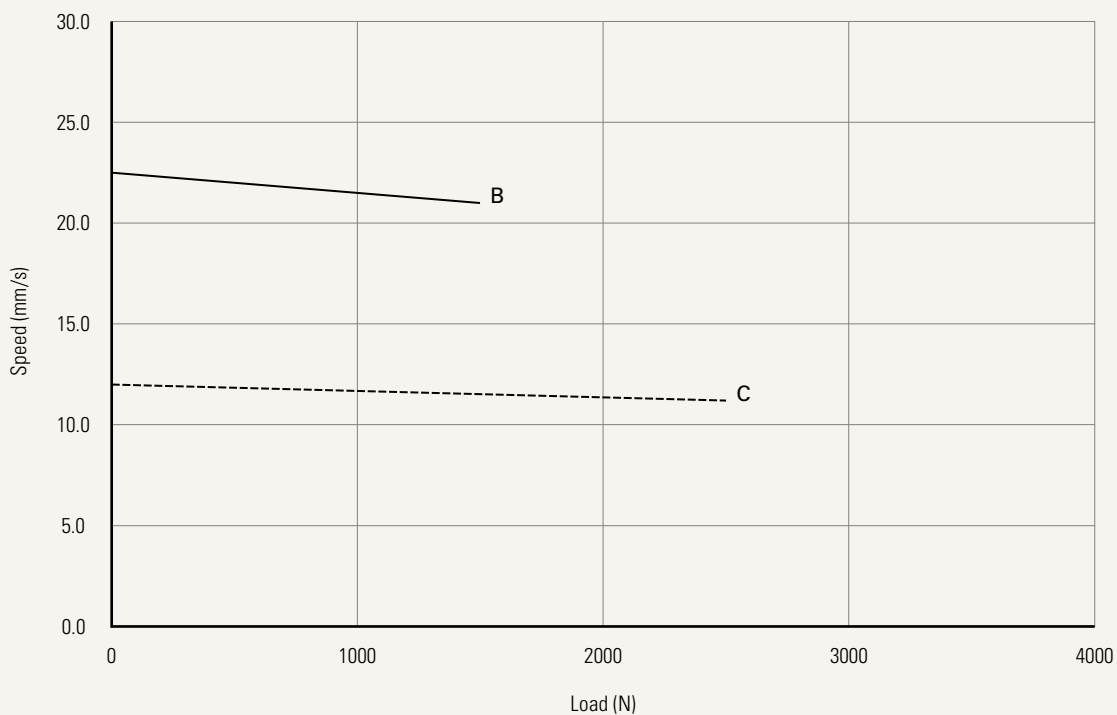

Current vs. Load

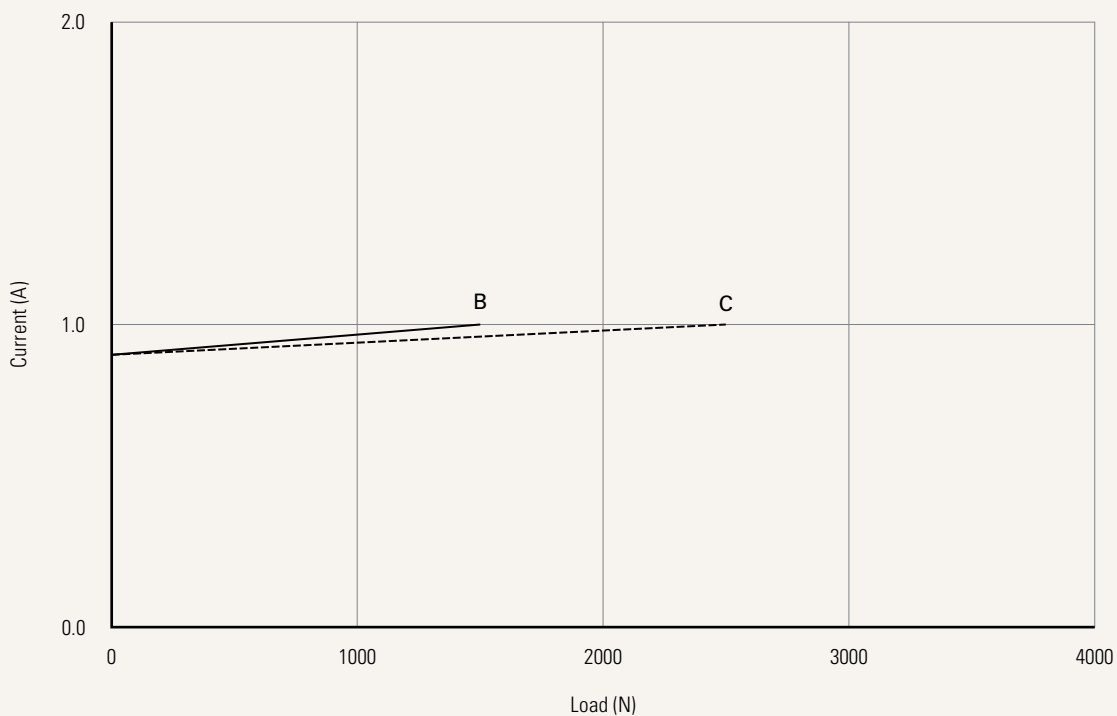

Performance Data (110V AC Motor)

Ball Screw (Duty Cycle 25%)

Speed vs. Load

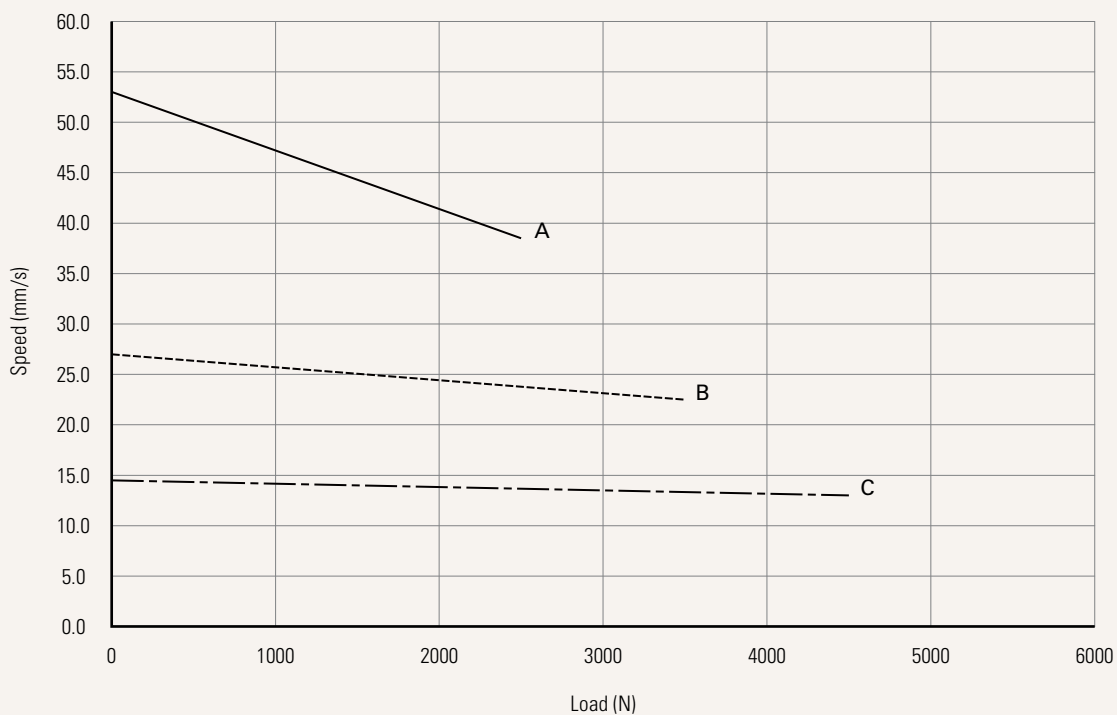

Current vs. Load

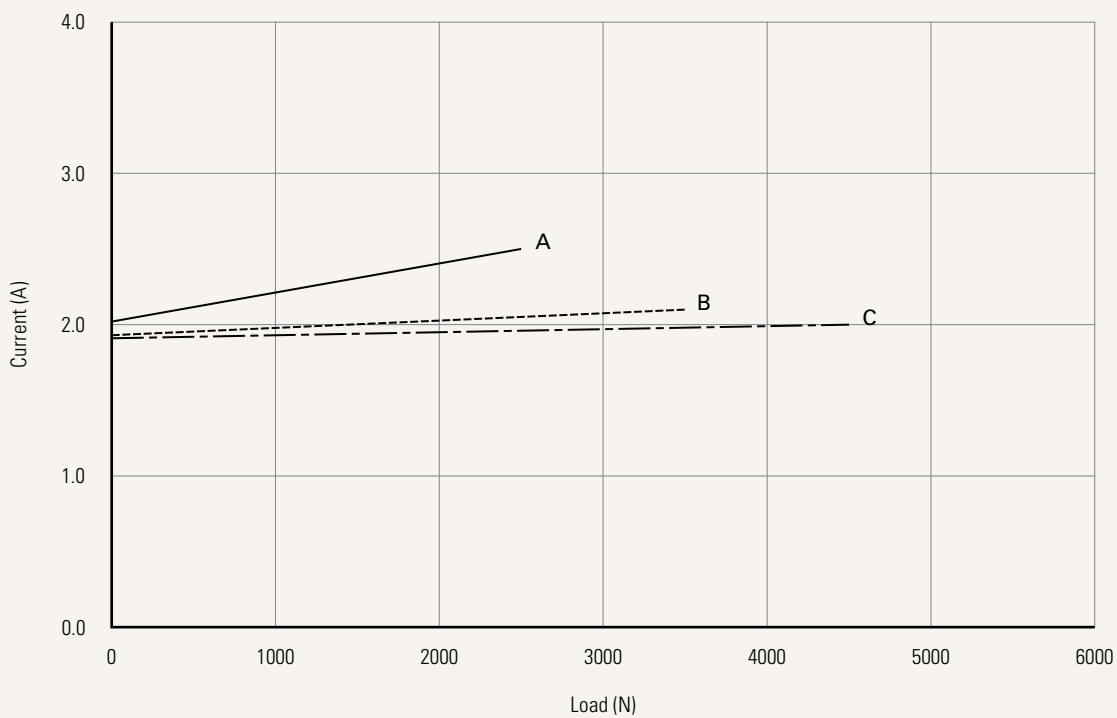

Performance Data (220V AC Motor)

Ball Screw (Duty Cycle 25%)

Speed vs. Load

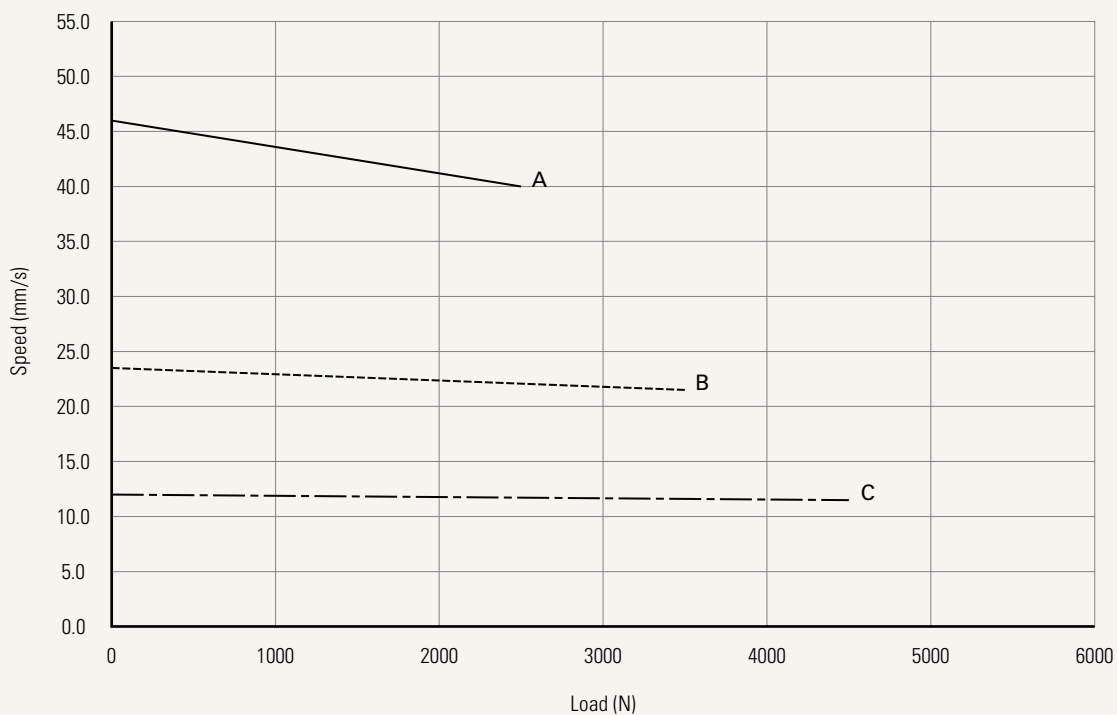

Current vs. Load

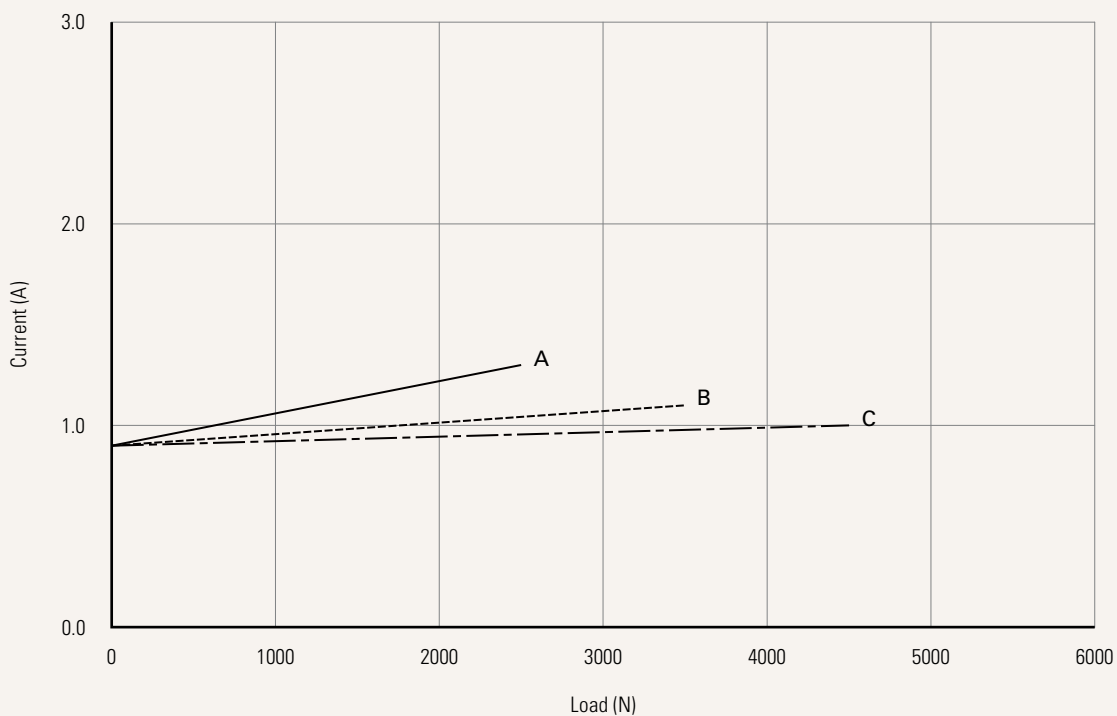

Spindle Type	A = ACME Screw	B = BALL Screw		
Voltage	1 = 12V DC 2 = 24V DC	3 = 36V DC 4 = 110V AC 60Hz	5 = 220V AC 50Hz	
Load and Speed	See page 3	See page 4		
Stroke (mm)	See page 3	See page 4		
Retracted Length (mm)	See page 14			
Rear Attachment (mm)	1 = #45 Steel CNC, without slot, hole 13.0 See page 14			
Front Attachment (mm)	1 = #45 Steel CNC, without slot, hole 13.0 See page 14			
Direction of Rear Attachment (Counterclockwise)	1 = 90° (Standard)	2 = 0° See page 15		
Functions for Limit Switches	0 = Without (Needs to choose overload clutch) 1 = Two switches at full retracted / extended positions to cut current 2 = Two switches at full retracted / extended positions to send signal			
Overload Clutch	0 = Without	1 = With		
Mechanical Brake	0 = Without	1 = With (Ball Screw's standard option) See page 15		
Electromagnetic Brake	0 = Without (Standard)	1 = With (Not support the control box with PWM speed adjustment function, such as slow start/stop or sync) See page 15		
IP Rating	6 = IP66D	8 = IP69K		
Manual Drive	0 = Without	1 = With		
Output Signals	0 = Without	1 = POT	5 = Hall sensors*2 See page 16	
Connector	1 = Tinned leads			
Cable Length (mm)	1 = Straight, 500	2 = Straight, 1000	3 = Straight, 1500	4 = Straight, 2000

Retracted Length (mm)

1. Calculate $A+B+C = Y$
2. Retracted length needs to \geq Stroke + Y

A. Type

	ACME, DC	Ball, DC	ACME, AC	Ball, AC
	+160	+201	+160	+201

C. Output Signals

	ACME, DC	Ball, DC	ACME, AC	Ball, AC
0	-	-	-	-
1	+36	+40	+36	+40
5	-	-	+36	+40

B. Mechanical Brake

	ACME, DC	Ball, DC	ACME, AC	Ball, AC
0	-	-	-	-
1	+35	-	+35	-

Rear Attachment (mm)

1 = #45 Steel CNC, without slot, hole
13.0

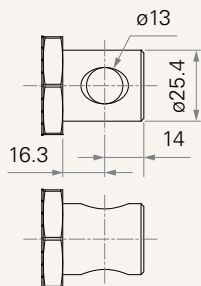

Front Attachment (mm)

1 = #45 Steel CNC, without slot, hole
13.0

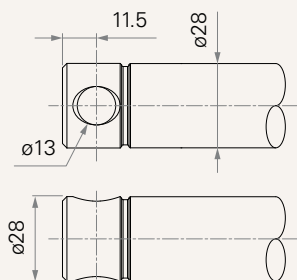

Direction of Rear Attachment (Counterclockwise)

1 = 90° (Standard)

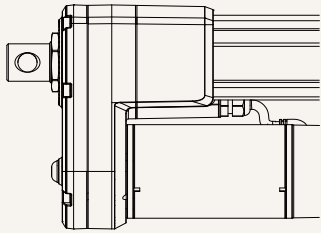

2 = 0°

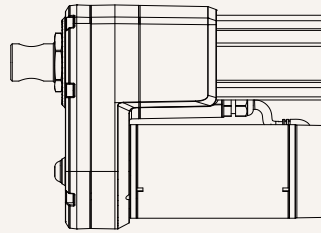

Mechanical Brake

0 = Without

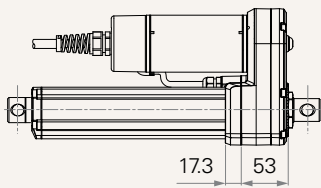

1 = With (Ball Screw's standard option)

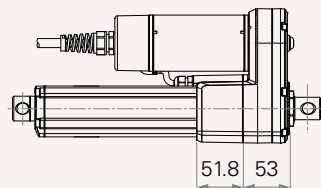

Electromagnetic Brake

0 = Without (Standard, DC)

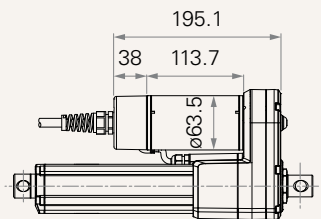

0 = Without (Standard, AC)

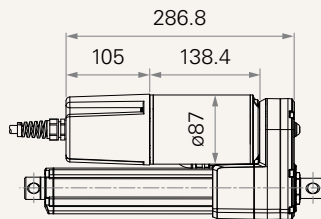

1 = With (DC)

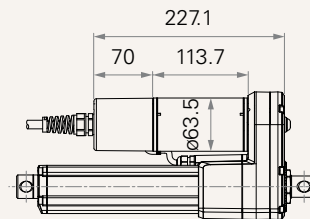

Output Signals

Wire Definitions			AWG	Output Signal Code			
				0. Without	1. POT	4. 1 Hall	5. 2 Hall
DC Motor	Motor Side	● Black	26	-	-	GND	GND
		● Blue	26	-	-	-	S2
		○ White	26	-	-	S1	S1
		● Red	26	-	-	+5V	+5V
		● Red/Green	14	Extend+	Extend+	Extend+	Extend+
		● Black/Yellow	14	Retract+	Retract+	Retract+	Retract+
	Gear Box Side	● Red	26	-	pin 1	-	-
		○ White	26	-	pin 2	-	-
		● Black	26	-	pin 3	-	-
AC Motor	Motor Side	● Black	18	Retract+	Retract+	Retract+	Retract+
		● Grey	18	Extend+	Extend+	Extend+	Extend+
		● Brown	18	PCBA+	PCBA+	PCBA+	PCBA+
		● Blue	18	Neutral	Neutral	Neutral	Neutral
		● Green/Yellow	18	GND	GND	GND	GND
		Gear Box Side	● Red	20	-	pin1	+5V
	○ White		20	-	pin2	S1	S1
	● Blue		20	-	-	-	S2
	● Black		20	-	pin3	GND	GND

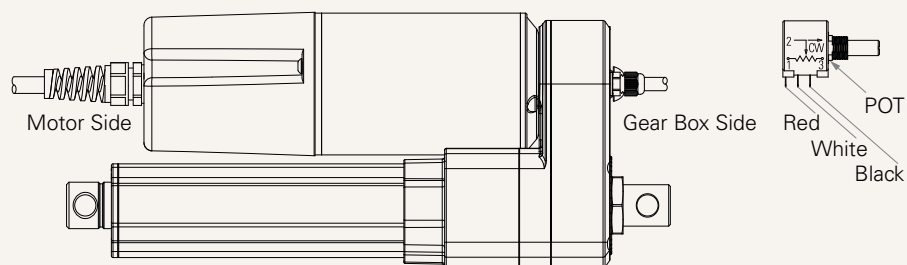

Terms of Use

The user is responsible for determining the suitability of TiMOTION products for a specific application. TiMOTION products are subject to change without prior notice.